



MODEL I530-BI SERIES

Fanless Design Industrial Box PC



Introduction

I530-BI Series Industrial Box Pc is a powerful and compact device suitable for a variety of industrial and commercial application scenarios. In outdoor environments, the mini industrial computer also has strong adaptability and reliability, providing users with convenient operation methods and work efficiency. I530-BI supports WINDOWS/LINUX operating system. It has Intel Celeron/Core 4-13th generation processor. Support 3G, 4G, Wifi, Bluetooth dual communication modules.



Specification

Mother Board Specification

I530-BI Series											
Model	I530-BI(1)		I530-BI(2)		I530-BI(3)			I530-BI(4E)		I530-BI(6C)	
CPU	J1900 N2840 i3-5005U i5-4300U 5300U i7-4600U 5600U	J6412	N95 N100	i3-6167U 7020U i5-7287U	i3-8130U 10110U i5-8350U 10310U 1135G7 i7-8665U 10610U 1195G7	i3-1215U i5-1235U i7-1355U	J6412	N100	J6412	N95 N100	
Memory	1*DDR3 Up to 8GB		1*DDR4 Up to 16GB		1*DDR4 Up to 16GB	2*DDR4 Up to 32GB	1*DDR5 Up to 48GB	1*DDR4 Up to 16GB			
Storage	1*MSATA SSD Slot		1*M.2 NVME SSD					1*MSATA SSD Slot	1*M.2 NVME SSD		
	1*SATA SSD Slot										
Display	1*HDMI: Res. Up to 3280*2000 @60Hz 1*VGA: Res. Up to 1920*1200 @60Hz	2*HDMI: Res. Up to 4096*2160 @60Hz 1*DP: Res. Up to 4096*2160 @60Hz		1*HDMI: Res. Up to 4096*2160 @60Hz 1*VGA: Res. Up to 1920*1200 @60Hz			1*HDMI: Res. Up to 4096*2160 @60Hz 1*DP: Res. Up to 4096*2160 @60Hz		2*HDMI: Res. Up to 4096*2160 @60Hz 1*DP: Res. Up to 4096*2160 @60Hz		
Expansion	1*Mini-PCIE	2*Mini PCIE	2*M.2	1*Mini-PCIE			1*Mini PCIE + 1*M.2	1*M.2 Slot	2*Mini PCIE	2*M.2	
Ethernet	2*Realtek 8111E LAN chip (10 / 100 / 1000 Mbps, RJ-45)						4*Intel I225V LAN Chip		2*Realtek 8111E LAN		
USB	5*USB 2.0 1*USB 3.0	4*USB 3.0		4*USB 2.0 4*USB 3.0			4*USB 2.0 2*USB 3.0		4*USB 3.0		
COM	2*RS-232 / 485 (DB9 type)			1*RS-232 (DB9 type) 1*RS-232 (Phoenix terminal type)			1*RS-232 (DB9 type) 1*RS-232 (Phoenix terminal type)		2*RS-232 / 485 4*RS-232 (Phoenix Terminal Type)		



I530-BI Series					
Model	I530-BI(1)	I530-BI(2)	I530-BI(3)	I530-BI(4E)	I530-BI(6C)
Audio	1*Line-out	1*Line-Out	1*Line-In 1*Line-Out	----	1*Line-Out

Device Specification

I530-BI Series					
Model	I530-BI(1)	I530-BI(2)	I530-BI(3)	I530-BI(4E)	I530-BI(6C)
BIOS	AMI UEFI BIOS				
Power Input	DC 12V			DC 9-36V	
	Support Auto-Start				
	1*2.5mm circle type DC plug	1*2 Pin Phoenix Terminal Type DC Plug	1*2.5mm circle type DC plug		1*2 Pin Phoenix Terminal Type DC Plug
Working Temperature	-20°C - 70°C , Support 24/7 Working				
Storage Temperature	-30°C - 80°C				
Humidity	90% (20±50°C)				
Size	159.6mm*127mm*53mm				
Structure	Fully Enclosed Aluminum Alloy Material				
Heat dissipation	Fanless Design, Conduction Heat Dissipation				
	Fan design Chassis (optional)				
Installation	Desktop / Embedded / Wall-Mounted				
System	Low than 8th CPU: Windows 7 / 8 / 10 and Linux				
	More than 8th CPU: Windows 10 / 11 and Linux				



Ordering Information

Model	CPU	LAN	USB	COM	Display	RAM	SSD	Expansion	Power
I530-BI(1)	J1900	2	6	2*RS-232	1*HDMI 1*VGA	1*DDR 3 Up to 8GB	1*MSATA 1*SATA	1*Mini PCIE	DC 12V
	N2840								
	4th/5th								
I530-BI(2)	N95	2	4	2*RS-232/485	2*HDMI 1*DP	1*DDR 4 Up to 16GB	1*M.2 NVME 1*SATA	2*M.2	
	N100						1*MSATA 1*SATA	2*Mini PCIE	
	J6412								
I530-BI(3)	6th/7th	2	8	2*RS-232	1*HDMI 1*VGA	1*DDR 4 Up to 16GB	1*M.2 NVME 1*SATA	1*Mini PCIE	
	8th/10th					2*DDR 4 Up to 32GB			
	11th/12th/13th					1*DDR 5 Up to 32GB			
I530-BI(4E)	J6412	4	6	2*RS-232	1*HDMI 1*DP	1*DDR 4 Up to 16GB	1*M.2 NVME 1*SATA	1*Mini PCIE 1*M.2	
	N100						1*MSATA 1*SATA	1*M.2	
I530-BI(6C)	N95	2	4	2*RS-232/485 4*RS-232	2*HDMI 1*DP	1*DDR 4 Up to 16GB	1*M.2 NVME 1*SATA	2*M.2	DC 9-36V
	N100						1*MSATA 1*SATA	2*Mini PCIE	
	J6412								

System Information

CPU	Specification
J1900 / N2840	Windows 7 / 10 and Linux
4th / 5th / 6th / 7th	
N95 / N100 / J6412	Windows 10 / 11 and Linux
8th / 10th / 11th / 12th / 13th	



CPU Information

CPU	Core	Threads	Frequency	Cache	Graphics
J1900	4	4	2.00-2.42GHz	2MB	HD Graphics
J6412	4	4	2.00-2.60GHz	1.5 MB	UHD Graphics
N95	4	4	3.40GHz	6 MB	UHD Graphics
N100	4	4	3.40GHz	6 MB	UHD Graphics
N2840	2	2	2.16-2.58GHz	1 MB	HD Graphics
i5-4300U	2	4	1.90-2.90GHz	3 MB	HD Graphics 4400
i7-4600U	2	4	2.10-3.30GHz	4 MB	HD Graphics 4400
i3-5005U	2	4	2.0GHz	3 MB	HD Graphics 5500
i5-5300U	2	4	2.30-2.90GHz	3 MB	HD Graphics 5500
i7-5600U	2	4	2.60-3.20GHz	4 MB	HD Graphics 5500
i3-6157U	2	4	2.40GHz	3 MB	Iris® Graphics 550
i3-7020U	2	4	2.30GHz	3 MB	HD Graphics 620
i5-7287U	2	4	3.30-3.70GHz	4 MB	Iris® Plus Graphics 650
i3-8130U	2	4	2.20-3.40GHz	4 MB	UHD Graphics 620
i5-8350U	4	8	1.70-3.60GHz	6 MB	UHD Graphics 620
i7-8665U	4	8	1.90-4.80GHz	8 MB	UHD Graphics
i3-10110U	2	4	2.10-4.10GHz	4 MB	UHD Graphics
i5-10310U	4	8	1.70-4.40GHz	6 MB	UHD Graphics
i7-10610U	4	8	1.80-4.90GHz	8 MB	UHD Graphics
i5-1135G7	4	8	2.40-4.20GHz	8 MB	Iris Xe Graphics
i7-1195G7	4	8	2.90-5.00GHz	12 MB	Iris Xe Graphics
i3-1215U	6	8	1.20-4.40GHz	10 MB	UHD Graphics
i5-1235U	10	12	1.30-4.40GHz	12 MB	Iris Xe Graphics
i7-1280P	14	20	1.80-4.80GHz	24 MB	Iris Xe Graphics
i7-1355U	10	12	1.70-5.00GHz	12 MB	Iris Xe Graphics



Fittings Information

MODEL I530-BI(1)		
RAM	DDR3	4GB / 8GB
Storage	MSATA	64GB / 128GB / 256GB / 512GB / 1TB
	SATA	120GB / 128GB / 240GB / 256GB / 480GB / 512GB / 960GB / 1TB / 2TB / 4TB
GSM Module	4G	4G+GPS
WIFI Module	7260AC / AX210	
MODEL I530-BI(2)		
RAM	DDR4	4GB / 8GB / 16GB
Storage	MSATA	64GB / 128GB / 256GB / 512GB / 1TB
	M.2 NVME	128GB / 256GB / 512GB / 1TB / 2TB / 4TB
	SATA	120GB / 128GB / 240GB / 256GB / 480GB / 512GB / 960GB / 1TB / 2TB / 4TB
GSM Module	4G	4G+GPS
	5G	5G+GPS
WIFI Module	7260AC / AX210	
MODEL I530-BI(3)		
RAM	DDR4	4GB / 8GB / 16GB / 32GB
	DDR5	4GB / 8GB / 16GB / 32GB / 48GB
Storage	M.2 NVME	128GB / 256GB / 512GB / 1TB / 2TB / 4TB
	SATA	120GB / 128GB / 240GB / 256GB / 480GB / 512GB / 960GB / 1TB / 2TB / 4TB
GSM Module	4G	4G+GPS
WIFI Module	7260AC / AX210	
MODEL I530-BI(4E)		
RAM	DDR4	4GB / 8GB / 16GB
Storage	M.2 NVME	128GB / 256GB / 512GB / 1TB / 2TB / 4TB
	SATA	120GB / 128GB / 240GB / 256GB / 480GB / 512GB / 960GB / 1TB / 2TB / 4TB
GSM Module	4G	4G+GPS
WIFI Module	7260AC / AX210	



MODEL I530-BI(6C)		
RAM	DDR4	4GB / 8GB / 16GB
Storage	MSATA	64GB / 128GB / 256GB / 512GB / 1TB
	M.2 NVME	128GB / 256GB / 512GB / 1TB / 2TB / 4TB
	SATA	120GB / 128GB / 240GB / 256GB / 480GB / 512GB / 960GB / 1TB / 2TB / 4TB
GSM Module	4G	4G+GPS
	5G	5G+GPS
WIFI Module	7260AC / AX210	

Package List

MODEL	Adapter	Power Cable
I530-BI(1)	1*12V 5A Adapter	1*Power Cable
I530-BI(2)	1*12V 5A Adapter	1*Power Cable
I530-BI(3)	1*12V 5A adapter	1*Power Cable
I530-BI(4E)	1*12V 5A adapter	1*Power Cable
I530-BI(6C)	1*12V 5A adapter	1*Power Cable

Classis with Fan and Fanless

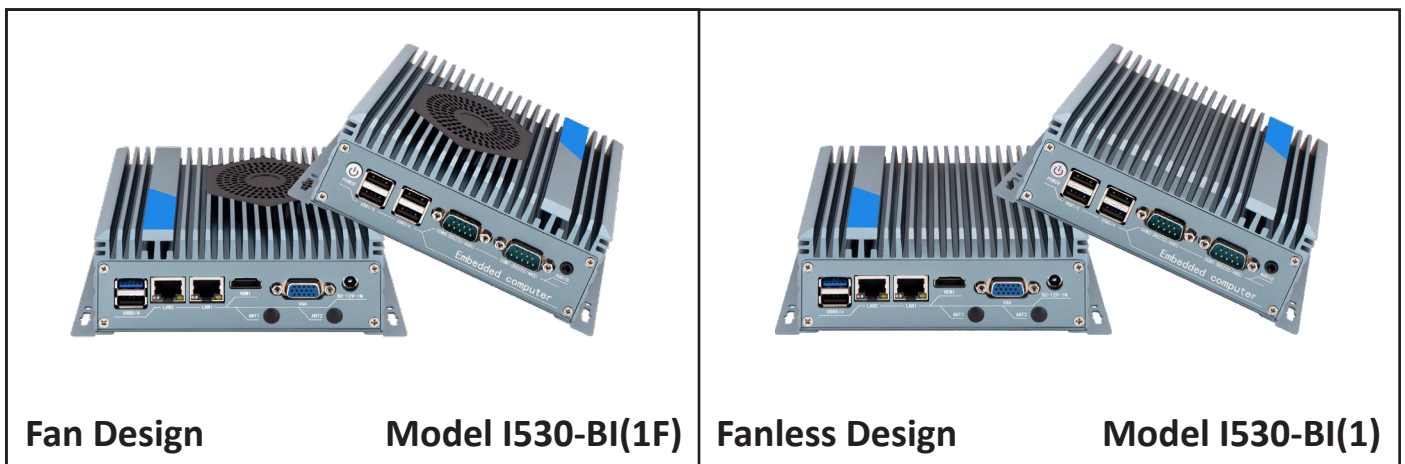

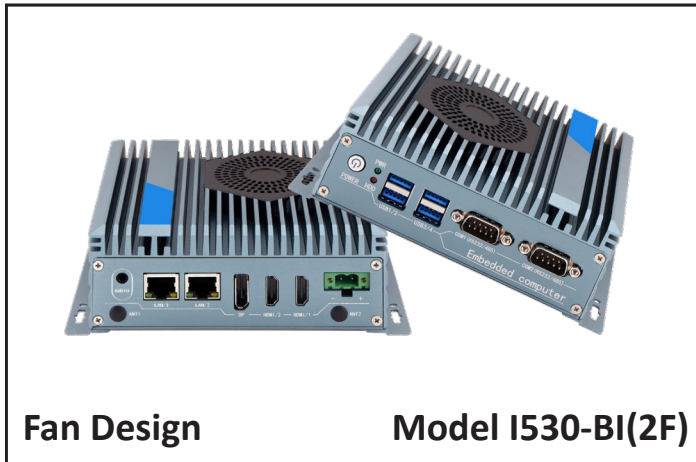

Fan Design

Model I530-BI(2F)

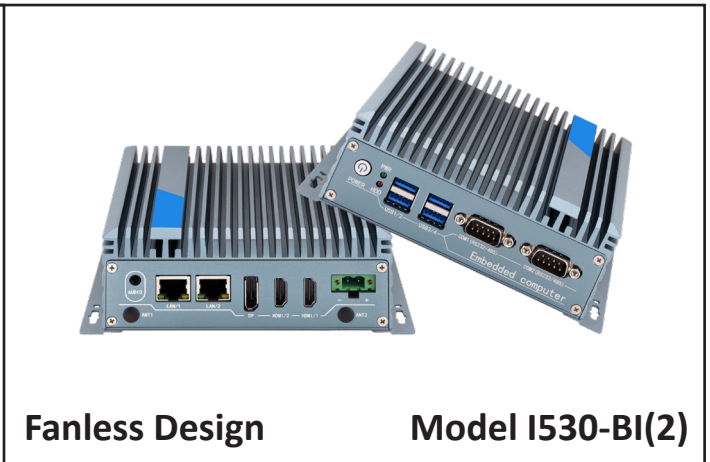

Fanless Design

Model I530-BI(2)

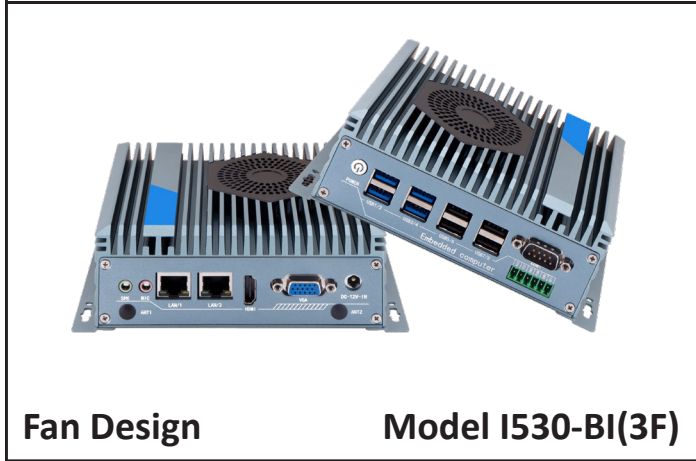

Fan Design

Model I530-BI(3F)

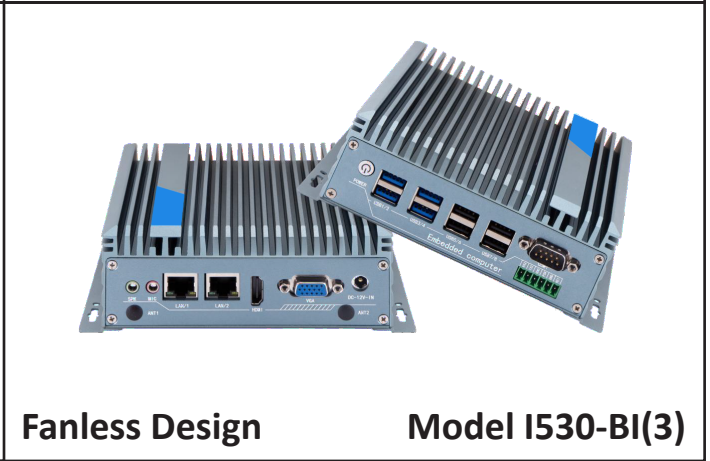

Fanless Design

Model I530-BI(3)



Fan Design

Model I530-BI(4EF)

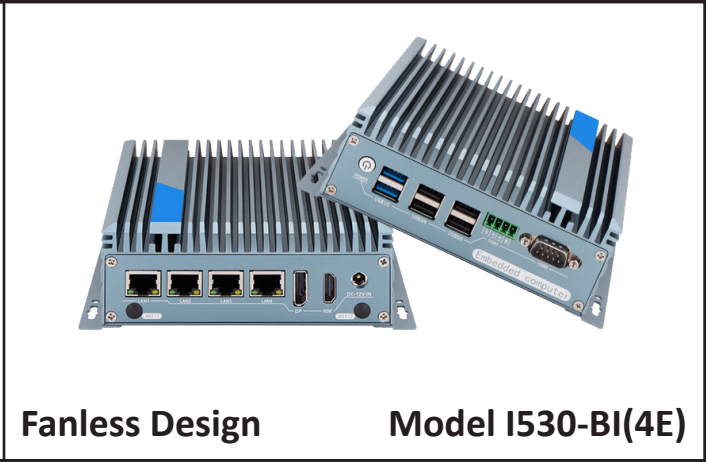

Fanless Design

Model I530-BI(4E)



Fan Design

Model I530-BI(6CF)

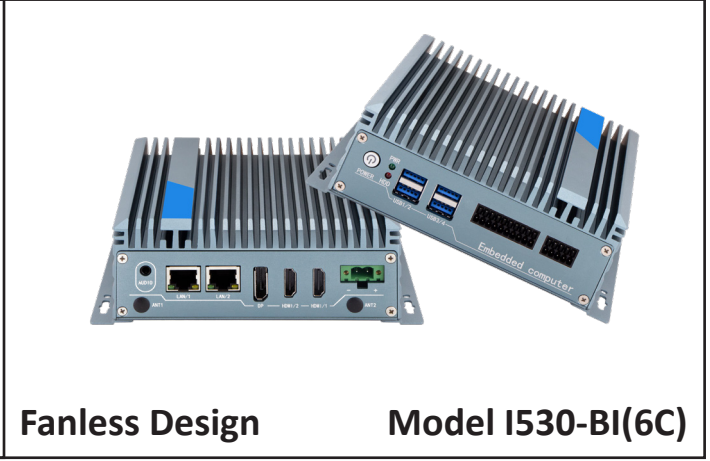

Fanless Design

Model I530-BI(6C)



I/O Port

Model. I530-BI(1)

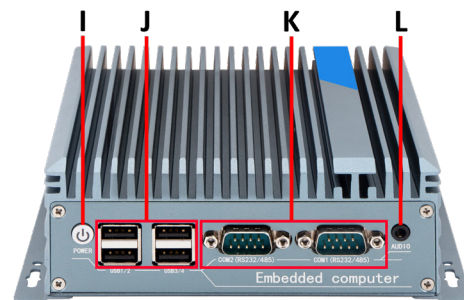
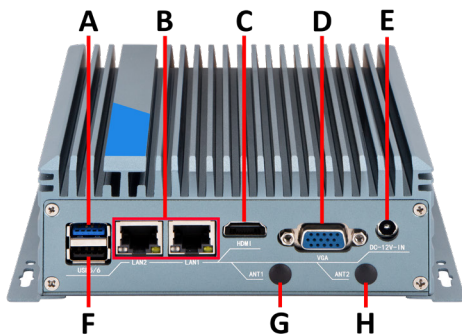

- A** : USB3.0 x1
- B** : LAN x2
- C** : HDMI x1
- D** : VGA x1

- E** : DC IN x1
- F** : USB2.0 x1
- G** : ANT x1
- H** : ANT x1

- I** : Power x1
- J** : USB2.0 x4
- K** : COM x2
- L** : AUDIO x1

Model. I530-BI(2)

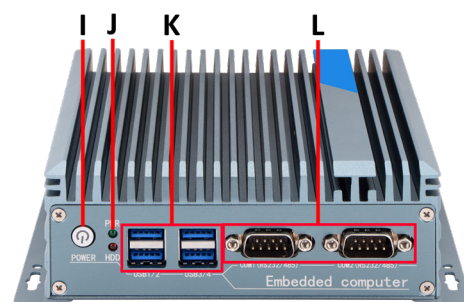
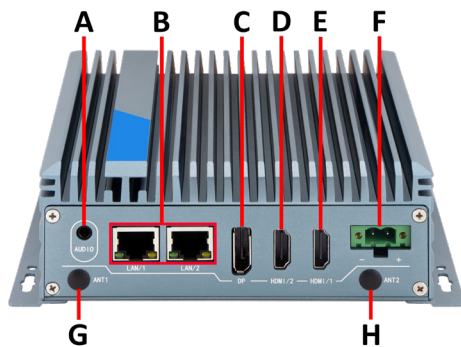

- A** : Audio x1
- B** : LAN x2
- C** : DP x1
- D** : HDMI x1

- E** : HDMI x1
- F** : DC IN x1
- G** : ANT x1
- H** : ANT x1

- I** : Power x1
- J** : HDD/PWR Poilct lamp
- K** : USB3.0 x4
- L** : COM x2



Model. I530-BI(3)

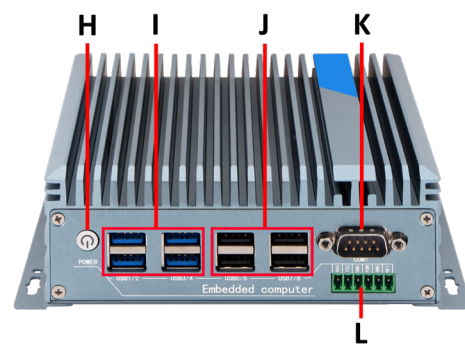
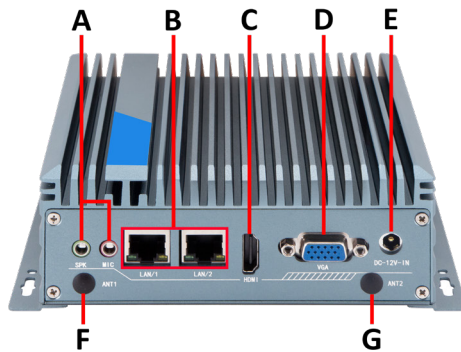

- | | | |
|-------------------------|---------------------|---|
| A : SPK + MIC x1 | E : DC IN x1 | I : USB3.0 x4 |
| B : LAN x2 | F : ANT x1 | J : USB2.0 x4 |
| C : HDMI x1 | G : ANT x1 | K : COM x1 |
| D : VGA x1 | H : Power x1 | L : COM x1 (Phoenix Terminal Type) |

Model. I530-BI(4E)

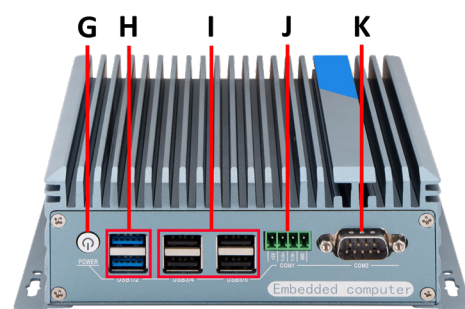
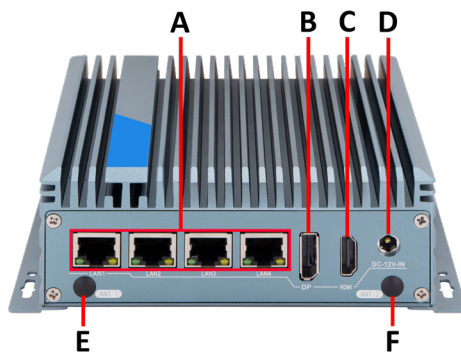

- | | | |
|---------------------|----------------------|---|
| A : LAN x4 | E : ANT x1 | I : USB2.0 x4 |
| B : DP x1 | F : ANT x1 | J : COM x1 (Phoenix Terminal Type) |
| C : HDMI x1 | G : Power x1 | K : COM x1 |
| D : DC IN x1 | H : USB3.0 x2 | |

Model. I530-BI(6C)

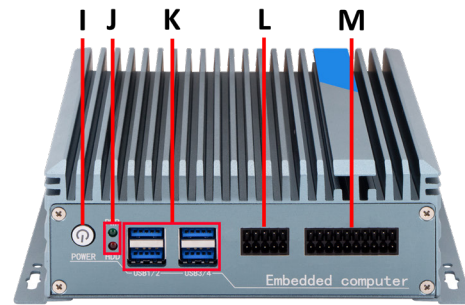
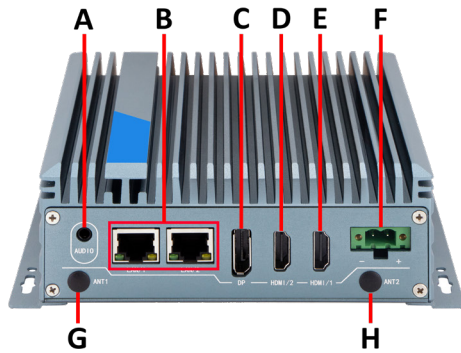

- A** : Audio x1
- B** : LAN x2
- C** : DP x1
- D** : HDMI x1

- E** : HDMI x1
- F** : DC IN x1
- G** : ANT x1
- H** : ANT x1

- I** : Power x1
- J** : HDD/PWR Poilct lamp x1
- K** : USB3.0 x4
- L** : COM x2 (Phoenix Terminal Type)
- M** : COM x4 (Phoenix Terminal Type)

Dimensions

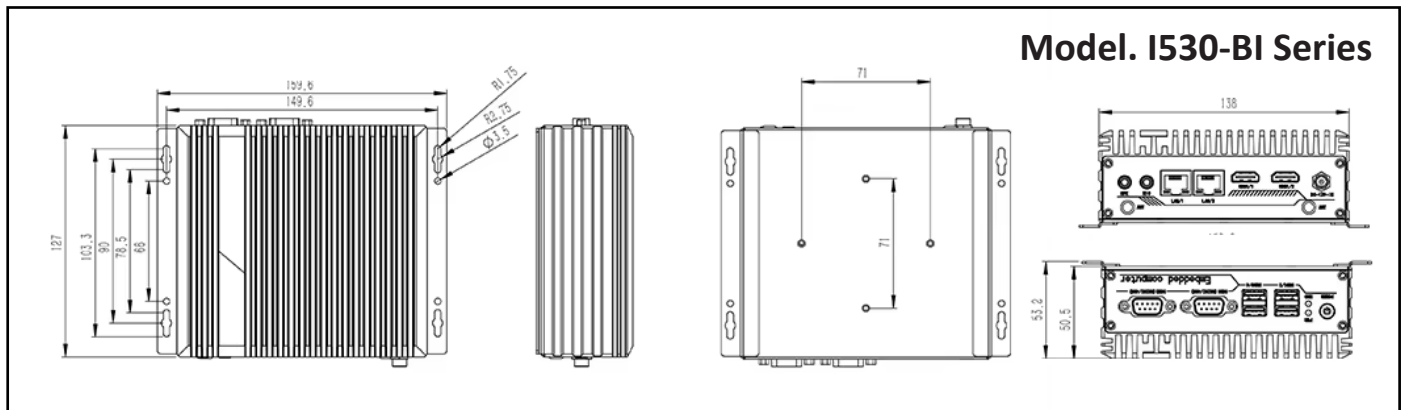

Applications



Industrial Factory



Industrial Robot

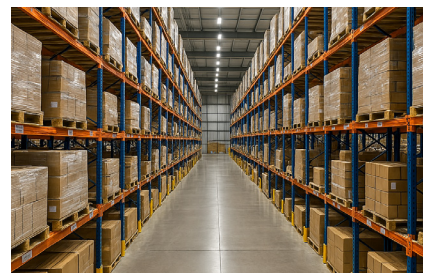

WareHouse

