



# Saline C™ 6.0

Commercial Salt Chlorine Generator

## Owner's Manual



### Contents

Description.....	3
Installation.....	4
Operation.....	7
Maintenance.....	8
Parts Guide.....	9
Warranty.....	11



3101970  
Conforms to UL 1081 and  
CSA, C22.2 #218.1

HCSC60

## IMPORTANT SAFETY INSTRUCTIONS

Basic safety precautions should always be followed, including the following: Failure to follow instructions can cause severe injury and/or death.

**⚠** This is the safety-alert symbol. When you see this symbol on your equipment or in this manual, look for one of the following signal words and be alert to the potential for personal injury.

**⚠ WARNING** warns about hazards that could cause serious personal injury, death or major property damage and if ignored presents a potential hazard.

**⚠ CAUTION** warns about hazards that will or can cause minor or moderate personal injury and/or property damage and if ignored presents a potential hazard. It can also make consumers aware of actions that are unpredictable and unsafe.

The **NOTICE** label indicates special instructions that are important but not related to hazards.

Hayward Commercial Pool Products  
10101 Molecular Drive, Suite 200  
Rockville, MD 20850  
Phone: (800) 657-2287  
[www.haywardcommercialpool.com](http://www.haywardcommercialpool.com)



# HAYWARD®

## IMPORTANT SAFETY INSTRUCTIONS

**⚠ WARNING** Read, understand, and follow all safety and operation instructions.

Failure to follow safety and operation instructions can result in severe personal injury or death.

**⚠ WARNING** -Risk of Electric Shock. Hazardous voltage can, shock, burn and cause death or serious property damage. To reduce the risk of electrical shock, connect the equipment assembly to a circuit protected by a ground-fault circuit-interrupter. Do not bury cord. If cord is damaged, replace immediately.

**⚠ WARNING** – When installing the system, ensure that power is interlocked with the main recirculation pump power source for the pool/spa to ensure that the Saline C 6.0 system cannot operate when the pumps are off.

**⚠ WARNING Chemical Hazard.** Chemicals can cause burns both internally and externally. To avoid death, serious injury or property damage: Wear eye and skin protection while maintaining or servicing this unit. Do not inhale fumes from the unit.

**⚠ CAUTION** To reduce risk of injury, do not permit children to use or climb on this product. Closely supervise children at all times. The ANSI/NSPI-4 Standard (above-ground and on-ground pools) advises that components such as the this system, filtration system, pumps, and heaters be positioned to prevent their being used as a means of access to the pool by young children.

**⚠ WARNING – Hazardous Pressure.** Pool and spa water circulation systems operate under hazardous pressure during start up, normal operation, and after pump shut off. Stand clear of circulation system equipment during pump start up. Failure to follow safety and operation instructions could result in violent separation of the pump housing and cover, and/or filter housing and clamp due to pressure in the system, which could cause property damage, severe personal injury, or death. Before servicing pool and spa water circulation system, all system and pump controls must be in off position and filter manual air relief valve must be in open position. Before starting system pump, all system valves must be set in a position to allow system water to return back to the pool. Do not change filter control valve position while system pump is running. Before starting system pump, fully open filter manual air relief valve. Do not close filter manual air relief valve until a steady stream of water (not air or air and water) is discharged.

**Notice:** This product should be installed and serviced only by a qualified pool professional.

### SAVE THESE INSTRUCTIONS



## DESCRIPTION

### General Information

The Saline C 6.0 is a saline chlorination system designed for commercial swimming pool applications. The Saline C 6.0 is certified to produce 5 pounds of equivalent chlorine per day (based on 3500 ppm of salt). The system produces chlorine continuously from a salt concentration of 3500 ppm to 5000 ppm added to the pool. The Saline C 6.0 is designed for commercial service and can be operated 24 hours a day and/or controlled by any pool controller. All models are reverse polarity for self cleaning and reduced cell maintenance.

### Electrolytic Cell Assembly

The electrolytic cell assembly consists of a clear cell vessel containing an electrolytic cell made from precious metal coated cell plates. Pool water from the pool circulation system is directed through the cell. The pool water, maintained between 3500 and 5000 ppm salt concentration is converted in the electrolytic cell to free chlorine. The free chlorine is then circulated to the pool and combines with organics and further combines to form salt to be used again by the electrolytic cell. This is called a closed loop system because the salt is used repeatedly and is only lost through splash-out, backwashing, leaks and rainfall.

### Power Supply and Control Box

The power supply provides the current to the electrolytic cells to produce the rated amount of sodium hypochlorite. The power supply houses all the safety features to prevent system operation in the event of a malfunction.

### General Specifications

Model Designation	Part Number	Sodium Hypochlorite Production (lbs/day)	Rated Power in DC Amps	Rated Pressure	Minimum Water Flow Rate (gpm)	Maximum Water Flow Rate (gpm)	Inlet Diameter (Inches)	Outlet Diameter (Inches)
Saline C 6.0	HCSC60	5.0lbs/day@ 3500 ppm	36	50 psi	40 gpm	100 gpm	2 inch	2 inch

### Electrical Requirements

Model Designation	Part Number	Voltage (supply AC)	Phases	Frequency	Amps	GFCI Breaker
Saline C 6.0	HCSC60	120	1	60Hz	6.5	15

### Sizing Guidelines

Chlorinator sizing must comply with local codes. Please contact your local health department for specific requirements or contact your local Hayward representative for assistance.

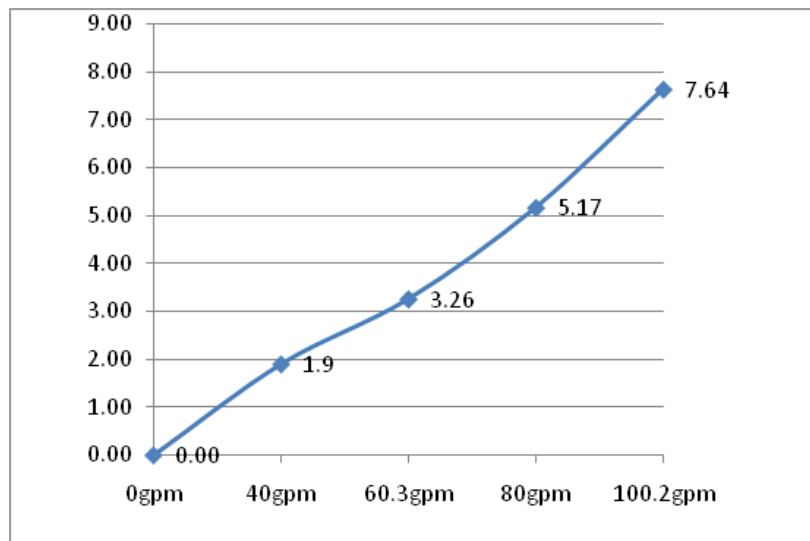

Head Loss Data  
(ft of H<sub>2</sub>O)



## INSTALLATION

### Unpacking

Units are shipped from the factory. In the event of damage during shipping, it is the responsibility of the customer to notify the carrier immediately and to file a damage claim. Open the crate or packaging carefully and examine all material inside.

### Storage

When storing units, use the original packaging and store under a shelter to protect the contents from weather.

### Plan Ahead

Almost every pump room encountered is different. It is imperative to have prior knowledge of the facility in which the unit is to be installed and to evaluate what type of tools, wall anchors, etc. will be needed to make the installation as problem free as possible.

The power supply must be installed at least 5 feet (1.5m) from the pool. It must also be mounted within 5 feet (1.5m) of the cell housing so the DC cables to the top of the electrolytic cell will reach. Also, any pool controller must be within 5 feet (1.5m) of the power supply so the control cord will reach.

The cell housing must be mounted at least 5 feet (1.5m) from the pool walls.

### Power Supply Installation

The Saline C 6.0 system comes with 4 rubber feet on the bottom of the power supply and 4 keyhole mounting holes on the back of the power supply. The power supply can sit on a shelf or similar structure without any mounting or the system can be mounted on to a wall.

**⚠ CAUTION** To reduce the risk of injury - Never try to support the weight of the power supply using only drywall anchors. The power supply must have a stud for support!

Locate a space on the wall, in the pump room, that will accommodate the dimensions of the power supply. The two top keyhole mounting holes are 11-1/4 inches apart. Install screws and hang the power supply.

### System Wiring

**⚠ WARNING** - Risk of Electric Shock. Hazardous voltage can shock, burn and cause death or serious property damage. To reduce the risk of electrical shock, turn off all power to the system.

**⚠ CAUTION** Chemical Hazard - Chemicals can cause internal and external burns, causing death, serious injury or property damage, to avoid: all systems must be wired so that when the pool circulation pump is off, the power to the Saline C 6.0 is off. Consult a Certified Electrician for the best wiring method to achieve this.

All Saline C 6.0 systems ship from the factory with a 3 foot black power cord and a 6 foot blue control cord.

Plug the power cord into a minimum 15 amp wall outlet protected by a ground fault circuit interrupter. Connect the blue control cord to a chemical feed controller **or for continuous operation without the use of a chemical feed controller**, plug the blue control cord into a 15 amp wall outlet protected by a ground fault circuit interrupter. This outlet must be interlocked with the circulation pump of the pool so that if the pump is turned off, power to the Saline C 6.0 is disconnected and the system is unable to operate.

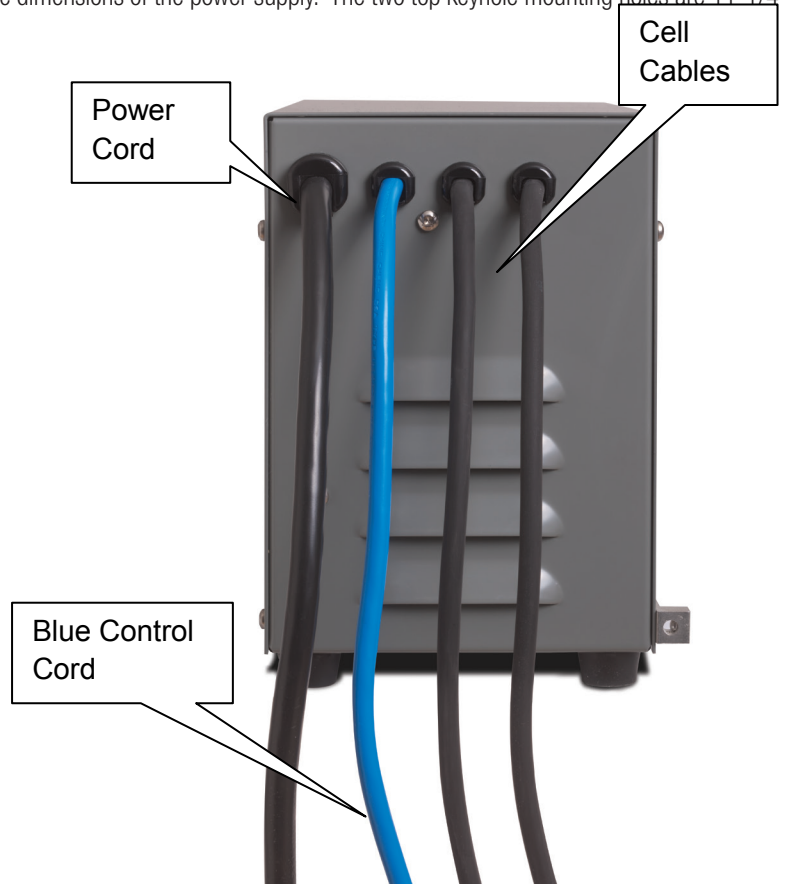

## Plumbing The System

Saline C 6.0 systems require a minimum of 40 gpm of flow through the electrolytic cell housing to achieve the rated production of chlorine. The system can be plumbed with the full flow of the circulation system flowing through the cell housing or a bypass can be created to achieve 40 gpm of flow through the cell housing. In either case the cell housing must be installed as the last component in the return to the pool, after all other equipment. The vessel has 4 mounting holes for attaching to a floor or mounting surface. See the plumbing diagrams below.

### SALINE C 6.0 System Plumbing

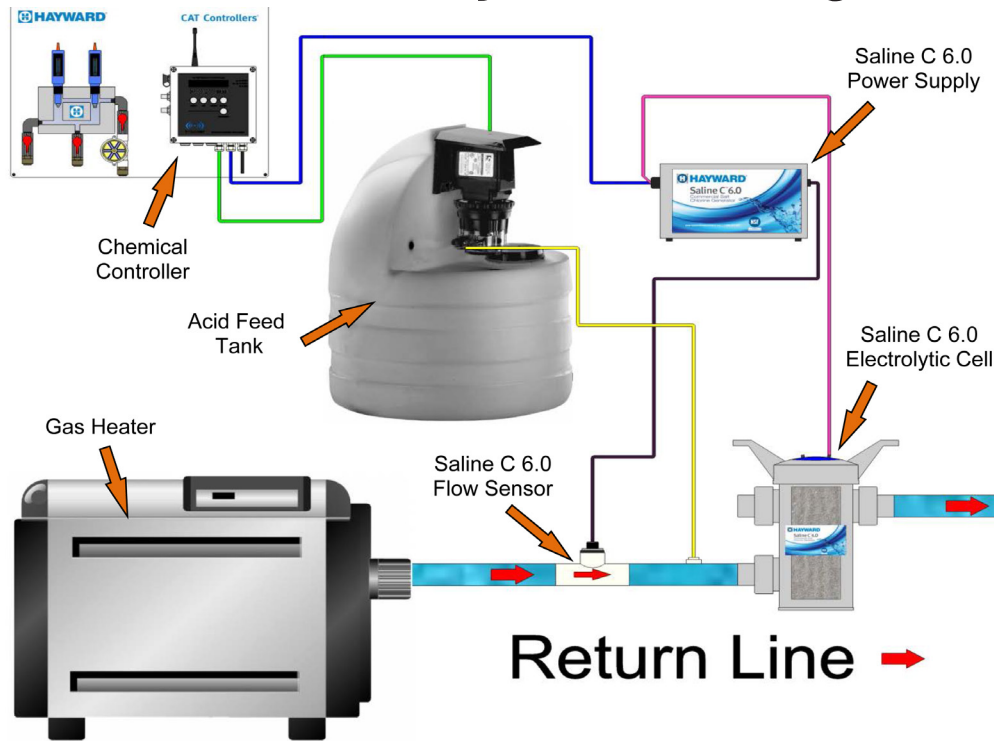

### Bypass Manifold Plumbing

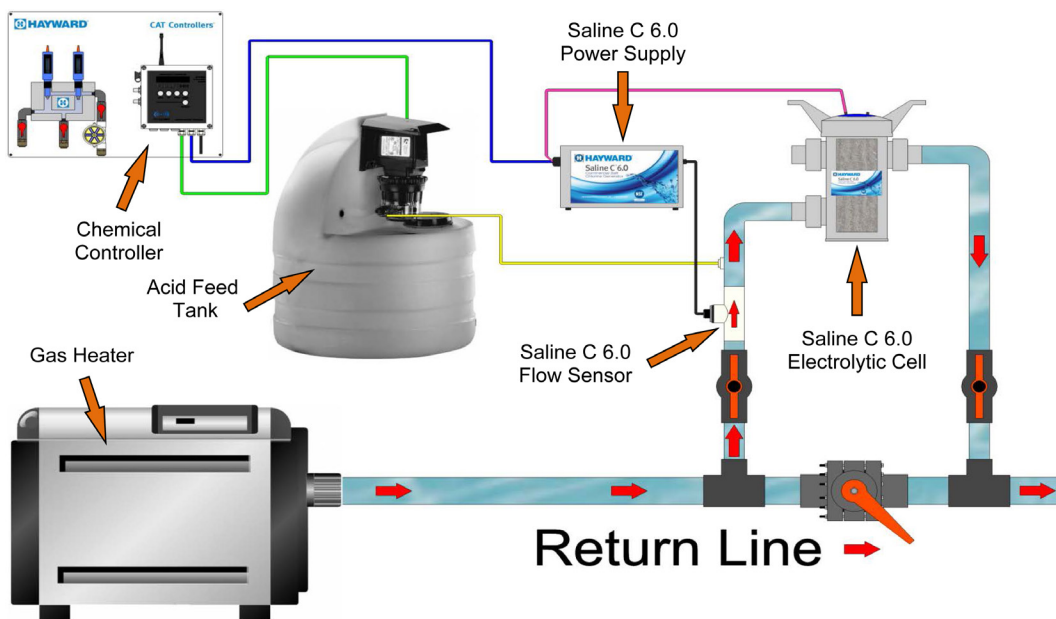



### Electrolytic Cell Housing Information

The cell housing may be installed in a “Z” configuration or in a “U” configuration. The water flow always enters at the bottom fitting (marked “Inlet”) and exits at one of the top fittings. The unused fitting is capped off with the supplied cap. The cell housing includes a slotted base for optional floor mounting. The inlet and outlet of the cell housing are 2 inch unions.

When installed correctly, the arrow on the electrode should align with the arrow on the vessel housing. This will ensure the gaps between the electrode blades are parallel to the ports allowing a clear water path between the blades.

NOTE: Do not energize or operate the unit if the cell housing is damaged or improperly assembled.



### Flow Switch Installation

The 2 inch flow switch supplied with the system must be installed on the inlet side plumbing. Installing flow switch on the outlet side plumbing may cause premature flow switch failure. See diagrams on page 5. Flow switch must be pointed in the direction of water flow (refer to arrow on the T-fitting). Plug the flow switch into the power supply at the connector shown above.

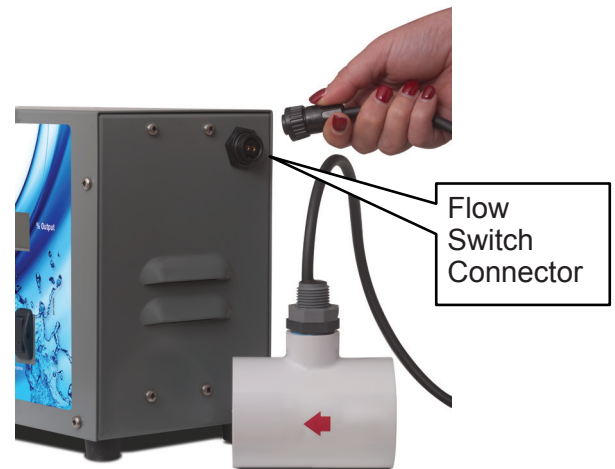

### Electrolytic Cell Wiring

Connect the cell to the power supply with the connector provided.







# OPERATION

## Preparing The Water

Hayward® saline chlorination systems operate by electrolyzing sodium chloride, NaCl, (salt that has been added to the pool) to form free chlorine. In order for the Hayward system to operate, salt must be added directly to the pool at least 24 hours before the system is started.

28 pounds of salt must be added for every 1000 gallons of pool water to reach 3500 ppm and 40 pounds of salt must be added for every 1,000 gallons of pool water to reach 5000 ppm. Once the salt has been added, brush the surface of the pool continuously until the salt has dissolved. Never leave large amounts of salt on the surface of the pool.

Only use pure NaCl. Do not use salt with additives. Contact your Hayward dealer for a list of approved salt.

Your pool water should be balanced in the following range before turning your Hayward system on:

- Chlorine:** 2 – 5 ppm
- Total Chlorine:** No more than 0.5 ppm above free chlorine
- pH:** 7.2 – 7.6
- Alkalinity:** 80 – 120
- Hardness:** 180 – 280 ppm
- Salt:** 3500 – 5000 ppm
- Cyanuric acid:** 20 – 50 ppm (Outdoor Pools only)
- Phosphates:** Less than 100 ppb
- Temperaure:** 3,500ppm salt - Minimum Temp. - 78 Degrees F  
5,000ppm salt - Minimum Temp. - 60 Degrees F  
Maximum Temp. - 104 Degrees F

## Starting The System

- Confirm that the salt concentration is 3500 to 5000 ppm.
- Confirm that the valves to and from the cell are in the open position and water is flowing through the cell tube.
- Confirm that the unit is plugged in and that the flow switch or controller relay is connected.

The system will begin producing chlorine within 3 minutes.

**Chemical Feed Controller:** If the Saline C 6.0 system is linked to a chemical feed controller, adjust the output to maximum, which will allow for full production every time the controller calls for it. **NOTE:** The Saline C 6.0 system connected to a chemical feed controller will only operate when the controller is in feed mode. Make sure that the chemical feed controller is not set in proportional mode or system damage may occur.

**Controlled Manually:** If the system is being operated manually, start at 65% output. Over the following days, monitor the pool and increase/decrease the output in small increments based on the measured chlorine level. It may take several days of to find the ideal output setting.

## System Operation

Saline C 6.0 systems operate when the main power supply cord is plugged in and the system has an input on the control connections from the flow switch and from a chemical feed controller. The Saline C 6.0 will continue to operate as long as there are inputs from those two sources.

Output is adjustable from 0 to 100% of the systems rating and is displayed as % output on the LCD display. To adjust the output, hold the output selector switch in the up position to increase output or in the down position to decrease output.

NOTE: Any time an output change is made with output selector switch, the Saline C 6.0 will record this change in its memory. In order for this to happen, the unit will wait 2 minutes from the time the change is made and shut down for 1 minute while it records the change. Output will resume after the 1 minute period.

## Low Salt Alarm

In the event that salt falls to a level too low for system operation, the system will stop generating chlorine and the LCD display will flash "LO SALT". To reset, correct the salt concentration and hold the output selector in the down position. When the fault is cleared, reset the output to the desired level.





## Maintenance

This system produces free chlorine from the salt that you have added to the water. It will only continue to operate correctly if salt is maintained at a minimum 3500 ppm level.

**NOTICE:** Low salt will lower the amount of chlorine produced, and cause damage to the electrolytic cell. The warranty will be void if the cell is damaged due to a low salt condition. Electrode life will be lengthened by keeping them clean and ensuring salt levels are at the correct level (see below).

Remember, the titanium plates that make up the cell are the most expensive part of the system and are going to need to be replaced roughly every 15,000 hours of operating time. By ensuring that salt is always at the correct level, and plates are cleaned regularly, you will increase their life.

- 1. Check salt concentration. Salt must be maintained at no less than 3500 ppm. Check salt as often as necessary to ensure at least 3500 ppm concentration. Salt concentration can be measured by using one or more of the following methods:**
  - Salt test strips. Salt test strips are accurate as long as the expiration date has not expired and the cap is always replaced immediately. Follow the directions on the bottle.
  - A variety of hand held testers could be used. Hand held testers must be calibrated regularly, follow the manufacturer's instructions.
  - Salt can be measured with a permanently mounted monitor or controller. These are typically accurate and require no calibration. A controller can be used to automatically keep the salt concentration at the desired level.
  - Adjust the salt concentration as often as needed to maintain the desired level.
- 2. Test the flow switch for proper operation at least once a month.**
- 3. Evaluate the cell condition every week. Visually inspect the cell tube for leaks and the cell stack for calcium build up.**
- 4. The vessel is equipped with a drain plug for service. To drain the vessel, follow the procedure outlined below:**
  - Disconnect power to the system
  - Close isolation valves to and from the vessel
  - Open the top of the vessel and remove the electrode stack
  - Remove the drain plug at the bottom of the vessel.
- 5. Clean the cell when it needs it. Refer to the following instructions:**

The Saline C 6.0 system is designed to operate 24 hours a day and 7 days a week at maximum production rates. Please ensure the basic maintenance and cleaning instructions are followed to guarantee performance.

**⚠ CAUTION Chemical Hazard.** Chemicals can cause burns both internally and externally. To avoid death, serious injury or property damage: Wear eye and skin protection while maintaining or servicing this unit. Do not inhale fumes from the unit.

- 
- Remove power from the system.
  - Close the isolation valves before and after the vessel.
  - Disconnect the blue connector between the power supply and vessel.
  - Remove the electrode stack by following these steps:
    - 1) Open the lid of the vessel by turning counter clockwise.
    - 2) When the lid meets resistance and stops turning, pull up on the black cables which will release the blue glamour cap.
    - 3) Once the blue glamour cap has been released, continue turning the vessel handles counter clockwise until completely loose.
    - 4) Remove the complete electrode stack assembly by pulling on the black cables.
  - In a clean plastic container, mix a 4:1 solution of water to muriatic acid (one gallon of water to one quart of muriatic acid). **ALWAYS ADD ACID TO WATER - NEVER ADD WATER TO ACID.** Be sure to wear rubber gloves and appropriate eye protection.
  - Immerse the cell stack in the solution.
  - Leave the cell in the muriatic acid mix until the solution stops bubbling and the cell is clean.
  - Rinse the unit with clear clean water.
  - Reassemble the cell stack in the tube and reconnect the cables to the top of the cell stack
  - Once finished, insert the electrode stack assembly into the vessel and reconnect the blue connector to the power supply.
  - Turn the handles of the vessel clockwise until tight, and then push down on the blue glamour cap to avoid water from entering the top of the cell.



## Winterization

In some cold climates it may be necessary to winterize the Saline C6 system. The procedure for this is as follows:

- Disconnect power to the system
- Close isolation valves to and from the vessel
- Open the top of the vessel and remove the electrode stack
- Remove the drain plug at the bottom of the vessel and drain all water
- Once all water is drained, replace the drain plug, replace the electrode stack and close the vessel lid.

Make sure no water is in the vessel if there is a possibility of freezing.

## Parts Guide

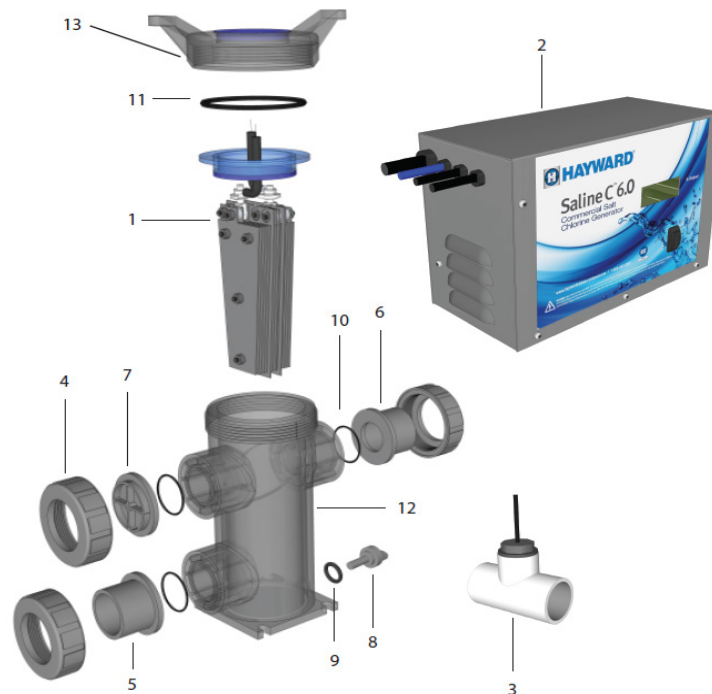

Number	Part Number	Description
1	HCXSCCELL6	Replacement Cell & Cover
2	HCXSPS6	Power Supply
3	HCXSFLOS6	Flow Sensor
4	TBX122	2" PVC True Union Ball Valve Assembly Nut
5	ECX12T	2" PVC Pipe Connector Threaded
6	ECX12S	2" PVC Pipe Connector Socket
7	BSX1CAP2	2" PVC Port Cap
8	BSX1PLUG2	1" PVC Plug
9, 10, 11	SB2KIT	O RINGS #111, #227, #357
12	BSXC201CK	2" Clear Body
13	ORX352V70	Piston Lid O-ring
NA	HCXCCCC	Replacement Cell Cbls, Connector & Grey Cap



**⚠ WARNING - Read and follow all instructions** in this owner's manual and on the equipment. Failure to follow instructions can cause severe injury and/or death.

**⚠ WARNING – Suction Entrapment Hazard.**



Suction in suction outlets and/or suction outlet covers which are, damaged, broken, cracked, missing, or unsecured can cause severe injury and/or death due to the following entrapment hazards:



**Hair Entrapment-** Hair can become entangled in suction outlet cover.



**Limb Entrapment-** A limb inserted into an opening of a suction outlet sump or suction outlet cover that is damaged, broken, cracked, missing, or not securely attached can result in a mechanical bind or swelling of the limb.



**Body Suction Entrapment-** A negative pressure applied to a large portion of the body or limbs can result in an entrapment.  
**Evisceration/ Disembowelment -** A negative pressure applied directly to the intestines through an unprotected suction outlet sump or suction outlet cover which is, damaged, broken, cracked, missing, or unsecured can result in evisceration/ disembowelment.



**Mechanical Entrapment-** There is potential for jewelry, swimsuit, hair decorations, finger, toe or knuckle to be caught in an opening of a suction outlet cover resulting in mechanical entrapment.

**⚠ WARNING - To Reduce the risk of Entrapment Hazards:**

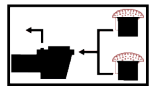

- o When outlets are small enough to be blocked by a person, a minimum of two functioning suction outlets per pump must be installed. Suction outlets in the same plane (i.e. floor or wall), must be installed a minimum of three feet (3') [1 meter] apart, as measured from near point to near point.
- o Dual suction fittings shall be placed in such locations and distances to avoid “dual blockage” by a user.
- o Dual suction fittings shall not be located on seating areas or on the backrest for such seating areas.
- o The maximum system flow rate shall not exceed the flow rating of as listed on Table 1.
- o Never use Pool or Spa if any suction outlet component is damaged, broken, cracked, missing, or not securely attached.
- o Replace damaged, broken, cracked, missing, or not securely attached suction outlet components immediately.
- o In addition two or more suction outlets per pump installed in accordance with latest ASME, APSP Standards and CPSC guidelines, follow all National, State, and Local codes applicable.
- o Installation of a vacuum release or vent system, which relieves entrapping suction, is recommended.

**⚠ WARNING – Failure to remove pressure test plugs and/or plugs used in winterization of the pool/spa from the suction outlets can result in an increase potential for suction entrapment as described above.**

**⚠ WARNING – Failure to keep suction outlet components clear of debris, such as leaves, dirt, hair, paper and other material can result in an increase potential for suction entrapment as described above.**

**⚠ WARNING – Suction outlet components have a finite life, the cover/grate should be inspected frequently and replaced at least every ten years or if found to be damaged, broken, cracked, missing, or not securely attached.**

**⚠ CAUTION – Components such as the filtration system, pumps and heater must be positioned so as to prevent their being used as means of access to the pool by young children. To reduce risk of injury, do not permit children to use or climb on this product. Closely supervise children at all times. Components such as the filtration system, pumps, and heaters must be positioned to prevent children from using them as a means of access to the pool.**



**⚠ WARNING – Hazardous Pressure.** Pool and spa water circulation systems operate under hazardous pressure during start up, normal operation, and after pump shut off. Stand clear of circulation system equipment during pump start up. Failure to follow safety and operation instructions could result in violent separation of the pump housing and cover, and/or filter housing and clamp due to pressure in the system, which could cause property damage, severe personal injury, or death. Before servicing pool and spa water circulation system, all system and pump controls must be in off position and filter manual air relief valve must be in open position. Before starting system pump, all system valves must be set in a position to allow system water to return back to the pool. Do not change filter control valve position while system pump is running. Before starting system pump, fully open filter manual air relief valve. Do not close filter manual air relief valve until a steady stream of water (not air or air and water) is discharged.



**⚠ WARNING – Separation Hazard.** Failure to follow safety and operation instructions could result in violent separation of pump and/or filter components. Strainer cover must be properly secured to pump housing with strainer cover lock ring. Before servicing pool and spa circulation system, filters manual air relief valve must be in open position. Do not operate pool and spa circulation system if a system component is not assembled properly, damaged, or missing. Do not operate pool and spa circulation system unless filter manual air relief valve body is in locked position in filter upper body. **Never operate or test the circulation system at more than 50 PSI.**



**⚠ WARNING – Risk of Electric Shock.** All electrical wiring **MUST** be in conformance with applicable local codes, regulations, and the National Electric Code (NEC). Hazardous voltage can shock, burn, and cause death or serious property damage. To reduce the risk of electric shock, do **NOT** use an extension cord to connect unit to electric supply. Provide a properly located electrical receptacle. Before working on any electrical equipment, turn off power supply to the equipment. To reduce the risk of electric shock replace damaged wiring immediately. Locate conduit to prevent abuse from lawn mowers, hedge trimmers and other equipment. Do **NOT** ground to a gas supply line.

**⚠ WARNING – Risk of Electric Shock** Failure to ground all electrical equipment can cause serious or fatal electrical shock hazard. Electrical ground all electrical equipment before connecting to electrical power supply.

**⚠ WARNING – Risk of Electric Shock** Failure to bond all electrical equipment to pool structure will increase risk for electrocution and could result in injury or death. To reduce the risk of electric shock, see installation instructions and consult a professional electrician on how to bond all electrical equipment. Also, contact a licensed electrician for information on local electrical codes for bonding requirements.

**Notes to electrician:** Use a solid copper conductor, size 8 or larger. Run a continuous wire from external bonding lug to reinforcing rod or mesh. Connect a No. 8 AWG (8.4 mm<sup>2</sup>) [No. 6 AWG (13.3 mm<sup>2</sup>) for Canada] solid copper bonding wire to the pressure wire connector provided on the electrical equipment and to all metal parts of swimming pool, spa, or hot tub, and metal piping (except gas piping), and conduit within 5 ft. (1.5 m) of inside walls of swimming pool, spa, or hot tub.

**IMPORTANT** - Reference NEC codes for all wiring standards including, but not limited to, grounding, bonding and other general wiring procedures.

**⚠ WARNING – Risk of Electric Shock .** The electrical equipment must be connected only to a supply circuit that is protected by a ground-fault circuit-interrupter (GFCI). Such a GFCI should be provided by the installer and should be tested on a routine basis. To test the GFCI, push the test button. The GFCI should interrupt power. Push reset button. Power should be restored. If the GFCI fails to operate in this manner, the GFCI is defective. If the GFCI interrupts power to the electrical equipment without the test button being pushed, a ground current is flowing, indicating the possibility of an electrical shock. Do not use this electrical equipment. Disconnect the electrical equipment and have the problem corrected by a qualified service representative before using.

**⚠ CAUTION – HAYWARD® pumps** are intended for use with permanently-installed pools and may be used with hot tubs and spas if so marked. Do not use with storable pools. A permanently-installed pool is constructed in or on the ground or in a building such that it cannot be readily disassembled for storage. A storable pool is constructed so that it is capable of being readily disassembled for storage and reassembled to its original integrity.

## SAVE THESE INSTRUCTIONS

To original purchasers of this equipment, Hayward Industries, Inc. warrants its Salt Chlorine Generator HCSC60 to be free from defects in materials and workmanship for a period of Two (2) years from the date of purchase with the following exception. The electrodes carry a One (1) year full warranty and a prorated warranty for the second year.

The limited warranty excludes damage from freezing, negligence, improper installation, improper use or care or any Acts of God. Parts that fail or become defective during the warranty period shall be repaired or replaced, at our option, within 90 days of the receipt of defective product, barring unforeseen delays, without charge.

Proof of purchase is required for warranty service. In the event proof of purchase is not available, the manufacturing date of the product will be the sole determination of the purchase date.

To obtain warranty service, please contact the place of purchase or the nearest Hayward Authorized Service Center. For assistance on your nearest Hayward Authorized Service Center please visit us at [www.haywardpool.com](http://www.haywardpool.com).

Hayward shall not be responsible for cartage, removal, repair or installation labor or any other such costs incurred in obtaining warranty replacements or repair.

The Hayward Pool products warranty does not apply to components manufactured by others. For such products, the warranty established by the respective manufacturer will apply.

The express limited warranty above constitutes the entire warranty of Hayward Pool Products with respect to its pool products and is in lieu of all other warranties expressed or implied, including warranties of merchantability or fitness for a particular purpose. In no event shall Hayward Pool products be responsible for any consequential, special or incidental damages of any nature.

Some states do not allow a limitation on how long an implied warranty lasts, or the exclusion of incidental or consequential damages, so the above limitation may not apply to you. This warranty gives you specific legal rights, and you may also have other rights, which vary from state to state.

Hayward Pool Products  
620 Division Street  
Elizabeth, NJ 07207

\*Supersedes all previous publications.

