

DT-902 MANUAL











Introduction

The Motor and Phase Rotation indicator is a handheld, battery-operated instrument designed to detect the rotary field of three-phase systems and determine motor-rotation direction.

Symbols

The following symbols appear on the Motor and Phase Rotation indicator or in this manual.

Table 1. Symbols

	Risk of electric shock		Earth
	Risk of Danger . Important information See manual		AC or DC
	Hazardous Voltage.		Conforms to EU directives.
	Equipment protected by double or reinforced Insulation	CAT III	OVERVOLTAGE(Installation) CATEGORY III,Pollution Degree 2 per IEC 1010-1 refers to the level of Impulse Withstand Voltage protection provided.Equipment of OVERVOLTAGE CATEGORY III is equipment in fixed installations (e.g.,electricity meter and primary over-current protection equipment.)
	Battery		Recycling information

Elements of the Motor and Phase Rotation indicator

Indicators, buttons, and jacks are shown in Figure 1.

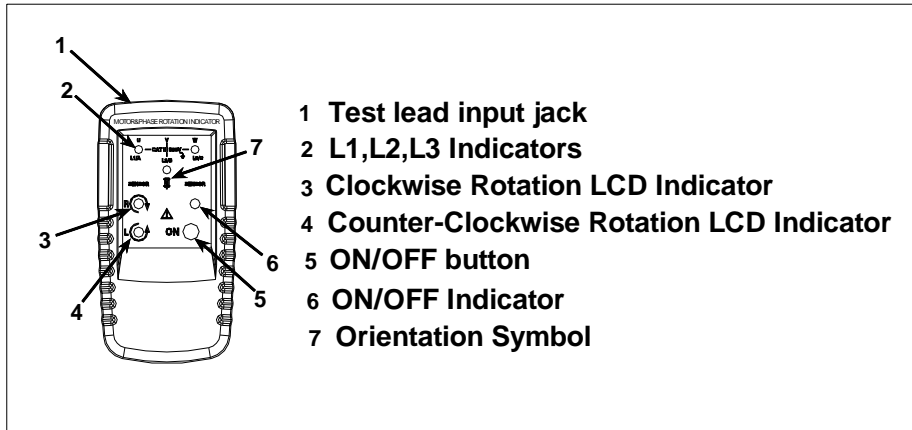

Figure 1. The Motor and phase Rotation Indicator

Using the Motor & phase Rotation Indicator

Determine Rotary Field Direction

To determine the rotary field direction:

- Connect one end of the test leads to the Motor and Phase Rotation indicator. Make sure the L1, L2, and L3 test leads are connected to the corresponding input jacks.
- Connect the test probes to the other end of the test leads.
- Connect the test probes to the three mains phases. Press the ON/OFF button. The green ON indicator shows that the instrument is ready for testing.
- Either the Clockwise or Counter Clockwise Rotary indicator illuminates showing the Type of rotary field direction present.
- The rotary indicator lights even if the neutral conductor, N, is connected instead of the Test lead input jacks. Refer to Figure 2 (also shown on the back of the Motor and Phase Rotation indicator) for more information.

		○ OFF	● NOT DEFINED			
		⊗ ON				
		L1=A,L2=B,L3=C				
DISPLAY		L1	L2	L3		
⊗ CORRECT	⊗	⊗	⊗	⊗	⊗	
⊗ FALSE	⊗	⊗	⊗	⊗	⊗	
L1 MISSING	⊗	⊗	⊗	⊗	⊗	
L2 MISSING	⊗	⊗	⊗	⊗	⊗	
L3 MISSING	⊗	⊗	⊗	⊗	⊗	

Figure 2. Phase Indication Table (shown on

the rear of the Motor and Phase Rotation indicator)

Non-contact Rotary Field Indication

For non-contact rotary field indication:

- Disconnect all test leads from the Motor and Phase Rotation indicator.
- Position the Indicator on the motor so that it is parallel to the length of the motor shaft. The Indicator should be one inch or close to the motor. See Figure 3.
- Press the ON/OFF button. The green ON indicator shows that the instrument is ready for testing.
- Either the Clockwise or Counter Clockwise Rotary indicator illuminates showing the type of rotary field direction present.

Note

The indicator will not operate with engines controlled by frequency converters. The bottom of the Motor and Phase Rotation indicator should be oriented towards the drive shaft. See the Orientation Symbol on the Motor and Phase Rotation indicator.

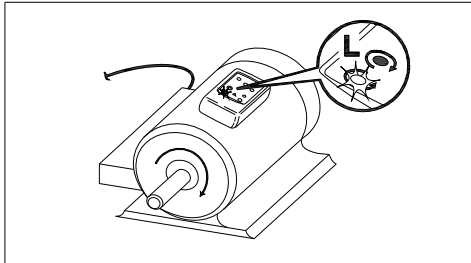

Figure 3. Motor Rotation

See Table 2 for the minimum motor diameter and number of pole pair to obtain a reliable test result.

Table 2. Reliable Motor Test Requirements

Number of pole pair	Rotary Number Of Rotary Field (1/min) at Frequency (HZ)			Angel Between poles	Min. \varnothing of Motorcase
	16 2/3	50	60		
1	1000	3000	3600	60	5.3
2	500	1500	1800	30	10.7
3	333	1000	1200	20	16.0
4	250	750	900	15	21.4
5	200	600	720	12	26.7
6	167	500	600	10	32.1
8	125	375	450	7.5	42.8
10	100	300	360	6	53.5
12	83	250	300	5	64.2
16	62	188	225	3.75	85.6

Determine the Motor Connection

- Connect one end of the test leads to the Motor and Phase Rotation indicator. Make sure the L1, L2, and L3 test leads are connected to the corresponding jack.
- Connect the alligator clamps to the other end of the test leads.
- Connect the alligator clamps to the motor connections, L1 to U, L2 to V, L3 to W.
- Press the ON/OFF button. The green ON indicator shows that the instrument is ready for testing.
- Turn the motor shaft half a revolution towards the right.

Note

The bottom of the Motor and Phase Rotation indicator should be oriented towards the drive shaft. See the Orientation Symbol on the Motor and Phase Rotation indicator. Either the Clockwise or Counter Clockwise Rotary indicator illuminates showing the type of rotary field direction present.

Magnetic Field Detection

To detect a magnetic field, place the Motor and Phase Rotation indicator to a solenoid valve.

A magnetic field is present if either the Clockwise or the Counter Clockwise Rotary indicator illuminate.

Note

The Motor and Phase Rotation indicator contains alkaline batteries. Do not dispose of these batteries with other solid waste. Used batteries should be disposed of by a qualified recycler or hazardous materials handler.

The Motor and Phase Rotation indicator uses a 9V battery (supplied). To replace the battery, follow these steps.



1. Place the Motor and Phase Rotation indicator face down on a nonabrasive surface and loosen the battery-door screw with a screwdriver.
2. Lift the battery access lid away from the Motor and Phase Rotation indicator.
3. Observe the battery polarity shown in the battery compartment.
4. Secure the battery access lid back in position with the screw.

Unpacking the Motor and Phase Rotation indicator

The Motor and Phase Rotation indicator ships with the following items:

3 test leads
3 test probes
3 alligator clips
9 V battery
Users Manual

Safety Information

-  **Caution identifies conditions and actions that may damage the DT-902**
-   **Warning identifies conditions and actions that pose hazard to the user.**

Read First: Safety Information

To avoid possible electric shock or fire, do the following:

- Read the following safety information carefully before using or servicing the instrument. Adhere to local and national safety codes.
- Individual protective equipment must be used to prevent shock and injury.
- Use of instrument in a manner not specified by the manufacturer may impair safety features/protection provided by the equipment.
- Avoid working alone. Damage leads must be replaced. Do not use the Motor and Phase Rotation indicator if it looks damaged.
- Be careful when working above 30V ac rms, 42V ac peak and 60V dc. Such voltages pose a shock hazard.
- When using the probes, keep fingers away from probe contacts. Keep fingers behind the finger guards on the probes.
- Measurements can be adversely affected by impedances of additional operating circuit connected in parallel or by transient currents.
- Verify operation prior to measuring hazardous voltages (voltages above 30V ac rms, 42V ac peak and 60V dc).
 - Do not use the Motor and Phase Rotation indicator with any of the parts removed.
 - Do not use the Motor and Phase Rotation indicator around explosive gas, vapor, or dust.
 - Do not use the Motor and Phase Rotation indicator in a wet environment. cuits

Specifications

General specifications

Environmental Operating Temperature:	0°C to +40°C
Operating Altitude:	2000 m
Pollution Degree:	2
Type of protection:	IP 40

Mechanical Specifications

Size (H x W x D):	130mm x 69mm x 32mm.
Weight:	130g
Humidity:	15% to 80%

Safety Specifications

Electrical Safety Meets:	DIN VDE 0411, IEC 61010 DIN, VDE 0413-7, IEC 61557-7/EN 61557-7
Maximum Operating Voltage (U _{me}):	400 V AC for all ranges
Protection Levels:	CAT III, 300V

Electrical Specifications

Battery:	9 V alkaline, IEC 6LR61
Current Consumption:	Max 20 mA
Battery life:	Minimum 1 year for average use
Determine Rotary Field Direction	
Nominal Voltage Rotary Direction:	1 to 400 V AC
Nominal Voltage phase indirection:	120 to 400 V AC
Frequency Range (fn):	2 to 400HZ
Inspect the test leads for damaged insulation or exposed metal. Check test lead continuity.	
Test Currents (I _n per phase):	Less than 3.5 m A
Non-Contact Rotary Field Indication	
Frequency Range (fn):	2 to 400HZ
Determine the Motor Connection	
Nominal Test Voltage (U _{me}):	1 to 400 V AC
Nominal Test Currents (I _n per phase):	Less than 3.5 m A
Frequency Range (fn):	2 to 400 HZ