



T-J305 6V 330Ah

Sealed Lead-Acid (SLA) Deep Cycle Gel Battery

Applications

- EV Golf Cart, Utility Vehicles or NEV
- Scissor Lifts, Aerial Work Platforms
- Floor Sweeper, Scrubbers or Floor Cleaning Machine
- Material Handling
- Renewable Energy System

General Features

- DOD 50% more than 1500 life cycles @ 25°C
- Long life and high stability under high temperature environment
- Design for usable at tropical countries
- Rechargeable and maintenance-free
- Gel VRLA (Valved Regulated Lead-Acid) battery

Specifications

BCI Group Size	Model	Voltage	Cell	1 Capacity (Ah) @ 25°C						2 Minutes of Discharge			Internal Resistance	Dimensions (mm)				Weight (kg)
				1 hr rate	2 hr rate	5 hr rate	10 hr rate	20 hr rate	100 hr rate	@25A	@56A	@75A		L	W	H	TH	
902	T-J305	6V	3	173	220	262	309	330	374	700	278	192	≤ 1.6mΩ	295	178	354	360	46.8

¹ The amount of amp-hours (Ah) a battery can deliver when discharged at a constant rate a 25°C and maintain a voltage above 1.75V/cell. Capacities are based on peak performance.

² The number of minutes a battery can deliver when discharged at a constant rate at 25°C and maintain a voltage above 1.75 V/cell. Capacities are based on peak performance.

Charging Instructions

Recommended Charge Current

- With Temperature Compensation
- Without Temperature Compensation

Charge Voltage (6 Volts)

Bulk Charge

Absorption Charge

Float Charge

Temperature Compensate Factor

Cyclic Application

59.4 A Max.

33.0 - 59.4 A

7.2 - 7.45 V

7.35 V

7.35 V

6.85 V

- 4 mV/°C/Cell

Operating Temperature

Discharge: -15°C~45°C

Charge: -15°C~45°C

Storage: -15°C~45°C

DO NOT charge at temperature corrected voltages above 7.5 Volts (2.5 Volts/cell).

Use of voltage controlled charger is a requirement for warranty coverage.

For best cycle life, limit discharge to less than 50% of the battery's 20 hour capacity.

Dimensions and Terminal

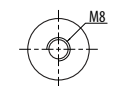
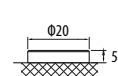
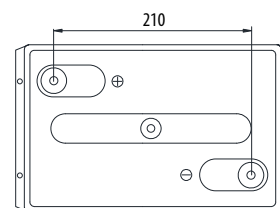
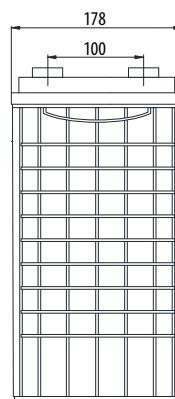
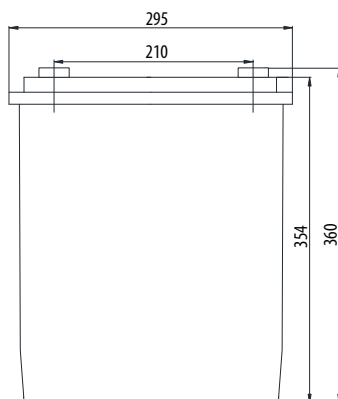

Terminal: M8

Unit: mm

T-J305 6V 330Ah

Sealed Lead-Acid (SLA) Deep Cycle Gel Battery



Battery Construction

Positive plate	Negative plate	Container&Cover	Safety valve	Terminal	Seperator	Electrolyte	Pillar seal
Thick high Sn, low Ca grid	Pb-Ca grid	ABS	Si-Rubber	Copper insert M8	PVC/AGM seperator for high pressure cell	Silica Gel	Two layers epoxy resin seal

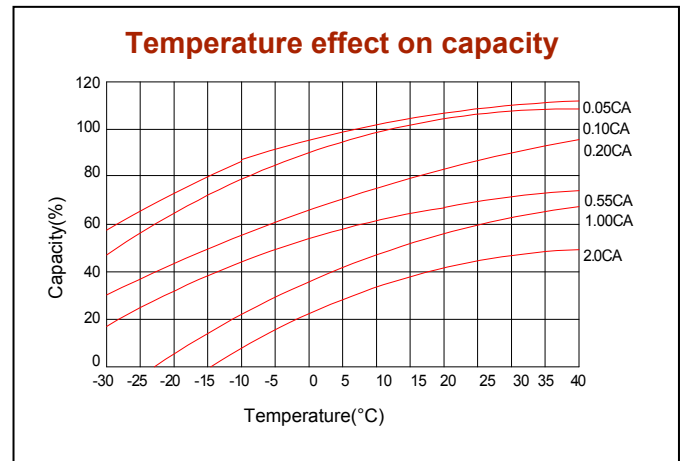
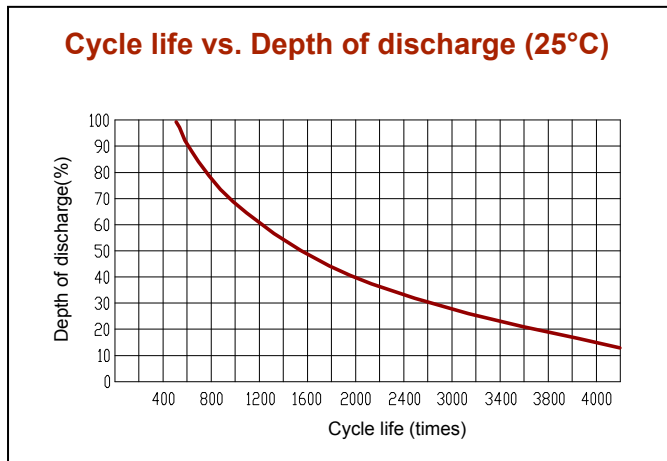
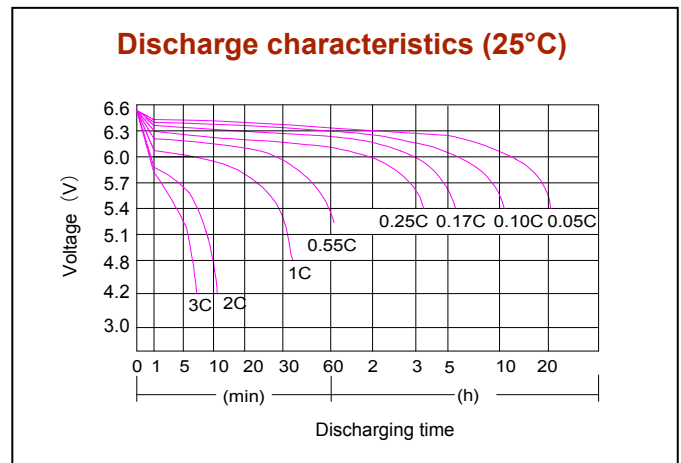
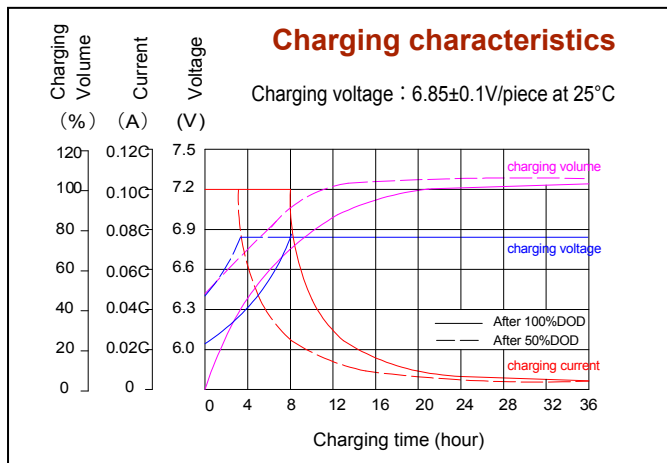

DENA ENGINEERING CO.,LTD.

185/1 Wongsawang Road, Wongsawang, Bangsue, Bangkok 10800 THAILAND

Tel. 02-587-7780, 02-910-9600 e-mail: dena@dena.co.th www.dena.co.th