

DS-2CD3726G2T-IZS

AcuSense 2 MP Varifocal Dome Network Camera

AcuSense

Powered by

DarkFighter



Empowered by deep learning algorithms, Hikvision AcuSense technology brings human and vehicle targets classification alarms to front- and back-end devices. The system focuses on human and vehicle targets, vastly improving alarm efficiency and effectiveness.

- High quality imaging with 2 MP resolution
- Excellent low-light performance with powered-by-DarkFighter technology
- Clear imaging against strong back light due to 120 dB true WDR technology
- Efficient H.265+ compression technology
- False alarm reduction through human and vehicle target classification based on deep learning
- Water and dust resistant (IP67) and vandal-resistant (IK10)
- 3D DNR technology delivers clean and sharp images
- Motorized varifocal lens for easy installation and monitoring

CDG | Computer Peripheral and Supplies Ltd.

Computer Peripheral and Supplies Ltd.

244 Soi Pattanakam 53, Pattanakam, Suanluang, Bangkok 10250 Thailand

Contact Us

Tel : (66) 0-2322-9535, 0-2722-4040

Fax : (66) 0-2322-7990

E-Mail : sales.dept@cps.co.th

Web site : www.cps.co.th, www.facebook.com/cps.co.th

More Details

Scan Here

[LINE ID](#)

Need more

Information



▪ Specification

Camera	
Image Sensor	1/2.8" Progressive Scan CMOS
Min. Illumination	Color: 0.002 Lux @ (F1.4, AGC ON), B/W: 0 Lux with IR
Shutter Speed	1/3 s to 1/100,000 s
Slow Shutter	Yes
P/N	P/N
Wide Dynamic Range	120 dB
Day & Night	IR cut filter
Power-off Memory	Yes
Angle Adjustment	Pan: 0° to 355°, tilt: 0° to 75°, rotate: 0° to 355°
Lens	
Lens Type	Varifocal lens, motor-driven lens, 2.7 to 13.5 mm and 7 to 35 mm optional
Iris Type	Auto-iris
Lens Mount	2.7 to 13.5 mm: Ø14 7 to 35 mm: Integrated
Focal Length & FOV	2.7 to 13.5 mm: horizontal FOV 113° to 34°, vertical FOV 58° to 19°, diagonal FOV 138° to 39° 7 to 35 mm: horizontal FOV 30° to 11°, vertical FOV 17° to 6°, diagonal FOV 34° to 13°
Aperture	2.7 to 13.5 mm: F1.4 7 to 35 mm: F1.6
DORI	
DORI	2.7 to 13.5 mm: D: 44 to 129 m, O: 17 to 51 m, R: 8 to 25 m, I: 4 to 13 m 7 to 35 mm: D: 137 to 400 m, O: 54 to 158 m, R: 27 to 80 m, I: 13 to 40 m
Illuminator	
Supplement Light Type	IR
IR Range	2.7 to 13.5 mm: up to 40 m 7 to 35 mm: up to 50 m
IR Wavelength	850 nm
Smart Supplement Light	Yes
Video	
Max. Resolution	1920 × 1080
Main Stream	50 Hz: up to 50 fps (1920 × 1080, 1280 × 720) 60 Hz: up to 60 fps (1920 × 1080, 1280 × 720) *High frame rate is supported under certain settings.
Sub-Stream	50 Hz: 25 fps (640 × 480, 640 × 360) 60 Hz: 30 fps (640 × 480, 640 × 360)
Third Stream	50 Hz: 10 fps (1920 × 1080, 1280 × 720, 640 × 480, 640 × 360) 60 Hz: 10 fps (1920 × 1080, 1280 × 720, 640 × 480, 640 × 360) *Third stream is supported under certain settings.
Fourth Stream	50 Hz: 10 fps (1280 × 720, 640 × 480, 640 × 360) 60 Hz: 10 fps (1280 × 720, 640 × 480, 640 × 360) *Fourth stream is supported under certain settings.

Video Compression	Main stream: H.265/H.264/H.264+/H.265+ Sub-stream: H.265/H.264/MJPEG Third stream: H.265/H.264 Fourth stream: H.265/H.264/MJPEG *Third stream and fourth stream are supported under certain settings.
Video Bit Rate	32 Kbps to 8 Mbps
H.264 Type	Baseline Profile/Main Profile/High Profile
H.265 Type	Main Profile
H.264+	Main stream supports
H.265+	Main stream supports
Bit Rate Control	CBR/VBR
Scalable Video Coding (SVC)	H.264 and H.265 encoding
Region of Interest (ROI)	5 fixed regions for main stream and sub-stream
Audio	
Environment Noise Filtering	Yes
Audio Sampling Rate	8 kHz/16 kHz/32 kHz/44.1 kHz/48 kHz
Audio Compression	G.711ulaw/G.711alaw/G.722.1/G.726/MP2L2/PCM/MP3/AAC-LC
Audio Bit Rate	64 Kbps (G.711ulaw/G.711alaw)/16 Kbps (G.722.1)/16 Kbps (G.726)/32 to 192 Kbps (MP2L2)/8 to 320 Kbps (MP3)/16 to 64 Kbps (AAC-LC)
Network	
Simultaneous Live View	Up to 6 channels
API	Open Network Video Interface (PROFILE S, PROFILE G, PROFILE T), ISAPI, SDK, ISUP
Protocols	TCP/IP, ICMP, HTTP, HTTPS, FTP, DHCP, DNS, DDNS, RTP, RTSP, NTP, UPnP, SMTP, IGMP, 802.1X, QoS, IPv4, IPv6, UDP, Bonjour, SSL/TLS, PPPoE, ARP, SNMP, WebSocket, WebSockets
User/Host	Up to 32 users. 3 user levels: administrator, operator and user
Security	Password protection, complicated password, HTTPS encryption, IP address filter, Security Audit Log, basic and digest authentication for HTTP/HTTPS, TLS 1.1/1.2, WSSE and digest authentication for Open Network Video Interface
Network Storage	MicroSD/SDHC/SDXC card (512 GB) local storage, and NAS (NFS, SMB/CIFS), auto network replenishment (ANR) Together with high-end Hikvision memory card, memory card encryption and health detection are supported.
Client	iVMS-4200, Hik-Connect, Hik-Central
Web Browser	Plug-in required live view: IE 10, IE 11, Plug-in free live view: Chrome 57.0+, Firefox 52.0+, Edge 89+, Local service: Chrome 57.0+, Firefox 52.0+, Edge 89+
Image	
SNR	≥ 52 dB
Day/Night Switch	Day, Night, Auto, Schedule
Target Cropping	Yes
Image Enhancement	BLC, HLC, 3D DNR
Image Parameters Switch	Yes
Image Settings	Rotate mode, saturation, brightness, contrast, sharpness, gain, white balance adjustable by client software or web browser

Interface	
Alarm	2 inputs, 2 outputs (max. 24 VDC/24 VAC, 1 A)
Audio	1 input (line in), max input amplitude: 3.3 vpp, input impedance: 4.7 K Ω , interface type: non-equilibrium; 1 output (line out), max output amplitude: 3.3 vpp, output impedance: 100 Ω , interface type: non-equilibrium
On-Board Storage	Built-in micro SD/SDHC/SDXC slot, up to 512 GB
Hardware Reset	Yes
Ethernet Interface	1 RJ45 10 M/100 M self-adaptive Ethernet port
Power Output	12 VDC, max. 100 mA
Event	
Basic Event	Motion detection (human and vehicle targets classification), video tampering alarm, exception
Smart Event	Unattended baggage detection, object removal detection, scene change detection, audio exception detection
Deep Learning Function	
Face Capture	Yes
Perimeter Protection	Line crossing detection, intrusion detection, region entrance detection, region exiting detection
General	
Linkage Method	Upload to NAS/memory card/FTP, notify surveillance center, trigger recording, trigger capture, send email, audible warning
Firmware Version	V5.5.112
Web Client Language	33 languages English, Russian, Estonian, Bulgarian, Hungarian, Greek, German, Italian, Czech, Slovak, French, Polish, Dutch, Portuguese, Spanish, Romanian, Danish, Swedish, Norwegian, Finnish, Croatian, Slovenian, Serbian, Turkish, Korean, Traditional Chinese, Thai, Vietnamese, Japanese, Latvian, Lithuanian, Portuguese (Brazil), Ukrainian
General Function	Anti-flicker, heartbeat, mirror, privacy mask, flash log, password reset via email, pixel counter
Software Reset	Yes
Storage Conditions	-30 °C to 60 °C (-22 °F to 140 °F). Humidity 95% or less (non-condensing)
Startup and Operating Conditions	-30 °C to 60 °C (-22 °F to 140 °F). Humidity 95% or less (non-condensing)
Power Supply	12 VDC \pm 25% PoE: 802.3af, class 3
Power Consumption and Current	12 VDC, 0.9 A, max. 10.8 W PoE (802.3af, 36 V to 57 V), 0.36 A to 0.23 A, max. 12.9 W
Power Interface	\varnothing 5.5 mm coaxial power plug
Camera Material	Metal
Camera Dimension	\varnothing 153.3 mm \times 111.6 mm (\varnothing 6.0" \times 4.4")
Package Dimension	261 mm \times 217 mm \times 197 mm (10.3" \times 8.5" \times 7.8")
Camera Weight	Approx. 895 g (1.9 lb.)
With Package Weight	Approx. 1930 g (3.2 lb.)

Approval

EMC	FCC SDoC (47 CFR Part 15, Subpart B); CE-EMC (EN 55032: 2015, EN 61000-3-2: 2014, EN 61000-3-3: 2013, EN 50130-4: 2011 +A1: 2014); RCM (AS/NZS CISPR 32: 2015); IC VoC (ICES-003: Issue 6, 2016); KC (KN 32: 2015, KN 35: 2015)
Safety	UL (UL 60950-1); CB (IEC 60950-1:2005 + Am 1:2009 + Am 2:2013, IEC 62368-1:2014); CE-LVD (EN 60950-1:2005 + Am 1:2009 + Am 2:2013, IEC 62368-1:2014); BIS (IS 13252(Part 1):2010+A1:2013+A2:2015); LOA (IEC/EN 60950-1)
Environment	CE-RoHS (2011/65/EU); WEEE (2012/19/EU); Reach (Regulation (EC) No 1907/2006)
Protection	IP67 (IEC 60529-2013), IK10 (IEC 62262:2002)

Available Model

DS-2CD3726G2T-IZS (2.7 to 13.5 mm, 7 to 35 mm)

Typical Application

Hikvision products are classified into three levels according to their anti-corrosion performance. Refer to the following description to choose for your using environment.

This model has NO SPECIFIC PROTECTION.

Level	Description
Top-level protection	Hikvision products at this level are equipped for use in areas where professional anti-corrosion protection is a must. Typical application scenarios include coastlines, docks, chemical plants, and more.
Moderate protection	Hikvision products at this level are equipped for use in areas with moderate anti-corrosion demands. Typical application scenarios include coastal areas about 2 kilometers (1.24 miles) away from coastlines, as well as areas affected by acid rain.
No specific protection	Hikvision products at this level are equipped for use in areas where no specific anti-corrosion protection is needed.

Dimension

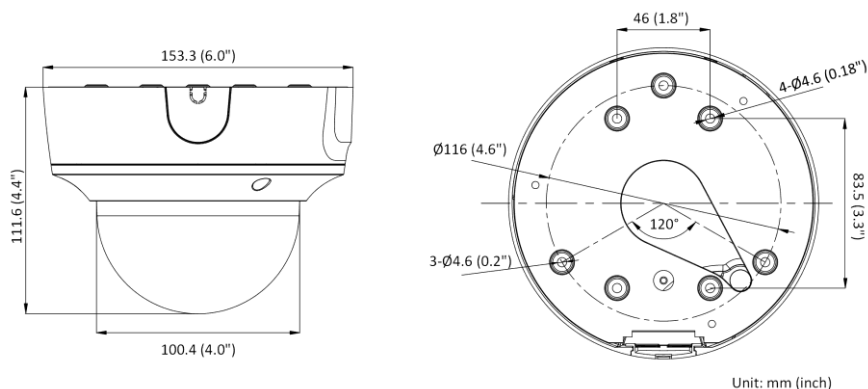

▪ **Accessory**



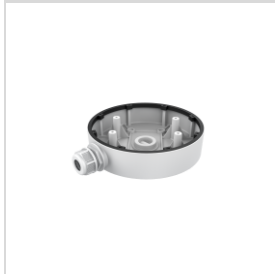

▪ **Included**

DS-1280ZJ-DM55

Junction Box



▪ **Optional**

<p>DS-1473ZJ-155 Wall Mount</p>	<p>DS-1253ZJ-L Rain Shade</p>	<p>DS-1473ZJ-155B Wall Mount</p>	<p>DS-1471ZJ-155 Pendant Mount</p>	<p>DS-1250ZJ Rain Shade</p>
				
<p>DS-1475ZJ-SUS Vertical Pole Mount</p>	<p>DS-1227ZJ-DM44 Pendant Mount</p>	<p>DS-1476ZJ-SUS Corner Mount</p>		
