

# INSTALLATION MANUAL

## TIS DUCTED AC GATEWAY











Model: TIS-GTY-1AC



### **i** PRODUCT INFORMATION

This gateway is used to control many ducted AC brands that use digital remote control, it can make the connection to control multiple fan speeds, (low/medium/high) cooling, and heating.

#### PRODUCT SPECIFICATIONS

 <b>Outputs Voltage</b>	External outputs power consumption	DC7~15V0.7W(MAX) 0.5W
 <b>TIS Bus</b>	Number of devices on 1 line Bus voltage Current consumption (Normal) Current consumption (Peak) Protection	Max. 64 12-32 V DC <20 mA / 24 V DC <100 mA / 24 V DC Reverse polarity protection
 <b>Reaction time</b>		Approx. 20ms
 <b>Function</b>	Cool, Heat, FAN Fan speed control	Cool, Heat, FAN Control Low, Medium, High linked outputs
 <b>Mounting</b>	Wall mount Table top	Screw holder on the back of the module Free locate
 <b>Connection terminal</b>		Screw terminal 0,1...2mm
 <b>Weight</b>	Without packaging	0.15 KG
 <b>Dimensions</b>	Width x Length x Height	85mm x 85mm x 28mm
 <b>Housing</b>	Materials IP rating	ABS White IP 20
 <b>Temperature range</b>	Operation Storage Transport	-30...65°C -20...65°C -30...75°C
 <b>Air humidity</b>		<90% non-condensing



BARCODE (UPC-A)





### READ INSTRUCTIONS

We recommend that you read this Instruction Manual before installation.



### SAFETY INSTRUCTIONS

Electrical equipment should only be installed and fitted by electrically skilled persons.

Failure to observe the instructions may cause damage to the device and other hazards. These instructions are an integral part of the product and must remain with the end customer.

Any issues stemming from an installation by an unauthorised person is the responsibility of the user and will not be covered by warranty.



### PROGRAMMING

This device can be tested and programmed manually. Advanced programming requires knowledge of the TIS Device Search software and instruction in the TIS advanced training courses.



### SIMPLE INSTALLATION

You can install this module on a wall or place it on a stable surface.



### MOUNTING LOCATION

Position the device on a stable location with easy access to wiring and terminals.



### WARRANTY

There is a Two-Year warranty provided by law. The hologram warranty seal and product serial number are available on each device.





## PRODUCT INTRODUCTION

- ▶ This device supports air-conditioning systems and panels of Daikin, Hitachi, Gree, Mitsubishi Heavy Industries, Midea, Hisense, Toshiba, York, Haier, Fujitsu and other brands.
- ▶ TIS-BUS Protocol
- ▶ Built-in Bluetooth upgrade function, high adaptability on site, providing a variety of remote upgrade solutions.
- ▶ It can be connected to the air conditioner alone and connected to a third-party panel for use, or it can coexist with the original wire controller of the air conditioner brand11.
- ▶ The air conditioner can be controlled through Bluetooth, the parameters of the internal and external units of the air conditioner can be obtained, and the fault code of the air conditioner can be displayed, which is convenient for maintenance personnel to find problems.
- ▶ One circuit for multiple air conditioner brands, simple wiring and easy wiring.
- ▶ Support remote fault location function, which can quickly locate problems and provide fast service response.

---

NOTE 1: THIS FUNCTION REQUIRES THE ORIGINAL AIR CONDITIONER TO SUPPORT THE MASTER-SLAVE WIRE CONTROLLER FUNCTION.



## OVERVIEW

### 1) LED indicator light

indicator light for the working status of the air conditioner and this product. For details, please refer to the LED instructions.

### 2) SET button

Different functions can be realized by pressing the button. For details, please refer to the instruction of the button.

### 3-4) Air conditioner interface

Air conditioner access interface (see Chapter 4 of this manual for supported air conditioner brands).

### 5) TIS-BUS Connection Terminal

### 6) Power output port

It can provide input power for third-party temperature control panels, etc., and the output power of this port is DC7~15V, 0.7W(MAX).3.2

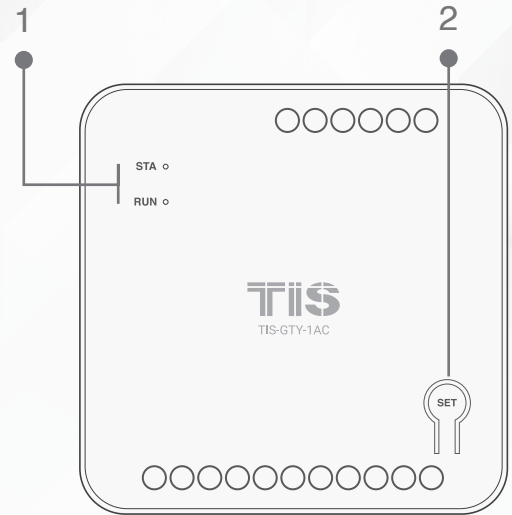

FRONT VIEW

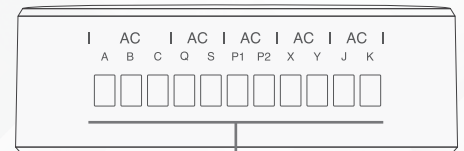

BOTTOM SIDE

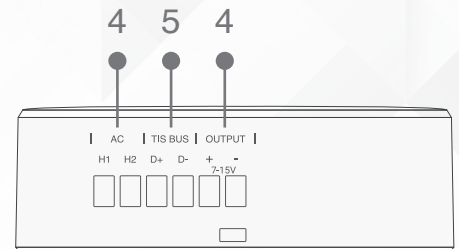

TOP SIDE



### BUTTON DEFINITION

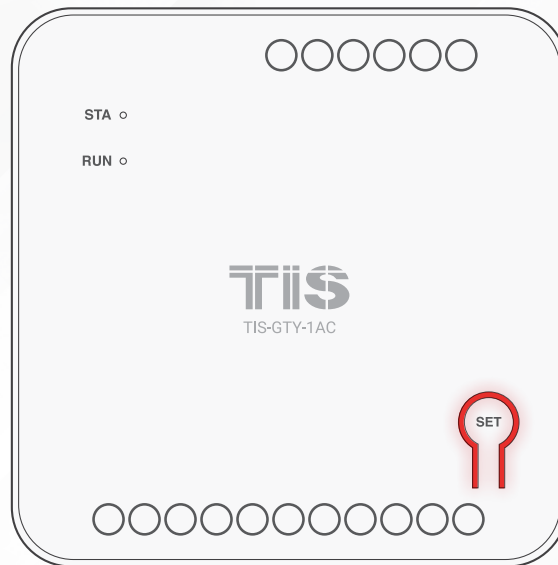

Button name	Funcation
-------------	-----------

<b>SET key</b>	Short press the SET button to gain control after Bluetooth connection.
----------------	--





### LED INDICATOR

- ▶ The indicator light flashes quickly: it is on for 0.25s and off for 0.25s, which is a quick flash.
- ▶ The indicator light flashes slowly: it is on for 0.5s and off for 0.5s, which is a slow flash.

Name	light status	Description
RUN	always on	Found the air conditioner and it works normally
	Flash	air conditioner search
	Often off	No air conditioner found
STA	always on	air conditioner on
	Flash	Abnormal air conditioner
	Slow flash	The third-party temperature control panel is abnormal
	Often off	air conditioner off

### LED COMBINATION OF LIGHTS

Name	light status	Description
RUN+STA	Flash 3 times	Bluetooth wireless connection is successful



### HARDWARE CONFIGURATION

- 1 Confirm that the air conditioning system is powered on, and check whether all connected indoor and outdoor units of the air conditioner are powered on.

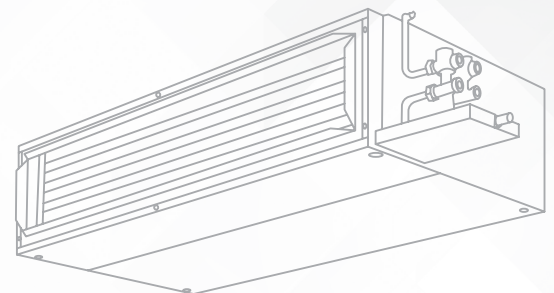

### **HARDWARE CONFIGURATION**

- 2** » Confirm that the air conditioning system has been debugged and operated successfully by the air conditioner manufacturer without any alarm or abnormality.
- 3** » Confirm that the communication line of the air conditioner has been connected to the corresponding interface of this product.
- 4** » Confirm that the third-party temperature control panel has been connected to the corresponding interface of this product (if necessary).

### **INSTALLATION ENVIRONMENT AND WIRING DIAGRAM**

According to the site conditions, it should be installed in the inspection port of the indoor unit or in the reserved smart box.

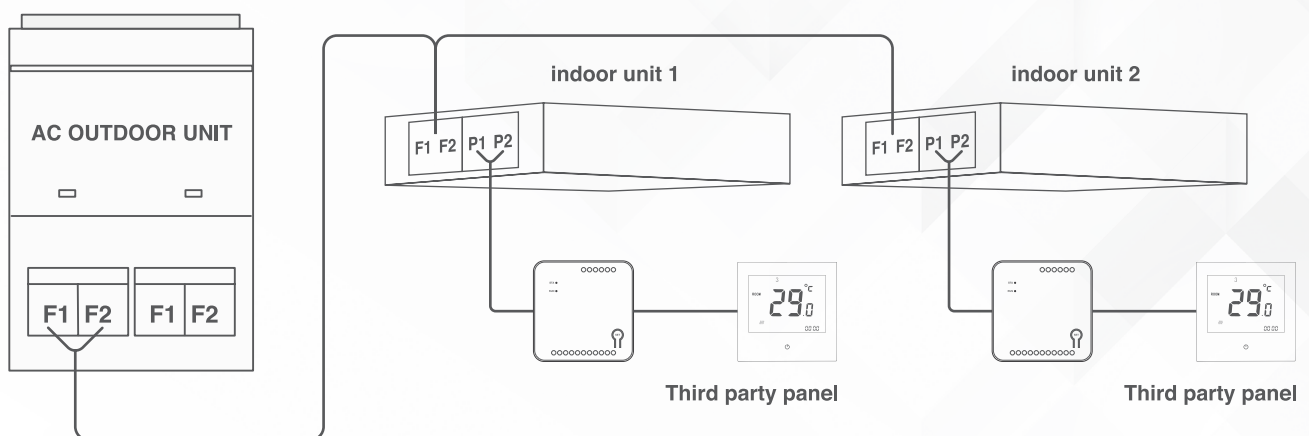

Figure 1: This product is connected to the air conditioner internal unit system diagram



## SUPPORTED BRAND LIST AND DESCRIPTION

The supported air conditioner brands and the wiring methods of each air conditioner brand are shown in the table below, and more brands are being connected and supported one after another :

Brand	Wiring Method		Wiring polarity	Cable	Coexistence of original factory wire controller
	Gateway side wiring port	Air conditioner side wiring port			
Daikin Online (2 cores)	P1, P2	P1, P2	none	2	Support
Daikin MX air duct machine (4 cores)	K to Pin 1 J to pin 2 Q to pin 3 S to pin 4 Pin 5 is empty	S21 (5 pins)	Yes	4	not support
Hitachi Multi-connection (2 cores)	P1, P2	A, B	none	2	Support
Hitachi duct machine (4 cores)	S to pin 1 Q to pin 2 J to pin 3 K to pin 4	CN2 (4pins)	Yes	4	not support
Hisense multi-connection (2 cores)	P1, P2	A, B	none	2	Support
Hisense N+ Air Duct (4 Core)	J to pin 1 Q to pin 2 S to pin 3 K to pin 4	X950 / WiFi Terminal (4 pins)	Yes	4	Support
York more online (2 cores)	P1, P2	A, B	none	2	Support
Toshiba Multi (2 cores)	X, Y	A, B	none	2	Support
Panasonic Multi (2 cores)	X, Y	CN041 outside 2pin A, B	none	2	Support
Mitsubishi Heavy Industries Multi-line (2 cores)	P1, P2	CNB Pin 1 , Pin 3 X, Y	none	2	Support
Mitsubishi Heavy Industries Multi-line (3 cores)	K to Pin 1 Q and S parallel, to Pin 2 J to pin 3	CNB	Yes	3	Support
Media Cool Free (4 cores) No remote	Q to pin 1 S to pin 2 K to pin 3 J to pin 4	CN40	Yes	4	not support
Media Cool free coaxial 4 core with remote	S to pin 1 Q to pin 2 K to pin 3 J to pin 4	CN40 RED (4 pins)	Yes	4	Support

Figure 2: Brand Connection Method





## SUPPORTED BRAND LIST AND DESCRIPTION

Brand	Wiring Method		Wiring polarity	Cable	Coexistence of original factory wire controller
	Gateway side wiring port	Air conditioner side wiring port			
Midea (5-core CN20)	J to Pin 1 Q to Pin 2 and 3 S to pin 4 K to pin 5	CN20	Yes	4	Support
Haier (3 cores)	A to pin 1 B to pin 2 C to pin 3	CN22 terminal (3 pins)	Yes	3	not support
Haier duct machine centralized control (REMOTE terminal)	K to pin 1 Q, S to pin 2 J to pin 3	CN4 REMOTE Blue terminal	Yes	3	Support
Haier duct machine centralized control (without Wall remote control)	Q, S to Pin 2 K to pin 3 J to pin 4	CN1 or CN2	Yes	4	not support
Gree (2 cores)	P1, P2	H1, H2	None	2	Support
Gree duct machine (2 cores)	H1 to pin 3 H2 to pin 2	Pin 3, 2 of COM_ MANUAL terminal	Yes	2	Support
Gree duct machine (4 cores)	J to pin 1 S to pin 2 Q to pin 3 K to pin 4	CN5 or CN6	Yes	4	not support
Mitsubishi Electric Multi-line (4 cores)	Q to pin 2 S to pin 3 K to pin 4 J to pin 5	CN105 (Link pin 5-2) pin 1 Empty	Yes	4	Support
Carrier duct machine (4 cores)	J to pin 1 Q and S parallel to pin 2 K to pin 3	CN24 or CN26	Yes	4	Support
Fujitsu	J to 1 Q,S to Terminal 2 K to 3	CN14 1,2,3 Remote Controller Terminal	Yes	3	Support

Figure 3: Brand Connection Method

- ▶ When the TIS-GTY-1AC wire controller gateway and the original wire controller coexist, you need to set the master-slave (only applicable to brands that support coexistence and need to dial codes, if you do not keep the original wire controller, please skip this step).



### CHANGING THE ORIGINAL WIRE CONTROLLER TO SLAVE WIRE CONTROLLER

AC Brand	Can coexist	Setting method
<b>Daikin</b>	Coexistence needs to be set	C,E,H The original remote control of the series is set through the dial switch on the back, and dialed to Slave. F series original wire control enters the menu setting by long pressing the cancel button, selects the master-slave setting, and sets it as slave.
<b>Hitachi</b>	Can coexist without setting can not coexist	Wire controllers such as 3Q 6Q EQ are directly connected in parallel, and no settings are required for automatic parent-child identification. The 8Q 9Q wire controller does not support parent-child sharing, and the original wire controller must be removed.
<b>Ttoshiba</b>	Coexistence needs to be set	Dial 1 on the back of the 86 wire controller to ON for slave. 120. Switch the dial SW2 on the back of the wire controller to ON to be the slave.
<b>Mitsubishi Heavy Industries</b>	Coexistence needs to be set	Flip cover wire controller is set through SW1 on the back, dial to Slave. Touch the wire controller to power on, it will prompt whether to use the previous settings, select no, and then prompt again to select slave.
<b>Hitachi US</b>	can not coexist	The original wire controller must be removed.
<b>Haier duct</b>	can not coexist	Sharing is not supported, and the original wire controller must be removed.
<b>Midea</b>	can not coexist	Sharing is not supported, and the original wire controller must be removed.

### CAUTION AND AVOIDS

PAY ATTENTION TO THE FOLLOWING POINTS WHEN WIRING

**1**» The polarity of the communication interface of different air conditioners will be different. If the polarity of the cable connection is wrong, the air conditioner will not be found. In this case, the cable sequence needs to be changed.

**WARNING:** If the wiring is wrong, it may cause damage to the product.

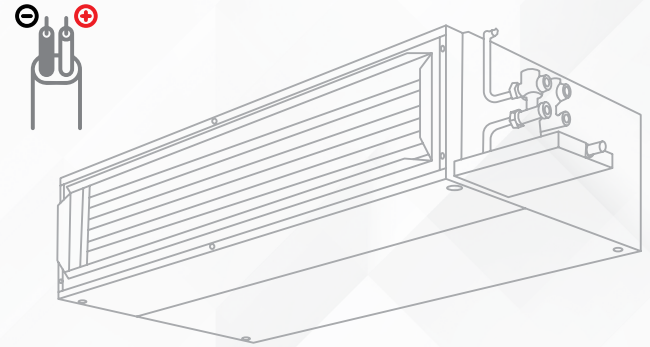

**2**» Be sure to cut off the power supply of the air conditioner during wiring work, otherwise it may cause malfunction.



**3**» Please pay attention to avoid wiring between signal cables and power cables, otherwise, malfunctions may occur due to signal interference. If wiring side by side cannot be avoided, please keep the distance between the communication lines of this product and the communication lines of the air-conditioning system at least 15cm, and the distance with other wiring at least 30cm. Or connect the cable into the iron protection tube and ground one end of the protection tube.

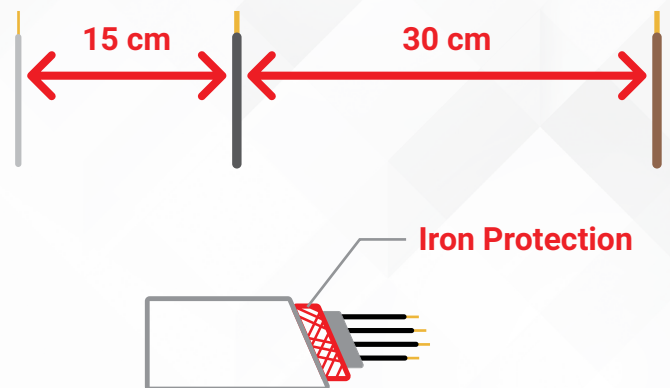

**4»** It is strictly forbidden to connect the AC220V power line to the signal terminal, otherwise the internal electronic components of the wire controller gateway will be burned. If this happens due to misuse, please contact the manufacturer, and it is strictly forbidden to disassemble and repair without permission.

## APP CONFIGURATION

**1»** Install “Wechat” application, turn on the phone’s Bluetooth and scan this QR code by your wechat app.



**2»** select the TIS-GTY-1AC Firmware B25-\*\*\*\* wire controller gateway device to be connected.

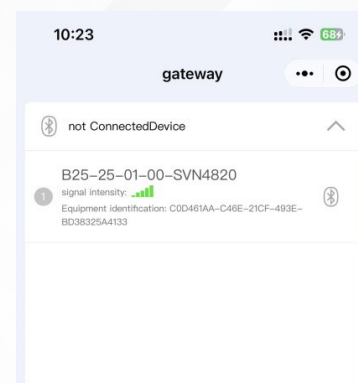

**3** In the interface down bar, select upgrade , then chose your AC brand and type.

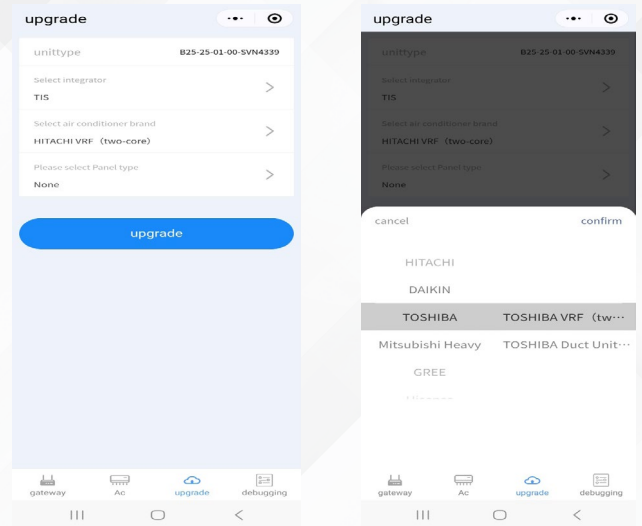

**4** In the interface down bar, you can select “AC” to control the air conditioner.

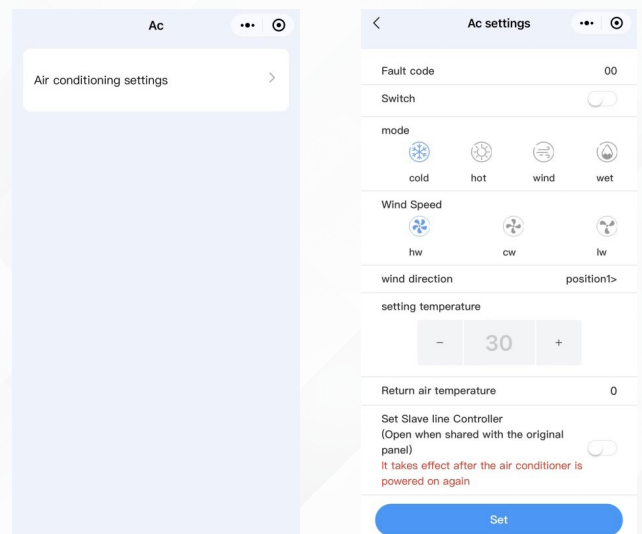

Parameter acquisition: We can obtain the operating parameters of the indoor unit of the air conditioner through the Bluetooth applet to help maintenance personnel overhaul the air conditioner



Parameter acquisition: We can obtain the operating parameters of the indoor unit of the air conditioner through the Bluetooth applet to help maintenance personnel overhaul the air conditioner

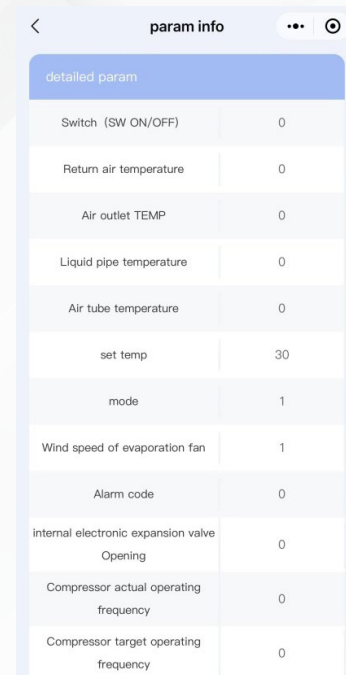

param info	
detailed param	
Switch (SW ON/OFF)	0
Return air temperature	0
Air outlet TEMP	0
Liquid pipe temperature	0
Air tube temperature	0
set temp	30
mode	1
Wind speed of evaporation fan	1
Alarm code	0
internal electronic expansion valve Opening	0
Compressor actual operating frequency	0
Compressor target operating frequency	0

The gateway ID can be set through the Bluetooth applet, and the setting range (1-32). The control terminal controls the gateway through the set ID. When the centralized control terminal is powered on, it should use polling to determine the number and ID of connected gateways for subsequent polling.

If there is any inconsistency between the product manual and the description on the official website, please refer to the description on the official website/official account. The function of the product itself is perfected and upgraded without prior notice.

