

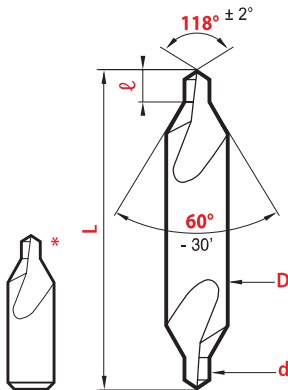

# Forets à centrer • Center drills

Brocas de centrar • Punte a centrare

## 60° Forme A • Form A • Forma A

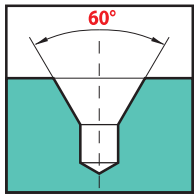

Le foret à centrer 60° norme ISO est le type le plus universel. **Magafor** en offre huit qualités couvrant tous les cas d'usinage.

The ISO standard 60° center drill is the most universal type. **Magafor** offers eight different options to answer all machining needs.

La broca de centrar norma ISO 60° es el tipo más universal. **Magafor** ofrece ocho calidades cubriendo todos los casos de mecanizado.

La punta a centrare a 60° a norma ISO rappresenta la tipologia universale. **Magafor** ne offre otto qualità per coprire tutte le necessità di lavorazione.



ISO • NFE 66051-A  
DIN 333-A • JIS-1

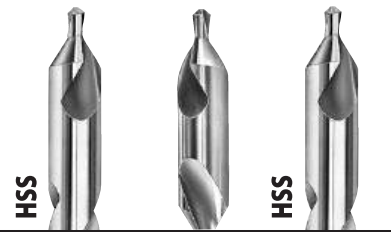

Type Tipo			HSS		HSS	
D x d	L	ℓ	magafor 11	magafor 16	Classic 03	
h7 k12	± 1	mini maxi				
3,0 x 0,5	31	0,6 ~ 0,9	11,80 €			
3,15 x 0,5*	25	0,6 ~ 0,9	5,71 €	8,87 €	4,62 €	
3,15 x 0,63*	25	0,7 ~ 1,0	5,71 €	8,87 €		
3,15 x 0,8*	25	1,0 ~ 1,3	5,71 €	8,87 €	4,62 €	
3,15 x 1,0	31	1,3 ~ 1,7	5,71 €	8,87 €	4,62 €	
3,15 x 1,25	31	1,6 ~ 2,0	5,71 €	8,87 €	4,62 €	
3,5 x 0,75	35	1,0 ~ 1,3	6,69 €	10,94 €		
4,0 x 1,0	35	1,3 ~ 1,7	5,96 €	10,94 €	4,62 €	
4,0 x 1,25	35	1,6 ~ 2,0	5,96 €	10,94 €		
4,0 x 1,6	35	2,0 ~ 2,6	5,96 €	9,00 €	4,74 €	
5,0 x 1,5	40	2,0 ~ 2,6	6,46 €	11,55 €	4,98 €	
5,0 x 1,6	40	2,0 ~ 2,6	6,69 €	11,55 €		
5,0 x 2,0	40	2,5 ~ 3,1	6,46 €	9,85 €	4,98 €	
6,0 x 2,0	45	2,5 ~ 3,1	7,18 €	13,06 €	5,71 €	
6,3 x 2,0	45	2,5 ~ 3,1	7,42 €	13,06 €		
6,3 x 2,5	45	3,1 ~ 3,8	7,18 €	11,08 €	5,71 €	
8,0 x 2,5	50	3,1 ~ 3,8	8,28 €	15,50 €	6,56 €	
8,0 x 3,0	50	3,9 ~ 4,6	8,28 €	15,50 €	6,56 €	
8,0 x 3,15	50	3,9 ~ 4,6	8,28 €	13,37 €	6,56 €	
10,0 x 3,0	55	3,9 ~ 4,6	10,71 €	20,68 €	8,50 €	
10,0 x 3,15	55	3,9 ~ 4,6	10,82 €	20,68 €		
10,0 x 4,0	55	5,0 ~ 5,9	10,71 €	17,63 €	8,50 €	
12,0 x 4,0	63	5,0 ~ 5,9	17,94 €	29,18 €	14,29 €	
12,0 x 5,0	63	6,3 ~ 7,2	17,94 €	29,18 €	14,29 €	
12,5 x 4,0	63	5,0 ~ 5,9	18,24 €	29,18 €		
12,5 x 5,0	63	6,3 ~ 7,2	17,94 €	26,15 €	14,29 €	
14,0 x 5,0	69	6,3 ~ 7,2	23,42 €	43,78 €		
16,0 x 5,0	71	6,3 ~ 7,2	26,75 €	54,73 €		
16,0 x 6,3	71	8,0 ~ 8,9	25,84 €	49,25 €	20,68 €	
18,0 x 6,0	77	8,0 ~ 8,9	37,69 €			
20,0 x 6,3	80	8,0 ~ 8,9	51,68 €			
20,0 x 8,0	80	10,1 ~ 11,1	48,64 €	85,73 €	38,92 €	
25,0 x 8,0	100	10,1 ~ 11,1	86,35 €			
25,0 x 10,0	100	12,8 ~ 13,8	86,35 €		72,37 €	
31,5 x 10,0	125	12,8 ~ 13,8	203,10 €			
31,5 x 12,5	125	16,5 ~ 17,5	197,01 €			

\*D'un seul côté Single end De una sola punta Ad un solo lato

### Prouo-kits 30

Quantité Quantity Cantidad Quantità	magafor 110/1	magafor 110/2
5 pièces de chaque Ø 5 pieces of each Ø 5 pieza de cada Ø 5 pezzi per ogni Ø	1,0 x 3,15 1,6 x 4,0 2,0 x 5,0 2,5 x 6,3 3,15 x 8,0	0,5 x 3,0 1,0 x 4,0 1,5 x 5,0 2,0 x 6,0 2,5 x 8,0
4 pieces pieza pezzi	4,0 x 10,0	3,0 x 10,0
1 piece pieza pezzo	5,0 x 12,5	4,0 x 12,0
	217,69 €	217,69 €

### Prouo-kits 15

Quantité Quantity Cantidad Quantità	magafor 110/3	magafor 110/4
3 pièces de chaque Ø 3 pieces of each Ø 3 pieza de cada Ø 3 pezzi per ogni Ø	1,0 x 4,0 1,5 x 5,0 2,0 x 6,0 2,5 x 8,0 3,0 x 10,0	1,6 x 4,0 2,0 x 5,0 2,5 x 6,3 3,15 x 8,0 4,0 x 10,0
2 pièces pieza pezzi	4,0 x 12,0	5,0 x 12,5
1 pièce pieza pezzo	5,0 x 12,5	4,0 x 12,0
	120,39 €	120,39 €



ISO • NFE 66051-A  
DIN 333-A • JIS-1

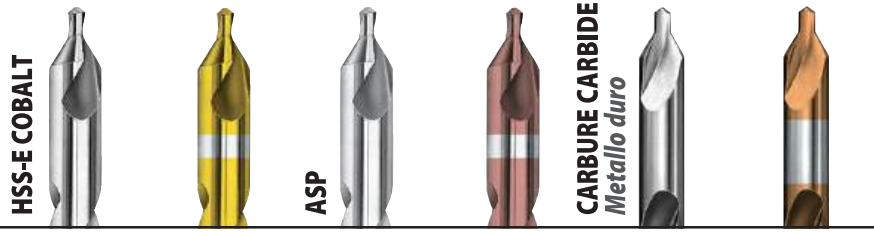

D x d h7 <sup>(1)</sup> k12	L ± 1	ℓ mini maxi	magafor 10	TIN 0811	magafor 105	Red'X 0910	magaforce 8100	Hard'X 8100-H
3,15 x 0,5 <sup>(2)</sup>	25	0,6 ~ 0,9	8,02 €	13,26 €	12,77 €	24,68 €	41,34 €	46,82 €
3,15 x 0,6 <sup>(2)</sup>	25	0,6 ~ 0,9					41,34 €	46,82 €
3,15 x 0,8 <sup>(2)</sup>	25	1,0 ~ 1,3	8,02 €	13,26 €			41,34 €	46,82 €
3,15 x 1,0	31	1,3 ~ 1,7	8,02 €	13,26 €	12,77 €	21,90 €	42,56 €	49,25 €
3,15 x 1,25	31	1,6 ~ 2,0	8,02 €	13,26 €	12,77 €	21,90 €	42,56 €	49,25 €
3,5 x 0,75	35	1,0 ~ 1,3	8,76 €	14,60 €				
4,0 x 1,0	35	1,3 ~ 1,7	8,15 €	13,37 €			43,78 €	50,47 €
4,0 x 1,6	35	2,0 ~ 2,6	8,15 €	13,37 €	12,89 €	22,49 €	43,78 €	50,47 €
5,0 x 1,5	40	2,0 ~ 2,6	9,00 €	14,23 €			54,73 €	62,02 €
5,0 x 2,0	40	2,5 ~ 3,1	9,00 €	14,23 €	13,49 €	23,42 €	54,73 €	62,02 €
6,0 x 2,0	45	2,5 ~ 3,1	10,22 €	16,18 €			65,07 €	74,18 €
6,3 x 2,5	45	3,1 ~ 3,8	10,22 €	16,18 €	16,05 €	26,46 €	65,07 €	74,18 €
8,0 x 2,5	50	3,1 ~ 3,8	11,67 €	18,36 €			79,04 €	90,00 €
8,0 x 3,0	50	3,9 ~ 4,6	11,67 €	18,36 €			79,04 €	90,00 €
8,0 x 3,15	50	3,9 ~ 4,6	11,67 €	18,36 €	18,36 €	30,71 €	79,04 €	90,00 €
10,0 x 3,0	55	3,9 ~ 4,6	14,89 €	24,20 €			105,19 €	119,19 €
10,0 x 4,0	55	5,0 ~ 5,9	14,89 €	24,20 €	24,02 €	39,52 €	105,19 €	119,19 €
12,0 x 4,0	63	5,0 ~ 5,9	24,02 €	41,23 €				
12,0 x 5,0	63	6,3 ~ 7,2	24,02 €	41,23 €			177,56 €	194,58 €
12,5 x 5,0	63	6,3 ~ 7,2	24,02 €	41,23 €	39,82 €	60,21 €	177,56 €	194,58 €
14,0 x 5,0	69	6,3 ~ 7,2	32,83 €	52,61 €				
16,0 x 6,3	71	8,0 ~ 8,9	43,78 €	62,64 €			280,92 €	301,61 €
20,0 x 8,0	80	10,1 ~ 11,1	91,83 €	112,50 €				
25,0 x 10,0	100	12,8 ~ 13,8	155,06 €	179,39 €				

(1) CARBURE CARBIDE METAL DURO METALLO DURO = h5 (2) Un seul côté Single end De una sola punta Ad un solo lato

## magafor *Le choix! The choice! La elección! La scelta!*

Matière Material Materiale	HSS	HSS-E COBALT	HSS-E COBALT + TIN	ASP	ASP + Red'X	CARBURE VHM Metallo duro	CARBURE VHM + Hard'X
Dureté Hardness Durezza	63 HRC	65 HRC	65 HRC + 2300 HV	67 HRC	67 HRC + 3500 HV	1800 HV	1800 HV + 3500 HV
Utilisation Use Utilización Impiego	Petites séries Small series Pequeñas series Piccole serie	Production intensive Intensive production Producción intensiva Produzione intensiva		Alliages durs et abrasifs Hard and abrasive alloys Aleaciones duras y abrasivos Leghe dure e abrasive		Aciers trempés Treated steels Aceros tratados Acciai temprati	



Emballage Packaging  
Embalaje Imballo

**magafor 10-11 Classic 03**  
10 pièces piezas pezzi D x d ≤ 10 x 4

## Avec plat With flat Con plano Con piano

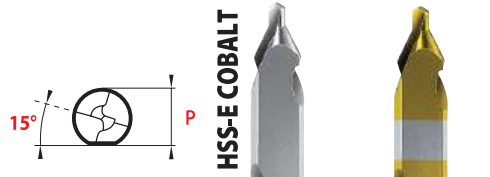

D x d h7 k12	L ± 1	ℓ mini maxi	P -0,1	magafor 0290	TIN 0890
4,0 x 1,6	35	2,0 ~ 2,6	3,25	9,23 €	14,48 €
5,0 x 2,0	40	2,5 ~ 3,1	4,2	10,34 €	16,05 €
6,3 x 2,5	45	3,1 ~ 3,8	5,35	11,31 €	17,87 €
8,0 x 3,15	50	3,9 ~ 4,6	6,95	13,68 €	20,36 €
10,0 x 4,0	55	5,0 ~ 5,9	8,4	21,40 €	31,02 €
12,5 x 5,0	63	6,3 ~ 7,2	10,95	29,18 €	47,42 €
16,0 x 6,3	71	8,0 ~ 8,9	14	47,42 €	66,27 €
20,0 x 8,0	80	10,1 ~ 11,1	17,9	74,79 €	
25,0 x 10,0	100	12,8 ~ 13,8	22,5	131,34 €	



# Forets à centrer • Center drills

Brocas de centrar • Punte a centrare

## 60°

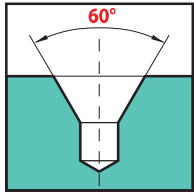

Tolérances Tolerancias Tolleranze

D	d	$\alpha$	
		60°	118°
	0,5 ~ 1,5 ± 0,05		
h7	2,0 ~ 4,0 ± 0,08	- 30'	± 2°
	5,0 ~ 6,0 ± 0,12		



Emballage Packaging

Embalaje Imballo

**magafor 117-118**

10 pièces piezas pezzi D x d ≤ 10 x 4



HSS



HSS-E COBALT



D x d	L ± 1	ℓ		magafor 117	magafor 118	TIN 0818
		mini	maxi			
3,0 x 0,5	31	0,6 ~ 0,9			11,93 €	16,05 €
4,0 x 0,8	35	0,9 ~ 1,3			8,15 €	12,16 €
4,0 x 1,0	35	1,2 ~ 1,5		5,89 €	6,56 €	10,58 €
5,0 x 1,2	40	1,3 ~ 1,8		6,56 €	7,30 €	11,31 €
5,0 x 1,5*	40	1,5 ~ 2,0		6,56 €	7,30 €	11,31 €
5,0 x 1,5*	42	1,8 ~ 2,4			7,30 €	
5,0 x 2,0*	40	2,0 ~ 2,5		6,56 €		
5,0 x 2,0*	42	2,4 ~ 3,0			7,30 €	
6,0 x 2,0	45	2,0 ~ 2,5		7,45 €	8,28 €	13,01 €
6,0 x 2,5*	45	3,1 ~ 3,8		7,87 €	8,76 €	13,49 €
6,0 x 2,5*	47	3,0 ~ 3,7			8,76 €	
7,7 x 2,5*	50	2,5 ~ 3,0			9,85 €	16,54 €
7,7 x 2,5*	57	2,5 ~ 3,0		8,85 €	9,85 €	16,54 €
7,7 x 3,0	57	3,0 ~ 3,6		8,85 €	9,85 €	16,54 €
7,7 x 3,2	57	3,2 ~ 3,8		8,85 €	9,85 €	16,54 €
8,0 x 3,0*	50	3,9 ~ 4,6		9,68 €	10,77 €	17,46 €
8,0 x 3,0*	53	3,8 ~ 4,5			10,77 €	
8,0 x 3,2	50	3,9 ~ 4,6		9,68 €	10,77 €	17,46 €
10,0 x 4,0*	65	4,5 ~ 5,1		10,29 €	11,43 €	20,74 €
10,0 x 4,0*	69	4,5 ~ 5,1		11,76 €	13,06 €	21,65 €
11,0 x 4,0	69	4,5 ~ 5,1		18,62 €	20,68 €	37,88 €
11,0 x 5,0*	69	5,5 ~ 6,1		18,62 €	20,68 €	37,88 €
11,0 x 5,0*	78	5,5 ~ 6,1		20,26 €	22,49 €	39,72 €
16,0 x 6,0	90	7,0 ~ 8,0		38,30 €	42,56 €	57,77 €
18,0 x 6,0	95	7,0 ~ 8,0		41,59 €	46,22 €	63,85 €

\*Préciser la longueur totale L  
Precisar la longitud total L

Overall length L has to be mentioned  
Precisare la lunghezza totale L



HSS

## Hors normes No normalized standard

Fuera de normas

Misure non

normalizzate

magafor standard

D x d	L ± 1	ℓ		magafor 110	D x d	L ± 1	ℓ		magafor 110
		mini	maxi				mini	maxi	
2,0 x 0,5	31	0,6 ~ 0,9		36,65 €	8,0 x 2,0	50	2,5 ~ 3,1		22,49 €
2,0 x 0,75	31	1,0 ~ 1,3		33,75 €	8,0 x 3,5	50	4,4 ~ 5,1		22,49 €
2,5 x 0,75	31	1,0 ~ 1,3		33,75 €	8,0 x 4,0	50	5,0 ~ 5,9		22,49 €
3,0 x 0,3	31	0,3 ~ 0,4		36,65 €	10,0 x 2,0	55	2,5 ~ 3,1		26,15 €
3,0 x 0,4	31	0,5 ~ 0,7		36,65 €	10,0 x 2,5	55	3,1 ~ 3,8		26,15 €
3,0 x 0,75	31	1,0 ~ 1,3		18,24 €	10,0 x 3,5	55	4,4 ~ 5,1		26,15 €
3,0 x 1,0	31	1,3 ~ 1,7		18,24 €	10,0 x 5,0	55	6,3 ~ 7,2		26,15 €
3,5 x 0,5	35	0,6 ~ 0,9		18,24 €	12,0 x 2,5	63	3,1 ~ 3,8		41,34 €
4,0 x 0,75	35	1,0 ~ 1,3		18,24 €	12,0 x 3,0	63	3,9 ~ 4,6		41,34 €
4,0 x 1,5	35	2,0 ~ 2,6		18,24 €	12,0 x 3,5	63	4,4 ~ 5,1		41,34 €
4,0 x 2,0	35	2,5 ~ 3,1		18,24 €	12,0 x 6,0	63	8,0 ~ 8,9		41,34 €
5,0 x 1,0	40	1,3 ~ 1,7		18,24 €	14,0 x 3,0	69	3,9 ~ 4,6		60,21 €
5,0 x 2,5	40	3,1 ~ 3,8		18,24 €	14,0 x 4,0	69	5,0 ~ 5,9		60,21 €
6,0 x 1,0	45	1,3 ~ 1,7		18,24 €	14,0 x 6,0	69	8,0 ~ 8,9		60,21 €
6,0 x 1,5	45	2,0 ~ 2,6		18,24 €	16,0 x 4,0	71	5,0 ~ 5,9		76,61 €
6,0 x 2,5	45	3,1 ~ 3,8		18,24 €	16,0 x 6,0	71	8,0 ~ 8,9		76,61 €
6,0 x 3,0	45	3,9 ~ 4,6		18,24 €	18,0 x 5,0	77	6,3 ~ 7,2		96,69 €
7,0 x 2,5	50	3,1 ~ 3,8		22,49 €	20,0 x 7,0	80	9,0 ~ 9,9		150,81 €
7,5 x 2,5	50	3,1 ~ 3,8		22,49 €	22,0 x 6,0	100	8,0 ~ 8,9		232,28 €
8,0 x 1,5	50	2,0 ~ 2,6		22,49 €					

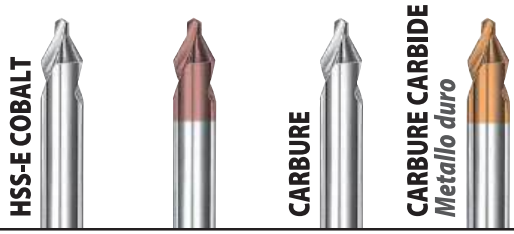

# 60° Longs et extra-long

## Long reach series

Largas y extra-largas

Serie lunga ed extra lunga

magafor standard

L <sup>(1)</sup> ± 1	D x d		ℓ mini maxi	magafor	Red'X	magaforce	Hard'X
	h7 <sup>(2)</sup>	k12		18	0918	8118	8118-H
60	3,5 x 0,75		1,0 ~ 1,3	12,16 €			
	4,0 x 1,0		1,3 ~ 1,7	12,04 €			
	5,0 x 1,5		2,0 ~ 2,6	11,67 €			
80	6,0 x 2,0		2,5 ~ 3,1	12,47 €			
	8,0 x 2,5		3,1 ~ 3,8	15,80 €			
	8,0 x 3,0		3,9 ~ 4,6	15,80 €			
100	4,0 x 1,0		1,3 ~ 1,7	21,28 €	36,00 €	102,00 €	108,93 €
	5,0 x 1,5		2,0 ~ 2,6	20,68 €			
	6,0 x 2,0		2,5 ~ 3,1	20,68 €	38,35 €	105,00 €	115,53 €
	8,0 x 2,5		3,1 ~ 3,8	20,68 €			
	8,0 x 3,0		3,9 ~ 4,6	20,68 €	39,52 €	146,00 €	158,10 €
	10,0 x 3,0		3,9 ~ 4,6	20,68 €			
	10,0 x 4,0		5,0 ~ 5,9	20,68 €	41,34 €	192,00 €	206,74 €
	12,0 x 4,0		5,0 ~ 5,9	27,67 €			
120	12,0 x 5,0		6,3 ~ 7,2	27,67 €			
	3,5 x 0,75		1,0 ~ 1,3	39,52 €			
	4,0 x 1,0		1,3 ~ 1,7	28,28 €			
	5,0 x 1,5		2,0 ~ 2,6	27,67 €			
	5,0 x 1,6		2,0 ~ 2,6	27,67 €			
	6,0 x 2,0		2,5 ~ 3,1	27,67 €			
	8,0 x 2,5		3,1 ~ 3,8	32,23 €			
	8,0 x 3,0		3,9 ~ 4,6	32,23 €			
	10,0 x 3,0		3,9 ~ 4,6	37,09 €			
	10,0 x 3,15		3,9 ~ 4,6	37,09 €			
150	10,0 x 4,0		5,0 ~ 5,9	37,09 €			
	12,0 x 4,0		5,0 ~ 5,9	44,99 €			
	14,0 x 5,0		6,3 ~ 7,2	55,33 €			
	4,0 x 1,0		1,3 ~ 1,7	33,44 €			
	5,0 x 1,5		2,0 ~ 2,6	33,44 €			
	6,0 x 2,0		2,5 ~ 3,1	33,44 €			
	8,0 x 2,5		3,1 ~ 3,8	38,31 €			
	8,0 x 3,0		3,9 ~ 4,6	38,31 €			
200	10,0 x 3,0		3,9 ~ 4,6	43,78 €			
	10,0 x 4,0		5,0 ~ 5,9	43,78 €			
	12,0 x 4,0		5,0 ~ 5,9	53,51 €			
	16,0 x 6,3		8,0 ~ 8,9	79,04 €			
	5,0 x 2,0		2,5 ~ 3,1	69,93 €			
	6,3 x 2,5		3,1 ~ 3,8	68,71 €			
	8,0 x 3,15		3,9 ~ 4,6	65,07 €			
10,0 x 4,0		5,0 ~ 5,9	71,14 €				

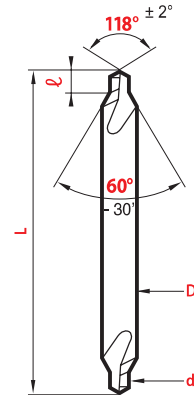
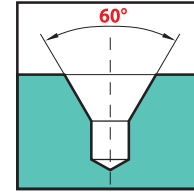

**Hard-X**  
Jusqu'à  
up to  
Hasta  
Fino a 67 HRC

(1) Si "L" non indiquée: livraison en longueur 100 mm  
When "L" is not mentioned: 100 mm overall will be delivered  
Si no se especifica "L": entrega con longitud de 100mm  
Se "L" non viene indicata: consegna in lunghezza 100 mm

(2) CARBURE CARBIDE METAL DURO METALLO DURO = h5

## promo-kits

HSS-Co

6 pièces pieces piezza pezzi		magafor 180
4 x 1 L 60	5 x 1,5 L 60	96,07 €
6 x 2 L 80	8 x 2,5 L 80	
10 x 3 L 100	12 x 4 L 100	





# Forets à centrer • Center drills

Brocas de centrar • Punte a centrare

## Cotes en pouces

### Sizes in inches

Medidas en pulgadas

Misure in pollici

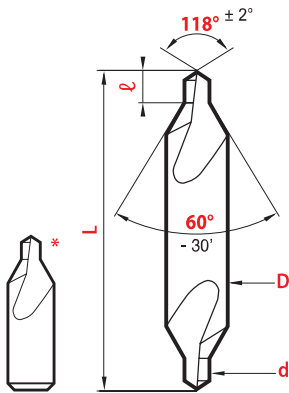
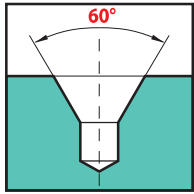

Emballage Packaging

Embalaje Imballo

**magafor 114-115**

10 pièces *piezas pezzi* D x d ≤ 10 x 4

A N° 00000 ~ 5



60°

HSS



HSS-E 8% COBALT



ASA N°	D x d h7 k12	L ± 1	ℓ mini maxi	magafor 115	TIN 08115	magafor 1055	Red'X 0915
Forets d'un seul côté* Single end drills		Brocas de una sola punta		Punte ad un solo lato			
<b>A</b> 00000	3,17 x 0,25 (1/8 x .010)	31	0,2 ~ 0,45	24,93 €	29,80 €	27,67 €	38,31 €
<b>B</b> 0000	3,17 x 0,38 (1/8 x .015)	31	0,35 ~ 0,65	18,55 €	23,47 €	20,68 €	32,84 €
<b>C</b> 000	3,17 x 0,51 (1/8 x .020)	31	0,5 ~ 0,8			18,55 €	31,02 €
<b>D</b> 00	3,17 x 0,63 (1/8 x .025)	31	0,7 ~ 1,0			17,33 €	27,36 €
<b>E</b> 0	3,17 x 0,79 (1/8 x 1/32)	31	0,9 ~ 1,2			14,89 €	24,33 €
Forets doubles Double end drills		Brocas de doble punta		Punte doppie			
<b>C</b> 000	3,17 x 0,51 (1/8 x .020)	31	0,5 ~ 0,8	13,37 €	18,85 €		
<b>D</b> 00	3,17 x 0,63 (1/8 x .025)	31	0,7 ~ 1,0	10,34 €	15,57 €		
<b>E</b> 0	3,17 x 0,79 (1/8 x 1/32)	31	0,9 ~ 1,2	6,69 €	11,92 €		
<b>F</b> 1/0	3,17 x 1,02 (1/8 x .040)	31	1,0 ~ 1,3	6,69 €	11,92 €	17,33 €	
<b>1</b>	3,17 x 1,19 (1/8 x 3/64)	31	1,4 ~ 1,7	5,96 €	11,31 €	11,43 €	22,98 €
<b>2</b>	4,76 x 1,98 (3/16 x 5/64)	47	2,4 ~ 2,7	6,20 €	11,67 €	12,16 €	23,83 €
<b>3</b>	6,35 x 2,77 (1/4 x 7/64)	50	3,3 ~ 3,9	7,18 €	13,49 €	13,68 €	25,54 €
<b>4</b>	7,93 x 3,17 (5/16 x 1/8)	54	3,8 ~ 4,4	8,15 €	14,96 €	15,80 €	27,36 €
<b>4-1/2</b>	9,52 x 3,57 (3/8 x 9/64)	63	4,3 ~ 4,9	11,67 €	21,90 €	23,11 €	
<b>5</b>	11,11 x 4,76 (7/16 x 3/16)	70	5,9 ~ 6,5	14,89 €	28,82 €	29,49 €	34,06 €
<b>6</b>	12,70 x 5,55 (1/2 x 7/32)	76	6,9 ~ 7,5	17,94 €	31,98 €	34,06 €	51,39 €
<b>7</b>	15,87 x 6,35 (5/8 x 1/4)	82	8,0 ~ 8,6	25,84 €	58,98 €	50,47 €	74,18 €
<b>8</b>	19,05 x 7,93 (3/4 x 5/16)	89	10,0 ~ 10,6	47,42 €	108,23 €	95,46 €	138,65 €
<b>9</b>	22,22 x 8,73 (7/8 x 11/32)	92	11,0 ~ 11,6	63,24 €	144,71 €	133,78 €	
<b>10</b>	25,40 x 9,52 (1 x 3/8)	95	12,1 ~ 12,7	79,04 €	181,20 €	170,27 €	



60°

CARBURE CARBIDE

METAL DURO METALLO DURO

ASA N°	D x d h5 k12	L ± 1	ℓ mini maxi	magaforce 8105	Hard'X 8105-H
<b>D</b> 00	3,17 x 0,63 (1/8 x .025)	31	0,7 ~ 1,0	54,73 €	62,64 €
<b>E</b> 0	3,17 x 0,79 (1/8 x .020)	31	0,9 ~ 1,2	48,64 €	56,55 €
<b>1</b>	3,17 x 1,19 (1/8 x 3/64)	31	1,4 ~ 1,7	42,56 €	50,47 €
<b>2</b>	4,76 x 1,98 (3/16 x 5/64)	47	2,4 ~ 2,7	54,73 €	62,02 €
<b>3</b>	6,35 x 2,77 (1/4 x 7/64)	50	3,3 ~ 3,9	66,89 €	76,01 €
<b>4</b>	7,93 x 3,17 (5/16 x 1/8)	54	3,8 ~ 4,4	79,04 €	90,00 €
<b>5</b>	11,11 x 4,76 (7/16 x 3/16)	70	5,9 ~ 6,5	152,03 €	166,61 €
<b>6</b>	12,70 x 5,55 (1/2 x 7/32)	76	6,9 ~ 7,5	194,58 €	211,61 €





82°-90°

HSS

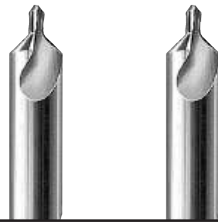

60°

HSS



ASA N°	D x d h7 k12	L ± 1	ℓ mini maxi	82° 154	90° 155
1	3,17 x 1,19 (1/8 x 3/64)	31	1,4 ~ 1,7	14,29 €	14,29 €
2	4,76 x 1,98 (3/16 x 5/64)	47	2,4 ~ 2,7	13,68 €	13,68 €
3	6,35 x 2,77 (1/4 x 7/64)	50	3,3 ~ 3,9	16,43 €	16,43 €
4	7,93 x 3,17 (5/16 x 1/8)	54	3,8 ~ 4,4	19,15 €	19,15 €
5	11,11 x 4,76 (7/16 x 3/16)	70	5,9 ~ 6,5	36,49 €	36,49 €
6	12,70 x 5,55 (1/2 x 7/32)	76	6,9 ~ 7,5	40,13 €	40,13 €
7	15,87 x 6,35 (5/8 x 1/4)	82	8,0 ~ 8,6	66,27 €	66,27 €
8	19,05 x 7,93 (3/4 x 5/16)	89	10,0 ~ 10,6	83,91 €	83,91 €

BS N°	D x d h7 k12	L ± 1	ℓ mini maxi	magafor 114
1	3,17 x 1,19 (1/8 x 3/64)	38	1,5 ~ 1,8	5,96 €
2	4,76 x 1,58 (3/16 x 1/16)	44	2,0 ~ 2,4	6,20 €
3	6,35 x 2,38 (1/4 x 3/32)	50	3,3 ~ 3,9	7,18 €
4	7,93 x 3,17 (5/16 x 1/8)	56	4,1 ~ 4,7	8,28 €
5	11,11 x 4,76 (7/16 x 3/16)	63	6,5 ~ 7,1	14,89 €
6	15,87 x 6,35 (5/8 x 1/4)	75	8,5 ~ 9,1	25,84 €
7	19,05 x 7,93 (3/4 x 5/16)	89	10,8 ~ 11,6	47,42 €

## Longs

Largas  
Serie lunga



60°-82°-90°

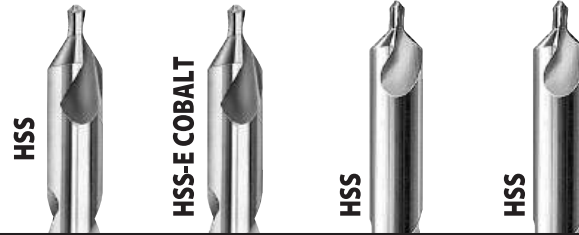

ASA N°	D x d h7 k12	L ± 1	60° 185	60° 186	82° 154-L	90° 155-L
1 x 3"		76	11,31 €	14,14 €	20,06 €	20,06 €
1 x 4"		102	21,28 €	26,61 €	37,69 €	37,69 €
1 x 5"	3,17 x 1,19 (1/8 x 3/64)	127	28,28 €	35,34 €	49,85 €	49,85 €
1 x 6"		152	31,62 €	39,52 €	54,73 €	54,73 €
2 x 3"		76	12,16 €	15,20 €	21,28 €	21,28 €
2 x 4"		102	19,77 €	24,69 €	34,65 €	34,65 €
2 x 5"	4,76 x 1,98 (3/16 x 5/64)	127	27,36 €	34,20 €	48,05 €	48,05 €
2 x 6"		152	31,02 €	38,56 €	55,95 €	55,95 €
3 x 3"		76	12,47 €			
3 x 4"		102	19,77 €	24,69 €	35,27 €	35,27 €
3 x 5"	6,35 x 2,77 (1/4 x 7/64)	127	27,67 €	34,20 €	51,08 €	51,08 €
3 x 6"		152	31,02 €	38,56 €	57,77 €	57,77 €
4 x 3"		76	13,06 €			
4 x 4"		102	20,68 €	25,84 €	36,49 €	36,49 €
4 x 5"	7,93 x 3,17 (5/16 x 1/8)	127	32,23 €	40,28 €	57,77 €	57,77 €
4 x 6"		152	35,87 €	44,85 €	63,24 €	63,24 €
4-1/2 x 4"		102	21,90 €			
4-1/2 x 5"	9,52 x 3,57 (3/8 x 9/64)	127	37,09 €			
4-1/2 x 6"		152	41,95 €	52,44 €	76,01 €	76,01 €
5 x 4"		102	27,67 €	34,58 €	48,64 €	48,64 €
5 x 5"	11,11 x 4,76 (7/16 x 3/16)	127	44,99 €	56,24 €	79,04 €	79,04 €
5 x 6"		152	49,85 €	62,32 €	87,57 €	87,57 €
6 x 4"		102	28,28 €	35,35 €	51,68 €	51,68 €
6 x 5"	12,70 x 5,55 (1/2 x 7/32)	127	45,61 €	57,01 €	82,10 €	82,10 €
6 x 6"		152	51,08 €	63,85 €	91,21 €	91,21 €
7 x 5"	15,87 x 6,35 (5/8 x 1/4)	127	57,77 €			
7 x 6"		152	66,89 €	83,59 €	103,37 €	103,37 €
8 x 6"	19,05 x 7,93 (3/4 x 5/16)	152	74,18 €	92,73 €	133,78 €	133,78 €



Centrage • Pointage / Centering • Spoting  
Centratura • Centrare NC / Centrato • Punteado



# Forets à centrer • Center drills

Brocas de centrar • Punta a centrare

## 60°

## Avec bourrelet de renfort Forme W With reinforcing bulge Form W

Con refuerzo Forma W  
Con refuerzo Forma W

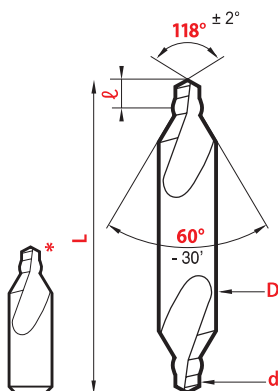
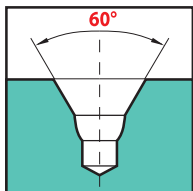

Le foret à centrer **magafor** forme W est plus robuste qu'un foret à centrer normal:

- le bourrelet renforce la pointe,
- il augmente le dégagement des copeaux,
- il favorise la lubrification du foret.

The **magafor** center drill form W is stronger than common center drills:

- the bulge reinforces the point,
- it improves swarf removal,
- it makes the lubrication of the drill easier.

La broca de centrar **magafor** forma W es más robusta que cualquier broca de centrar estándar:

- Punta reforzada,
- Aumento de evacuación de viruta,
- Mejor lubricación de la broca.

La punta a centrare **magafor** forma W è più robusta di una punta a centrare normale:

- il bordino rinforza la punta,
- migliora l'evacuazione dei trucioli,
- favorisce la lubrificazione della punta.

ISO • NFE 66051-W  
DIN 333-W • JIS-1

HSS



D x d	L	ℓ	magafor 14	TIN 0814
h7 k12	± 1	mini maxi		
3,0 x 0,5	31	0,6 ~ 0,9	12,29 €	
3,15 x 0,5*	25	0,6 ~ 0,9	6,08 €	
3,15 x 0,8*	25	1,0 ~ 1,3	6,08 €	
3,15 x 1,0	31	1,3 ~ 1,7	6,08 €	
3,15 x 1,25	31	1,6 ~ 2,0	6,08 €	
4,0 x 1,0	35	1,3 ~ 1,7	6,56 €	12,83 €
4,0 x 1,25	35	1,6 ~ 2,0	6,56 €	
4,0 x 1,6	35	2,0 ~ 2,6	6,56 €	
5,0 x 1,5	40	2,0 ~ 2,6	7,18 €	13,94 €
5,0 x 1,6	40	2,0 ~ 2,6	7,18 €	
5,0 x 2,0	40	2,5 ~ 3,1	7,18 €	
6,0 x 2,0	45	2,5 ~ 3,1	7,90 €	15,20 €
6,3 x 2,0	45	2,5 ~ 3,1	7,90 €	
6,3 x 2,5	45	3,1 ~ 3,8	7,90 €	
8,0 x 2,5	50	3,1 ~ 3,8	8,64 €	16,54 €
8,0 x 3,0	50	3,9 ~ 4,6	8,64 €	
8,0 x 3,15	50	3,9 ~ 4,6	8,64 €	
10,0 x 3,0	55	3,9 ~ 4,6	11,31 €	21,34 €
10,0 x 3,15	55	3,9 ~ 4,6	11,31 €	
10,0 x 4,0	55	5,0 ~ 5,9	11,31 €	
12,0 x 4,0	63	5,0 ~ 5,9	19,15 €	38,31 €
12,0 x 5,0	63	6,3 ~ 7,2	19,15 €	
12,5 x 4,0	63	5,0 ~ 5,9	19,15 €	
12,5 x 5,0	63	6,3 ~ 7,2	19,15 €	
14,0 x 5,0	69	6,3 ~ 7,2	25,54 €	
16,0 x 5,0	71	6,3 ~ 7,2	28,28 €	
16,0 x 6,3	71	8,0 ~ 8,9	28,28 €	
18,0 x 6,0	77	8,0 ~ 8,9	37,09 €	
20,0 x 6,3	80	8,0 ~ 8,9	57,16 €	
20,0 x 8,0	80	10,1 ~ 11,1	57,16 €	
25,0 x 10,0	100	12,8 ~ 13,8	90,00 €	

\*D'un seul côté Single end De una sola punta Ad un solo lato

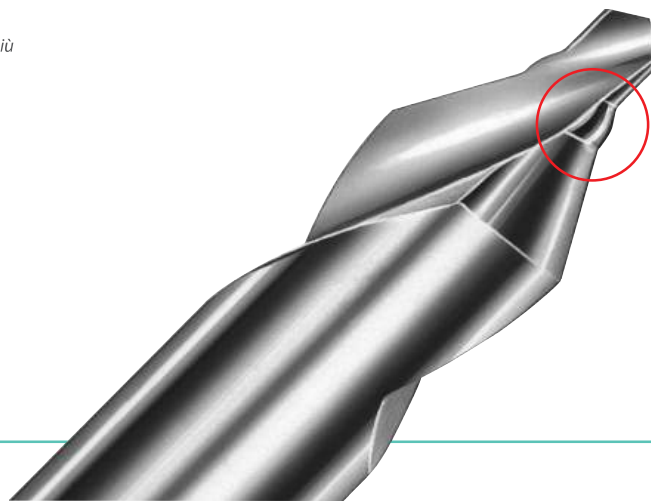



HSS



ASA N°	D x d h7 k12	L ± 1	ℓ mini maxi	magafor 145
1-W	3,17 x 1,19 (1/8 x 3/64)	31	1,4 ~ 1,7	10,94 €
2-W	4,76 x 1,98 (3/16 x 5/64)	47	2,4 ~ 2,7	10,94 €
3-W	6,35 x 2,77 (1/4 x 7/64)	50	3,3 ~ 3,9	10,94 €
4-W	7,93 x 3,17 (5/16 x 1/8)	54	3,8 ~ 4,4	12,47 €
5-W	11,11 x 4,76 (7/16 x 3/16)	70	5,9 ~ 6,5	20,68 €
6-W	12,70 x 5,55 (1/2 x 7/32)	76	6,9 ~ 7,5	23,11 €
7-W	15,87 x 6,35 (5/8 x 1/4)	82	8,0 ~ 8,6	33,44 €
8-W	19,05 x 7,93 (3/4 x 5/16)	89	10,0 ~ 10,6	60,21 €

ISO • NFE 66051-BW  
DIN 333-BW • JIS-1

HSS



D x d h7 k12	L ± 1	K js13	ℓ mini maxi	magafor 023
6,3 x 1,6	45	3,3	2,0 ~ 2,6	12,04 €
8,0 x 2,0	50	4,2	2,5 ~ 3,1	13,85 €
10,0 x 2,5	55	5,3	3,1 ~ 3,8	17,38 €
11,2 x 3,15	62	6,7	3,9 ~ 4,6	25,30 €
14,0 x 4,0	69	8,5	5,0 ~ 5,9	35,87 €
18,0 x 5,0	77	10,6	6,3 ~ 7,2	49,85 €
20,0 x 6,3	80	13,2	8,0 ~ 8,9	69,31 €

## Avec chanfrein et bourrelet de renfort With chamfer and reinforcing bulge

Con chaflan y refuerzo  
Con smusso e bordino di rinforzo

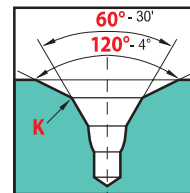

Emballage Packaging  
Embalaje Imballo

**magafor 023-14**

10 pièces piezas pezzi D x d ≤ 10 x 4

**magafor 145**

10 pièces piezas pezzi N° 1W ~ 5W

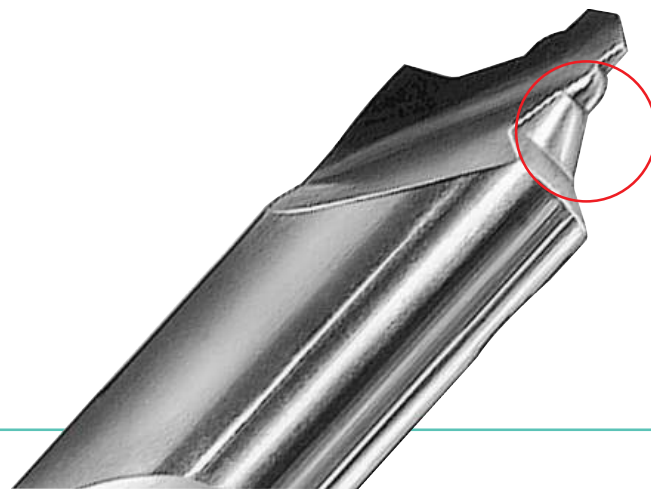

Centrage • Pointage / Centering • Spotting  
Centratura • Centratore NC / Centrato • Punteado





# Forets à centrer • Center drills

Brocas de centrar • Punte a centrare

## À rayon Forme R With radius Form R

Con radio Forma R

A raggio Forma R

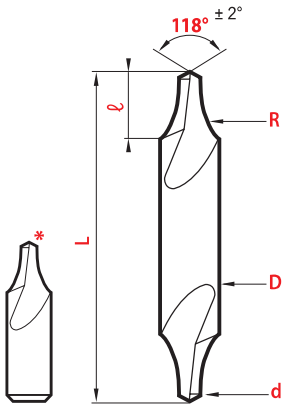
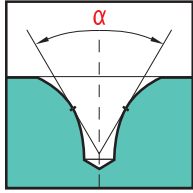

Le foret à centrer à rayon **magafor** par son profil spécial est plus performant que le foret à centrer à 60° :

- le rayon supprime l'amorce de rupture,
- il assure une portée précise de la contre-pointe,
- il fait office de chanfrein de protection.

**Magafor** center drill with radius, thanks to its special profile, is more robust than the 60° center drill :

- the radius eliminates the risk of breakage,
- it provides an exact bearing,
- it serves as a protective chamfer.

La broca de centrar con radio **magafor** gracias a su perfil especial es más robusta que la broca de centrar de 60° :

- El radio suprime el riesgo de rotura,
- Asegura un posicionamiento preciso del contra-punto,
- Hace función de chaflán de protección.

La punta a centrare a raggio **magafor**, grazie alla sua sagoma speciale, è più robusta della punta a centrare a 60° :

- il profilo raggiato elimina i rischi di rottura,
- assicura una spinta costante della contro-punta,
- funge da smusso di protezione. necessità di lavorazione.

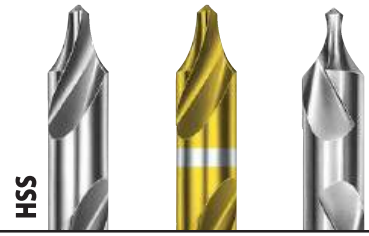

ISO • NFE 66051-R  
DIN 333-R • JIS-1

Type Tipo				HSS	TIN 0812	magafor 170
D x d	L	R	ℓ	magafor 12	TIN 0812	magafor 170
h7 k12	± 1	1,25 R	mini maxi			
3,0 x 0,5	31	2,0	2,3 ~ 2,6	11,80 €		
3,15 x 0,5*	25	2,0	2,3 ~ 2,6	5,71 €		
3,15 x 0,8*	25	2,5	2,6 ~ 2,9	5,71 €		12,16 €
3,15 x 1,0	31	2,9	3,0 ~ 3,3	5,71 €	11,86 €	11,93 €
3,15 x 1,25	31	3,15	3,3 ~ 3,6	5,71 €	11,86 €	11,93 €
3,5 x 0,5	35	3,0	2,7 ~ 3,0	12,16 €		
3,5 x 0,75	35	3,4	2,8 ~ 3,1	6,94 €		
4,0 x 1,0	35	3,9	3,3 ~ 3,6	6,20 €	12,47 €	
4,0 x 1,25	35	4,0	3,7 ~ 4,1	6,20 €		
4,0 x 1,6	35	4,0	4,2 ~ 4,7	5,96 €	12,21 €	11,31 €
5,0 x 1,5	40	5,0	4,5 ~ 4,9	6,94 €	13,68 €	
5,0 x 1,6	40	5,0	4,5 ~ 4,9	6,94 €		
5,0 x 2,0	40	5,0	5,0 ~ 5,4	6,46 €	13,20 €	11,55 €
6,0 x 2,0	45	5,8	5,4 ~ 5,8	7,54 €	14,84 €	
6,3 x 2,0	45	6,3	5,6 ~ 6,0	7,54 €		
6,3 x 2,5	45	6,3	6,3 ~ 6,8	7,18 €	14,48 €	12,04 €
8,0 x 2,5	50	8,0	7,5 ~ 8,0	8,28 €	16,18 €	
8,0 x 3,0	50	8,0	8,0 ~ 8,5	8,28 €	16,18 €	
8,0 x 3,15	50	8,0	8,0 ~ 8,5	8,28 €	16,18 €	14,89 €
10,0 x 3,0	55	10,0	8,9 ~ 9,4	10,82 €	20,62 €	
10,0 x 3,15	55	10,0	8,9 ~ 9,4	10,82 €		
10,0 x 4,0	55	10,0	10,0 ~ 10,6	10,58 €	20,62 €	27,36 €
12,0 x 4,0	63	11,5	10,7 ~ 11,3	18,24 €	38,34 €	
12,0 x 5,0	63	11,5	11,4 ~ 12,0	18,24 €		
12,5 x 4,0	63	12,5	11,2 ~ 11,8	18,24 €		
12,5 x 5,0	63	12,5	12,5 ~ 13,1	17,94 €	36,37 €	39,52 €
14,0 x 5,0	69	13,4	12,8 ~ 13,4	24,02 €		
16,0 x 5,0	71	16,0	14,4 ~ 15,0	27,06 €		
16,0 x 6,3	71	16,0	16,0 ~ 16,6	26,15 €	46,84 €	65,07 €
18,0 x 6,0	77	17,8	16,6 ~ 17,2	38,92 €		
20,0 x 6,3	80	20,0	17,8 ~ 19,0	54,11 €		
20,0 x 8,0	80	20,0	20,0 ~ 20,7	49,25 €		124,04 €
25,0 x 10,0	100	25,0	25,0 ~ 25,7	85,13 €		
31,5 x 12,5	125	31,5	31,5 ~ 32,3	203,10 €		

\*D'un seul côté Single end De una sola punta Ad un solo lato



ISO • NFE 66051-R  
DIN 333-R • JIS-1

D x d	L	R	ℓ	magaforce 8112	Hard'X 8112-H
h5 k12	± 1	1,25 R	mini maxi		
3,15 x 0,5 <sup>(1)</sup>	25	2,0	2,3 ~ 2,6	48,64 €	54,73 €
3,15 x 1,0	31	2,9	3,0 ~ 3,3	51,68 €	58,98 €
3,15 x 1,25	31	3,15	3,3 ~ 3,6	51,68 €	58,98 €
4,0 x 1,6	35	4,0	4,2 ~ 4,7	54,73 €	62,02 €
5,0 x 2,0	40	5,0	5,0 ~ 5,4	66,89 €	76,01 €
6,3 x 2,5	45	6,3	6,3 ~ 6,8	79,04 €	88,17 €
8,0 x 3,15	50	8,0	8,0 ~ 8,5	97,29 €	109,45 €
10,0 x 4,0	55	10,0	10,0 ~ 10,6	127,69 €	142,90 €
12,5 x 5,0	63	12,5	12,5 ~ 13,1	212,83 €	231,07 €

(1) D'un seul côté Single end De una sola punta Ad un solo lato

Centrage • Pointage / Centering • Spotting  
Centratura • Centrare NC / Centrato • Punteado

# Avec plat

With flat

Con plano

Con piano

ISO • NFE 66051-R

DIN 333-R • JIS-1

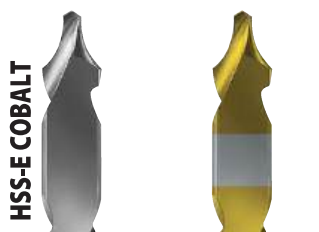
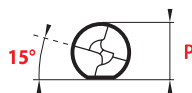

performances  
➤ p. 17

D x d	L	R	ℓ		P	magafor 0291	TIN 0891
h7 k12	± 1	1,25 R	mini	maxi	-0,1		
4,0 x 1,6	35	4,0	4,2	~ 4,7	3,25	9,23 €	14,48 €
5,0 x 2,0	40	5,0	5,0	~ 5,4	4,20	10,34 €	16,05 €
6,3 x 2,5	45	6,3	6,3	~ 6,8	5,35	11,31 €	17,87 €
8,0 x 3,15	50	8,0	8,0	~ 8,5	6,95	13,68 €	20,36 €
10,0 x 4,0	55	10,0	10,0	~ 10,6	8,40	21,40 €	31,02 €
12,5 x 5,0	63	12,5	12,5	~ 13,1	10,95	29,18 €	47,42 €
16,0 x 6,3	71	16,0	16,0	~ 16,6	14,00	47,42 €	66,27 €
20,0 x 8,0	80	20,0	20,0	~ 20,7	17,90	74,79 €	

# Longs

Largas

Serie lunga

magafor standard



L	D x d	R	ℓ		magafor 187
± 1	h7 k12	1,25 R	mini	maxi	
<b>120</b>	4,0 x 1,0	3,9	3,3	~ 3,6	53,51 €
	5,0 x 1,5	5,0	4,5	~ 4,9	52,29 €
	6,0 x 2,0	5,8	5,4	~ 5,8	52,29 €
	8,0 x 2,5	8,0	7,5	~ 8,0	60,80 €
	10,0 x 3,0	10,0	8,9	~ 9,4	69,31 €
	10,0 x 4,0	10,0	10,0	~ 10,6	69,31 €



ASA N°	D x d	L	R	ℓ		magafor 125
	h7 k12	± 1	1,25 R	mini	maxi	
<b>1 - R</b>	3,17 x 1,19 (1/8 x 3/64)	31	3,9	3,3	~ 3,7	6,34 €
<b>2 - R</b>	4,76 x 1,98 (3/16 x 5/64)	47	5,8	5,2	~ 5,6	7,04 €
<b>3 - R</b>	6,35 x 2,77 (1/4 x 7/64)	50	8,0	7,0	~ 7,5	7,85 €
<b>4 - R</b>	7,93 x 3,17 (5/16 x 1/8)	54	10,0	8,7	~ 9,3	9,14 €
<b>5 - R</b>	11,11 x 4,76 (7/16 x 3/16)	70	12,5	12,3	~ 12,9	17,76 €
<b>6 - R</b>	12,70 x 5,55 (1/2 x 7/32)	76	13,4	13,4	~ 14,5	19,91 €
<b>7 - R</b>	15,87 x 6,35 (5/8 x 1/4)	82	17,8	17,0	~ 17,7	29,97 €
<b>8 - R</b>	19,05 x 7,93 (3/4 x 5/16)	89	20,0	20,6	~ 21,4	55,28 €



Emballage Packaging

Embalaje Imballo

magafor 12-125

10 pièces piezas pezzi D x d ≤ 10 x 4 / 5R



Centrage • Pointage / Centering • Spotting  
Centratura • Centrare NC / Centrato • Punteado



# Forets à centrer • Center drills

Brocas de centrar • Punte a centrare

## Avec chanfrein de protection Form B With protective angle Form B

Con chaflán de protección Forma B  
Con smusso di protezione Forma B

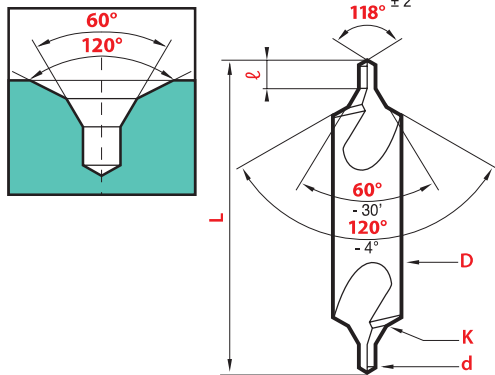

Le foret à centrer avec chanfrein de protection garantit le centre obtenu contre tout risque de choc et de déformation. L'évasement résultant du chanfrein de protection facilite la prise entre pointes des pièces sur machine à alimentation automatique.

Center drill with protective chamfer protects the center obtained from any risk of blows and deformation. The splay resulting from the protective chamfer makes it easier to load parts between centers on machine with automatic feed.

Las brocas de centrar con chaflán de protección garantizan el centrado obtenido contra todo riesgo de choque y deformación. La abertura resultante del chaflán de protección facilita la unión entre puntos de las piezas sobre máquinas de alimentación automática.

La punta a centrare con smusso di protezione garantisce il centro ottenuto contro ogni rischio di urti e di deformazioni. La svasatura risultante dallo smusso di protezione facilita la presa dei pezzi fra le punte su macchine con caricamento automatico.

ISO • NFE 66051-B  
DIN 333-B • JIS-2

HSS

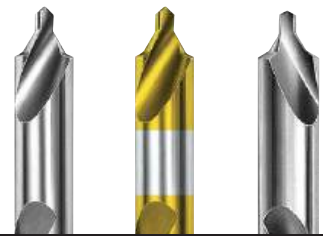

Type  
Tipo

D x d h7 k12	L ± 1	K js13	ℓ		magafor 13	TIN 0813	magafor 173
			mini	maxi			
3,0 x 0,5	31	1,2	0,6 ~ 0,9		13,85 €		
4,0 x 0,75	35	2,0	1,0 ~ 1,3		12,04 €		
4,0 x 1,0	35	2,1	1,3 ~ 1,7		9,85 €	16,12 €	20,98 €
5,0 x 1,25	40	2,6	1,6 ~ 2,0		9,85 €	16,60 €	22,19 €
5,0 x 1,5*	40	3,0	2,0 ~ 2,6		11,31 €		
6,0 x 1,0	45	2,5	1,3 ~ 1,7		12,77 €		
6,0 x 2,0*	45	4,0	2,5 ~ 3,1		12,77 €	20,12 €	
6,3 x 1,6	45	3,3	2,0 ~ 2,6		10,09 €	17,38 €	25,84 €
8,0 x 1,5	50	3,8	2,0 ~ 2,6		14,60 €		
8,0 x 2,0	50	4,2	2,5 ~ 3,1		11,80 €	19,69 €	29,18 €
8,0 x 2,5*	50	5,5	3,1 ~ 3,8		14,60 €		
8,0 x 3,0*	50	6,0	3,9 ~ 4,6		14,60 €	22,49 €	
10,0 x 2,0	55	5,0	2,5 ~ 3,1		17,63 €		
10,0 x 2,5	55	5,3	3,1 ~ 3,8		14,89 €	25,24 €	31,02 €
10,0 x 3,0*	55	7,0	3,9 ~ 4,6		17,63 €		
10,0 x 4,0*	55	8,0	5,0 ~ 5,9		17,63 €	28,01 €	
11,2 x 3,15	62	6,7	3,9 ~ 4,6		21,28 €	38,62 €	36,49 €
12,0 x 2,5	63	6,3	3,1 ~ 3,8		26,46 €		
12,0 x 4,0*	63	9,0	5,0 ~ 5,9		24,62 €	41,98 €	
12,0 x 5,0*	63	9,0	6,3 ~ 7,2		24,62 €		
14,0 x 3,0	69	7,5	3,9 ~ 4,6		33,44 €		
14,0 x 4,0	69	8,5	5,0 ~ 5,9		29,49 €	52,90 €	48,64 €
14,0 x 5,0*	69	10,0	6,3 ~ 7,2		33,44 €	56,81 €	
16,0 x 4,0	71	10,0	5,0 ~ 5,9		42,56 €		
18,0 x 4,0	77	10,0	5,0 ~ 5,9		46,22 €		
18,0 x 5,0	77	10,6	6,3 ~ 7,2		42,56 €	63,85 €	61,42 €
18,0 x 6,0*	77	12,0	8,0 ~ 8,9		46,22 €		
20,0 x 5,0	80	12,5	6,3 ~ 7,2		75,40 €		
20,0 x 6,3	80	13,2	8,0 ~ 8,9		58,37 €	84,52 €	81,48 €
25,0 x 6,0	100	15,0	8,0 ~ 8,9		113,72 €		
25,0 x 6,3	100	16,0	8,0 ~ 8,9		113,72 €		
25,0 x 8,0	100	17,0	10,1 ~ 11,1		96,69 €		
31,5 x 10,0	125	21,2	12,8 ~ 13,8		217,69 €		

\*Dimensions recommandées = pointes fortes Suggested sizes = strong points  
Dimensiones recomendadas = punta reforzada Misure consigliate = punte robuste

## Avec bourrelet de renfort With reinforced bulge

Con chaflán y refuerzo  
Con bordino di rinforzo

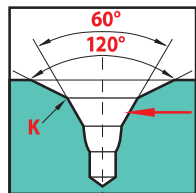

ISO • NFE 66051-BW  
DIN 333-BW • JIS-2

HSS



D x d h7 k12	L ± 1	K js13	ℓ		magafor 023
			mini	maxi	
6,3 x 1,6	45	3,3	2,0 ~ 2,6		12,04 €
8,0 x 2,0	50	4,2	2,5 ~ 3,1		13,85 €
10,0 x 2,5	55	5,3	3,1 ~ 3,8		17,38 €
11,2 x 3,15	62	6,7	3,9 ~ 4,6		25,30 €
14,0 x 4,0	69	8,5	5,0 ~ 5,9		35,87 €
18,0 x 5,0	77	10,6	6,3 ~ 7,2		49,85 €
20,0 x 6,3	80	13,2	8,0 ~ 8,9		69,31 €



# Avec plat

With flat

Con plano

Con piano

ISO • NFE 66051-B  
DIN 333-B • JIS-2

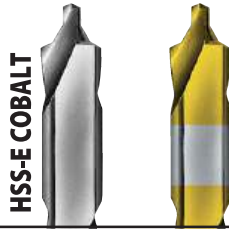
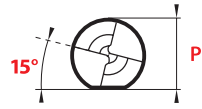

Dxd	L	K	ℓ		P	magafor	TIN
h7 k12	±1	js13	mini	maxi	-0,1	0292	0892
6,3 x 1,6	45	3,3	2,0	~ 2,6	5,35	14,11 €	21,40 €
8,0 x 2,0	50	4,2	2,5	~ 3,1	6,95	17,02 €	24,93 €
10,0 x 2,5	55	5,3	3,1	~ 3,8	8,40	23,60 €	35,15 €
11,2 x 3,15	63	6,7	3,9	~ 4,6	10,00	31,62 €	49,25 €
14,0 x 4,0	69	8,5	5,0	~ 5,9	12,65	41,95 €	62,64 €
18,0 x 5,0	77	10,6	6,3	~ 7,2	16,40	63,85 €	88,17 €
20,0 x 6,3	80	13,2	8,0	~ 8,9	17,90	82,70 €	108,85 €
25,0 x 8,0	100	17,0	10,1	~ 11,1	22,50	159,31 €	
31,5 x 10,0	125	21,2	12,8	~ 13,8	28,40	265,12 €	

# Longs

Largas

Serie lunga

magafor standard



L	Dxd	K	ℓ		magafor
±1	h7 k12	js13	mini	maxi	189
<b>120</b>	4,0 x 1,0	2,1	1,3	~ 1,7	81,48 €
	5,0 x 1,5	3,0	2,0	~ 2,6	76,61 €
	6,0 x 2,0	4,0	2,5	~ 3,1	76,61 €
	8,0 x 2,5	5,5	3,1	~ 3,8	90,00 €
	10,0 x 3,0	7,0	3,9	~ 4,6	104,59 €



Emballage Packaging

Embalaje Imballo

**magafor 13 - 023**

10 pièces piezas pezzi D x d ≤ 10 x 4

**magafor 134 - 135**

10 pièces piezas pezzi N° 1B ~ 5B + N° 11 ~ 15



HSS

BS N°	Dxd	L	K	ℓ		magafor
	h7 k12	±1	js13	mini	maxi	134
1-B	3,17 x 1,19 (1/8 x 3/64)	38	1,9	1,6	~ 2,0	11,31 €
2-B	4,76 x 1,58 (3/16 x 1/16)	45	2,8	2,0	~ 2,4	11,31 €
3-B	6,35 x 2,38 (1/4 x 3/32)	50	3,8	3,3	~ 3,9	11,31 €
4-B	7,93 x 2,77 (5/16 x 7/64)	56	4,8	4,1	~ 4,7	12,77 €
5-B	11,11 x 3,96 (7/16 x 5/32)	64	6,6	5,7	~ 6,3	21,59 €
6-B	15,87 x 5,55 (5/8 x 7/32)	76	9,5	7,7	~ 8,3	35,27 €
7-B	19,05 x 6,35 (3/4 x 1/4)	88	11,4	9,2	~ 10,0	62,02 €



HSS

ASA N°	Dxd	L	K	ℓ		magafor
	h7 k12	±1	js13	mini	maxi	135
11	3,17 x 1,19 (1/8 x 3/64)	31	2,5	1,4	~ 1,7	11,31 €
12	4,76 x 1,58 (3/16 x 1/16)	47	3,8	1,9	~ 2,2	11,31 €
13	6,35 x 2,38 (1/4 x 3/32)	50	5,1	2,8	~ 3,4	11,31 €
14	7,93 x 2,77 (5/16 x 7/64)	54	6,3	3,3	~ 3,9	12,77 €
15	11,11 x 3,96 (7/16 x 5/32)	70	8,9	4,8	~ 5,4	21,59 €
16	12,70 x 4,76 (1/2 x 3/16)	76	10,1	5,9	~ 6,5	24,02 €
17	15,87 x 5,55 (5/8 x 7/32)	82	12,7	6,9	~ 7,5	35,27 €
18	19,05 x 6,35 (3/4 x 1/4)	89	15,2	8,0	~ 8,6	62,02 €
19	22,22 x 7,93 (7/8 x 5/16)	92	17,8	10,0	~ 10,6	74,79 €
20	25,40 x 9,52 (1 x 3/8)	95	20,3	12,1	~ 12,7	106,41 €



Centrage • Pointage / Centering • Spotting  
Centratura • Centrare NC / Centrato • Punteado



# Forets à centrer • Center drills

Brocas de centrar • Punte a centrare

90°

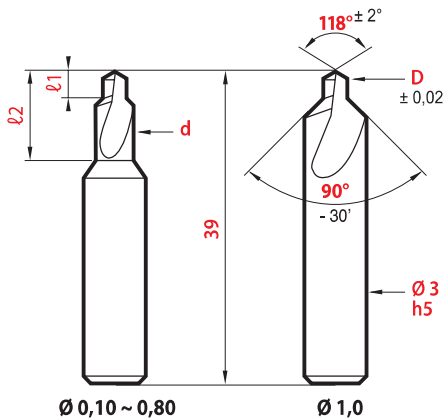
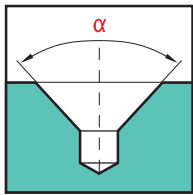

CARBURE CARBIDE  
Metallo duro



D	d	l1	l2	magaforce 82X-1
	mini	mini		
0,10	0,55	0,10	1,8	39,52 €
0,15	0,55	0,15	1,8	38,92 €
0,20	0,55	0,20	1,8	38,31 €
0,25	0,85	0,25	2,7	37,69 €
0,30	0,85	0,30	2,7	36,49 €
0,40	1,4	0,40	4,5	35,27 €
0,50	1,4	0,50	4,5	35,27 €
0,60	2,3	0,60	7,2	35,27 €
0,80	2,3	0,80	7,2	35,27 €
1,00	-	1,00	-	35,27 €



Type  
Tipo

D x d	L	l	magafor 15	magafor 175	magaforce 8115	Hard'X 8115-H
<b>h7<sup>(1)</sup> k12</b>	<b>± 1</b>	mini maxi				
3,0 x 0,5 <sup>(2)</sup>	25	0,6 ~ 0,9	15,50 €			
3,5 x 0,75	35	1,0 ~ 1,3	13,99 €			
4,0 x 1,0	35	1,3 ~ 1,7	12,77 €	40,75 €	69,00 €	76,01 €
5,0 x 1,5	40	2,0 ~ 2,6	13,06 €	43,78 €		
6,0 x 2,0	45	2,5 ~ 3,1	16,12 €	46,22 €	96,00 €	106,41 €
8,0 x 2,5	50	3,1 ~ 3,8	18,55 €	49,25 €		
8,0 x 3,0	50	3,9 ~ 4,6	18,55 €	49,25 €	118,00 €	130,74 €
10,0 x 3,0	55	3,9 ~ 4,6	24,02 €	56,55 €		
10,0 x 4,0	55	5,0 ~ 5,9	24,02 €	56,55 €	156,00 €	170,27 €
12,0 x 4,0	63	5,0 ~ 5,9	36,49 €			
12,0 x 5,0	63	6,3 ~ 7,2	36,49 €			
14,0 x 5,0	69	6,3 ~ 7,2	50,47 €			
18,0 x 6,0	77	8,0 ~ 8,9	74,18 €			
25,0 x 8,0	100	10,1 ~ 11,1	159,31 €			

(1) CARBURE CARBIDE METAL DURO METALLO DURO = h5

(2) D'un seul côté Single end De una sola punta Ad un solo lato

## Longs

Largas  
Serie lunga

D x d	L	l	magafor 188
<b>h7 k12</b>	<b>± 1</b>	mini maxi	
4,0 x 1,0	120	1,3 ~ 1,7	81,48 €
5,0 x 1,5	120	2,0 ~ 2,6	76,61 €
6,0 x 2,0	120	2,5 ~ 3,1	76,61 €
8,0 x 2,5	120	3,1 ~ 3,8	84,08 €
10,0 x 3,0	120	3,9 ~ 4,6	92,95 €
10,0 x 4,0	120	5,0 ~ 5,9	92,95 €

HSS-E COBALT



Centrage • Pointage / Centering • Spotting

Centratura • Centrare NC / Centrato • Punteado

# Special

**2 semaines • 2 weeks**  
2 semanas • 2 settimane

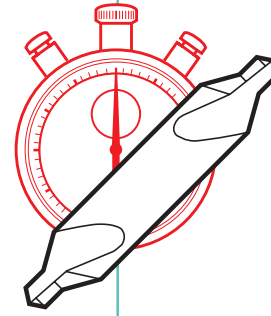
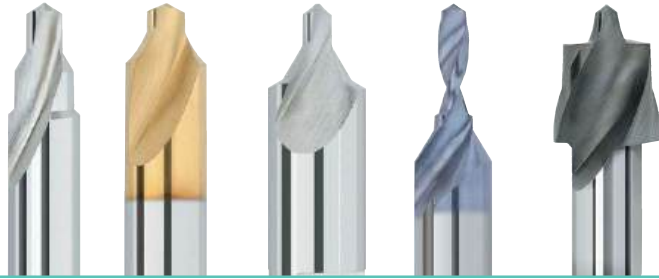

Nous disposons d'ébauches qui permettent de réaliser nombre d'outils spéciaux : consultez-nous en complétant le croquis correspondant à votre centrage.

Our stock of semi-finished tools enables us to manufacture many specials : with your inquiries please complete the appropriate sketch with your centering operation.

Nuestro stock de herramientas semi-elaboradas nos permite la fabricación de numerosas herramientas especiales con sus peticiones rellene el croquis adecuado a sus necesidades.

Disponiamo di sbazzati che ci consentono di costruire numerosi utensili speciali : consultateci completando il disegno corrispondente alla vostra necessità.

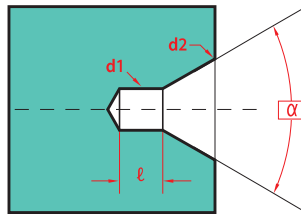

d1 =      l =  
d2 =      alpha =

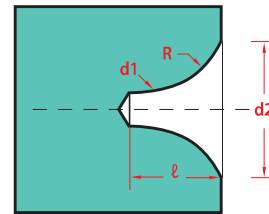

d1 =      R =  
d2 =      l =

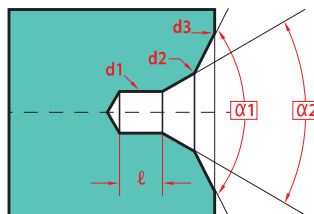

d1 =      l =  
d2 =      alpha1 =  
d3 =      alpha2 =

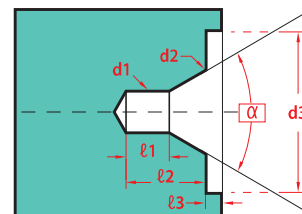

d1 =      l1 =  
d2 =      l2 =  
d3 =      l3 =  
alpha =

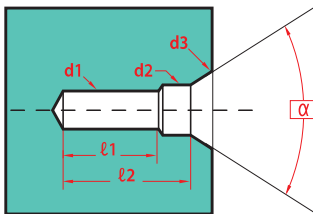

d1 =      l1 =  
d2 =      l2 =  
d3 =      alpha =

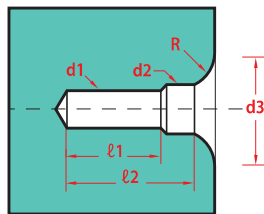

d1 =      R =  
d2 =      l1 =  
d3 =      l2 =

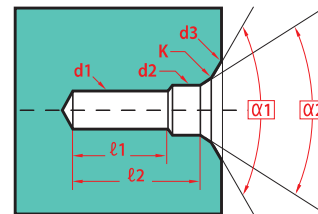

d1 =      K =  
d2 =      l1 =  
d3 =      l2 =  
alpha =      l3 =  
            alpha2 =

Matière à usiner / Material to machine  
Material a mecanizar / Materiale da lavorare \_\_\_\_\_

Quantité d'outils / Number of tools  
Número de herramientas / Numero pezzi \_\_\_\_\_

Tolérance spéciale / Special tolerance  
Tolerancia especial / Tolleranza speciale \_\_\_\_\_

Nom et adresse / Name and address  
Nombre y dirección / Nome ed indirizzo





# Forets à centrer • Center drills

Brocas de centrar • Punte a centrare

## Les bouts d'arbres filetés

### For threaded holes

Para los extremos de ejes roscados

Per le estremità di alberi filettati

**Principale utilisation :**  
pour centrer et percer les axes de moteurs électriques, pompes et moto-réducteurs.

Ces forets à centrer sont conçus pour réaliser en une seule opération :

- 1 - l'avant-trou de taraudage,
- 2 - l'entrée de taraud,
- 3 - le centre.

Les codes **0280 - 0288 - 0284** ont un plat de serrage et pour le logement d'un outil de dressage. Les deux rainures latérales facilitent la lubrification.

**Main use :**  
to center and to bore the shafts of electric motors, pumps and speed-reducing gear.

These Center drills are designed to do the following in a single operation :

- 1 - make the preliminary tap hole,
- 2 - make the tap entrance,
- 3 - do the centering.

The code **0280 - 0288 - 0284** have a flat for a blocking screw and carbide insert. The two side grooves facilitate lubrication.

*Usa principal :*  
Centrado y taladrado de ejes de motores eléctricos, bombas, motoreductores.

*Estas brocas de centrar están diseñadas para realizar en una sola operación :*

- 1 - el agujero previo de roscado,
- 2 - la entrada de rosca,
- 3 - el centrado.

*El código 0280 - 0288 - 0284 incorporan un plano de bloqueo para el tornillo de apriete y la placa de metal duro. Las dos ranuras laterales facilitan la lubricación.*

*Principale impiego :*  
per centrare e forare gli assi di motori elettrici, pompe e moto-riduttori.

*Queste punte a centrare sono concepite per realizzare in un'unica operazione :*

- 1 - l'avanzamento di filettatura,
- 2 - l'imboccatura per il maschio,
- 3 - la centratura.

*Gli articoli 0280 - 0288 - 0284 presentano un piano di bloccaggio anche per il posizionamento all'interno di una macchina intestatrice. Le due scanalature laterali favoriscono la lubrificazione.*

### Forme D

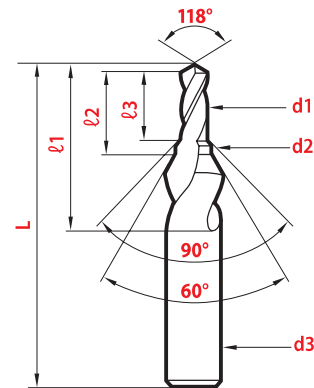
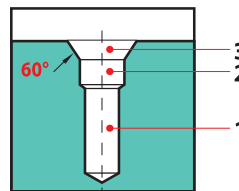

### Forme DR

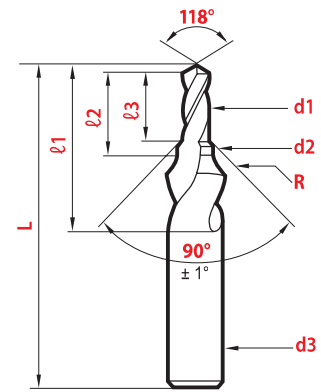
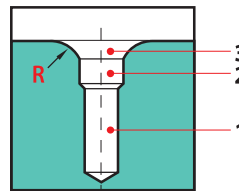

### Forme DS

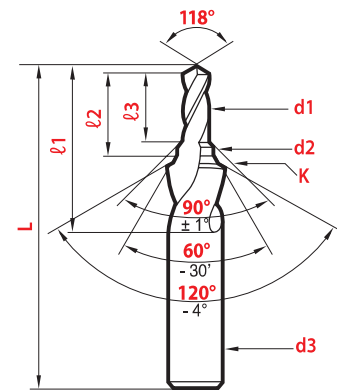
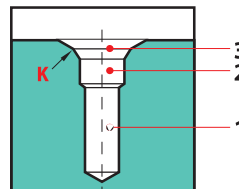



## DIN 332/2 - Forme D

Sans plat  
Without flat  
Sin plano  
Senza piano



Avec plat  
With flat  
Con plano  
Con piano

VIS VITE Kernloch	d1 -0/-0,05	d2 ± 0,5	d3 h7	L ± 1	ℓ1	ℓ2	ℓ3	magafor 0285	Red'X 0985	P -0,1	magafor 0280
M3	2,5	3,2	6,0	55	18	9,0	8	54,73 €	61,70 €		
M4	3,3	4,3	8,0	63	23	12,6	11	48,64 €	59,12 €	6,75	66,89 €
M5	4,2	5,3	10,0	67	27	15,1	13	57,77 €	70,57 €	8,45	72,97 €
M6	5,0	6,4	12,5	71	33	18,9	16	66,89 €	83,10 €	10,45	91,21 €
M8	6,8	8,4	14,0	88	41	23,0	19	72,97 €	91,06 €	12,50	97,29 €
M10	8,5	10,5	16,0	90	47	27,7	23	85,13 €	109,77 €	14,85	109,45 €
M12	10,2	13,0	20,0	105	59	34,5	28	103,37 €	139,04 €	18,45	133,78 €
M16	14,0	17,0	25,0	132	67	41,3	33			23,45	255,39 €
M20	17,5	21,0	31,5	145	77	48,3	38			29,35	352,68 €
M24	21,0	25,0	40,0	160	90	57,0	45			36,50	547,27 €

## DIN 332/2 - FORME DR

Sans plat  
Without flat  
Sin plano  
Senza piano



Avec plat  
With flat  
Con plano  
Con piano

VIS VITE Kernloch	d1 -0/-0,05	d2 ± 0,5	d3 h7	L ± 1	ℓ1	ℓ2	ℓ3	R*	magafor 0287	P -0,1	magafor 0288
M4	3,3	4,3	8,0	63	23	12,6	11	4	57,77 €	6,75	79,04 €
M5	4,2	5,3	10,0	67	27	15,1	13	6	66,89 €	8,45	85,13 €
M6	5,0	6,4	12,5	71	33	18,9	16	8	79,04 €	10,45	103,37 €
M8	6,8	8,4	14,0	88	41	23,0	19	10	88,17 €	12,50	112,50 €
M10	8,5	10,5	16,0	90	47	27,7	23	16	100,33 €	14,85	124,66 €
M12	10,2	13,0	20,0	105	59	34,5	28	20	121,62 €	18,45	155,06 €
M16	14,0	17,0	25,0	132	70	41,3	33	25		23,40	291,87 €
M20	17,5	21,0	31,5	145	77	48,3	38	31,5		29,35	425,65 €
M24	21,0	25,0	40,0	160	98	57	45	40		36,50	626,31 €

\*R maxi = 1,25 R

## DIN 332/2 - FORME DS

Sans plat  
Without flat  
Sin plano  
Senza piano



Avec plat  
With flat  
Con plano  
Con piano

VIS VITE Kernloch	d1 -0/-0,05	d2 ± 0,5	d3 h7	L ± 1	ℓ1	ℓ2	ℓ3	K js13	magafor 0283	P -0,1	magafor 0284
M4	3,3	4,3	8	63	23	12,6	11	6,4	57,77 €	6,75	79,04 €
M5	4,2	5,3	10	67	27	15,1	13	7,8	66,89 €	8,45	85,13 €
M6	5,0	6,4	12,5	71	33	18,9	16	9,1	79,04 €	10,45	103,37 €
M8	6,8	8,4	14,0	88	41	23,0	19	11,8	88,17 €	12,50	112,50 €
M10	8,5	10,5	18,0	90	47	27,7	23	14,2	100,33 €	14,85	124,66 €
M12	10,2	13,0	20,0	105	59	34,5	28	17,4	121,62 €	18,45	155,06 €
M16	14,0	17,0	26,0	132	70	41,3	33	21,9		23,40	291,87 €



**Revêtements : nous consulter.**

**Coating : please inquire**

*Recubrimiento : sobre pedido*

*Rivestimento : consultateci*