

### ALUMINIUM PROFILE PRODUCT



มือจับอลูมิเนียม ตัวซี สำหรับไม้หนา 16 มิล และ 19 มิล  
( C SAHAPE ) 16 mm. and 19 mm.

Material : Aluminium  
Wood Thickness : 16 mm.

ITEM NO	DESCRIPTION
PROAL-3516-3	มือจับอลูมิเนียมตัว C ยาว 3 เมตร
PROAL-3516AND	มือจับอลูมิเนียมตัว C ยาว 6 เมตร

Material : Aluminium  
Wood Thickness : 19 mm.

ITEM NO	DESCRIPTION
PROAL-1935-3	มือจับอลูมิเนียมตัว C ยาว 3 เมตร
PROAL-1935-6	มือจับอลูมิเนียมตัว C ยาว 6 เมตร

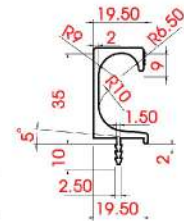
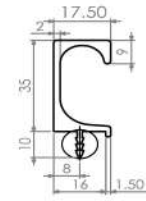

มือจับอลูมิเนียม แบบเฉียง สำหรับไม้หนา 16 มิล และ 19 มิล  
ALUMINIUM PROFILE 16 mm. and 19 mm.

Material : Aluminium  
Wood Thickness : 16 mm.

ITEM NO	DESCRIPTION
PROAL-3816-3	มือจับอลูมิเนียมแบบเฉียง ยาว 3 เมตร
PROAL-3816AND	มือจับอลูมิเนียมแบบเฉียง ยาว 6 เมตร

Material : Aluminium  
Wood Thickness : 19 mm.

ITEM NO	DESCRIPTION
PROAL-3519-3	มือจับอลูมิเนียมแบบเฉียง ยาว 3 เมตร
PROAL-3519-6	มือจับอลูมิเนียมแบบเฉียง ยาว 6 เมตร

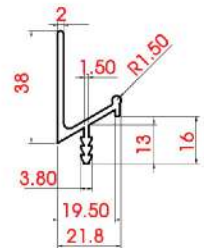
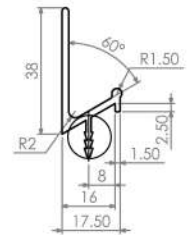

มือจับอลูมิเนียม ตัวยู สำหรับไม้หนา 16 มิล และ 19 มิล  
ALUMINIUM PROFILE ( U SAHAPE ) 16 mm. and 19 mm.

Material : Aluminium  
Wood Thickness : 16 mm.

ITEM NO	DESCRIPTION
PROAL-2116-3	มือจับอลูมิเนียมตัวยู ยาว 3 เมตร
PROAL-2116AND	มือจับอลูมิเนียมตัวยู ยาว 6 เมตร

Material : Aluminium  
Wood Thickness : 19 mm.

ITEM NO	DESCRIPTION
PROAL-3119-3	มือจับอลูมิเนียมตัวยู ยาว 3 เมตร
PROAL-3119-6	มือจับอลูมิเนียมตัวยู ยาว 6 เมตร

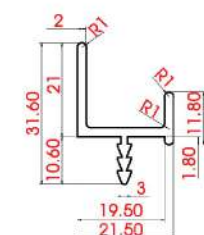
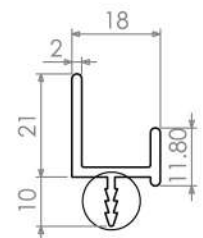

มือจับอลูมิเนียม แบบคางหมู สำหรับไม้หนา 19 มม  
ALUMINIUM PROFILE ( TRAPEZOID ) 19 mm.

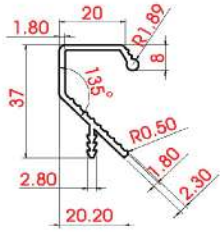

Material : Aluminium  
Wood Thickness : 19 mm.

ITEM NO	DESCRIPTION
PROAL-3720-3	มือจับอลูมิเนียมแบบคางหมู ยาว 3 เมตร
PROAL-3720-6	มือจับอลูมิเนียมแบบคางหมู ยาว 6 เมตร

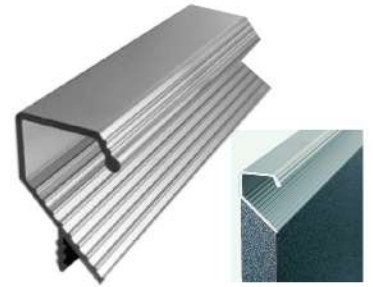

มือจับอลูมิเนียม แบบตัว ยูเอียง  
ALUMINIUM PROFILE

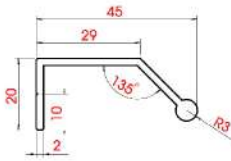

Material : Aluminium

ITEM NO	DESCRIPTION
PROAL-4519-3	มือจับอลูมิเนียมแบบตัวยู ยาว 3 เมตร
PROAL-4519-6	มือจับอลูมิเนียมแบบตัวยู ยาว 6 เมตร



มือจับอลูมิเนียม แบบตัว เอฟ  
ALUMINIUM PROFILE

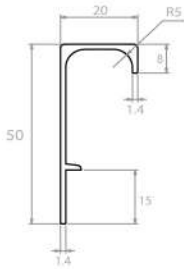

Material : Aluminium

ITEM NO	DESCRIPTION
HDAL-2050AND	มือจับอลูมิเนียมแบบตัวเอฟ ยาว 6 เมตร



มือจับอลูมิเนียมตัวยูเอียง แบบมีร่องชนแปรงขน  
ALUMINIUM HANDLES

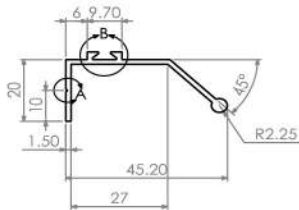

ตัวมือจับอลูมิเนียมรุ่นนี้ เพิ่มตัวร่องชนแปรงขนมาด้านบน  
ช่วยในการกันฝุ่นต่าง ๆ ที่จะเข้าไปดูของถ่าน

Material : Aluminium

ITEM NO	DESCRIPTION
PROAL-4660	มือจับอลูมิเนียมตัวยูเอียง ยาว 6 เมตร มีร่องชนแปรงขน



มือจับอลูมิเนียมตัวยูเอียง แบบมีร่องชนแปรงล่าง  
ALUMINIUM HANDLES

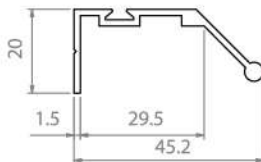

Material : Aluminium

ITEM NO	DESCRIPTION
PROAL-4662	มือจับอลูมิเนียมตัวยูเอียง ยาว 6 เมตร มีร่องชนแปรงล่าง



สีกทาลานขนเสี้ยนกับฟุ้งสีทา  
DUST COVER BRUSH

Material : Plastic(พลาสติก)

ITEM NO	SIZE
ABPL-05400GR	400 M





## ALUMINIUM PROFILE PRODUCT



มือจับอลูมิเนียม แบบตัว แอล  
ALUMINIUM PROFILE

Material : Aluminium

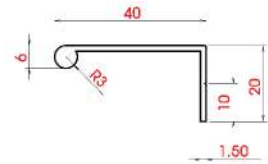

ITEM NO	DESCRIPTION
PROAL-2040-3	มือจับอลูมิเนียมแบบตัวแอล ยาว 3 เมตร
PROAL-2040-6	มือจับอลูมิเนียมแบบตัวแอล ยาว 6 เมตร



มือจับอลูมิเนียม แบบตัว แอล รุ่นตัดสำเร็จพร้อมเจาะรูสกรู  
ALUMINIUM PROFILE

Material : Aluminium

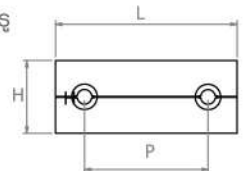

มือจับอลูมิเนียมสีทอง

ITEM NO	L	P	H
PROAL-2040-40G	40 mm.	32 mm.	20 mm.
PROAL-2040-80G	80 mm.	64 mm.	20 mm.
PROAL-2040-120G	120 mm.	96 mm.	20 mm.
PROAL-2040-160G	160 mm.	120 mm.	20 mm.
PROAL-2040-200G	200 mm.	160 mm.	20 mm.



มือจับอลูมิเนียมสีดำ

ITEM NO	L	P	H
PROAL-2040-40MB	40 mm.	32 mm.	20 mm.
PROAL-2040-80MB	80 mm.	64 mm.	20 mm.
PROAL-2040-120MB	120 mm.	96 mm.	20 mm.
PROAL-2040-160MB	160 mm.	120 mm.	20 mm.
PROAL-2040-200MB	200 mm.	160 mm.	20 mm.

สีงพลิตสีอื่นสามารถติดต่อที่พนักงานขาย

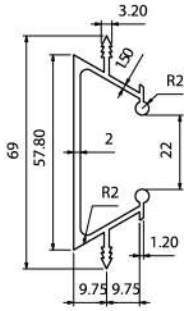

มือจับอลูมิเนียม โพรไฟล์  
ALUMINIUM HANDLES PROFILE

Material : Aluminium

ITEM NO	LENGTH
PROAL-H-03-3	3 M.

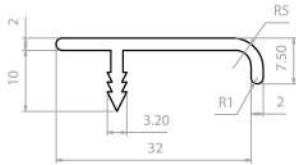

มือจับอลูมิเนียม โพรไฟล์  
ALUMINIUM HANDLES PROFILE

Material : Aluminium

ITEM NO	LENGTH
PROAL-H-04-3	3 M.

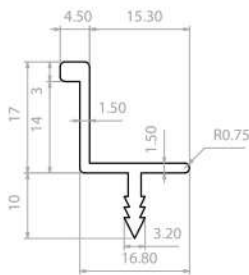

มือจับอลูมิเนียม โพรไฟล์  
ALUMINIUM HANDLES PROFILE

Material : Aluminium

ITEM NO	LENGTH
PROAL-H-05-3	3 M.

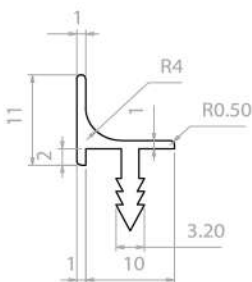

มือจับอลูมิเนียม โพรไฟล์  
ALUMINIUM HANDLES PROFILE

Material : Aluminium

ITEM NO	LENGTH
PROAL-H-06-3	3 M.

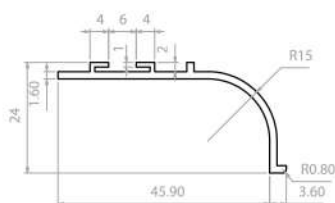

มือจับอลูมิเนียม แฮนด์ไลน์  
ALUMINIUM HANDLES PROFILE

Material : Aluminium

ITEM NO	LENGTH
PROAL-H-07-3	3 M.





## มือจับโปรไฟล์มิลลิ่ง Slot Milling Handle

การมิลลิ่ง (Milling) เป็นการกัดวัสดุด้วยใบมีด โดยการกัดโค้ง กัดน้ํา กัดร่อง กัดตรง รวมถึงสร้างผิวเรียบบนชิ้นงาน ซึ่งสามารถนำมาใช้กับงานมือจับอลูมิเนียมได้ เป็นการเพิ่มความสวยงามของมือจับให้ทันสมัยได้มากขึ้น

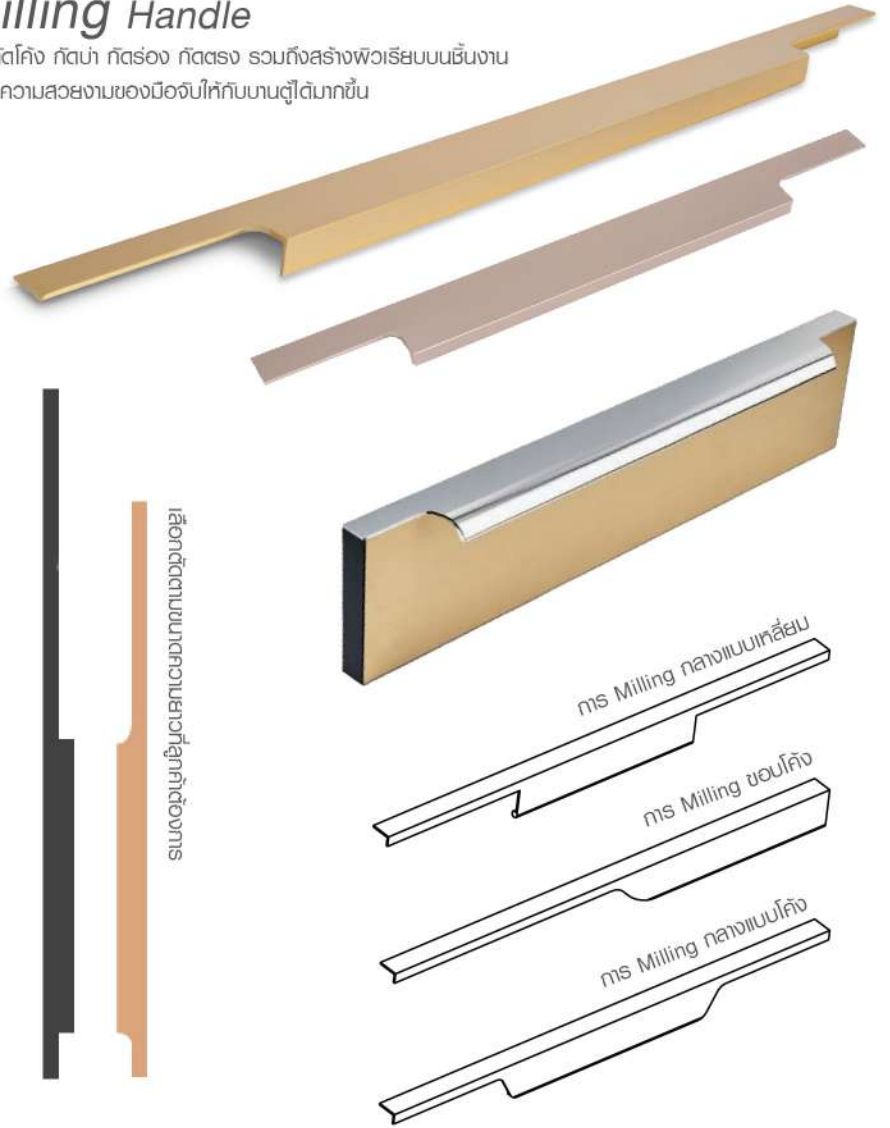

มือจับอลูมิเนียมสำหรับตู้หรือลิ้นชักทั่วไป จะมีขนาดของส่วนที่จับกับส่วนที่ยึดติดกับบานตู้เท่ากัน โดยมือจับมิลลิ่งจะเป็นการกัดส่วนของที่ใช่จับเปิด-ปิดตู้ ให้มีขนาดตามต้องการ



- |   |  |   |   |   |   |  |   |
|---|--|---|---|---|---|--|---|
| <br>สีเงนเงา<br>GLOSS SILVER | <br>สีท่อนุ่น<br>LIGHT GREY | <br>สีน้ำตาลอ่อน/สีชา<br>LIGHT BROWN | <br>สีน้ำตาลเข้ม<br>DARK BROWN   | <br>สีชมพูทอง<br>PINK GOLD | <br>สีทองเข้ม<br>DARK GOLD | <br>สีทองแบบเปล่ง<br>CHAMPAGNE GOLD | <br>สีกราฟไฟท์<br>GRAPHITE       |
| <br>สีดำเงา<br>GLOSS BLACK   | <br>สีดำด้าน<br>MATT BLACK  | <br>NEW! สีทองแดง<br>COPPER          | <br>NEW! สีโรสโกลด์<br>ROSE GOLD | <br>NEW! สีโกโก้<br>COCOA  | <br>NEW! สีทราย<br>SAND    | <br>สีน้ำตาลแบบ<br>ANIQUE BROWN     | <br>สีน้ำตาลแบบ<br>ANIQUE BRONZE |

มือจับอลูมิเนียมมีลสิ่ง แบบมีเดือยเจาะร่องไม้  
MILLING HANDLE

มือจับมีลสิ่งที่มีเดือยสำหรับการเจาะหรือเจาะร่องบนขอบไม้ เพื่อฝังมือจับให้เรียบเสมอกับพื้นผิว ไม้ที่ขึ้นออกมาเหมาะกับงานออกแบบที่ต้องการความเรียบหรู มีนิ่มอล และปลอดภัยจากการเกี่ยวเสื้อผ้า



Material : Aluminium

ITEM NO	LENGTH	FINISHING
HDAL-A349-450B	450 mm.	Matte black
HDAL-A349-600B	600 mm.	Matte black
HDAL-A349-450G	450 mm.	Gold
HDAL-A349-600G	600 mm.	Gold

มือจับอลูมิเนียมแบบยาว T-Shaped  
HANDLE LONG FURNITURE

มีขนาดยาวตั้งแต่ 2 เมตรขึ้นไปทำให้ดูเรียบหรูและต่อเนื่องถึงแนว เหมาะกับงานตกแต่งสไตล์โมเดิร์น



Material : Aluminium

ITEM NO	LENGTH	FINISHING
HDAL-A057-1000B	1000 mm.	Matte black
HDAL-A057-1000G	1000 mm.	Gold



มือจับอลูมิเนียมแบบยาว  
HANDLE LONG FURNITURE



Material : Aluminium

ITEM NO	LENGTH	FINISHING
HDAL-A145-1000B	1000 mm.	Matte black
HDAL-A145-1000G	1000 mm.	Gold



มือจับทรงบองลายเส้น  
STAINLESS HANDLES

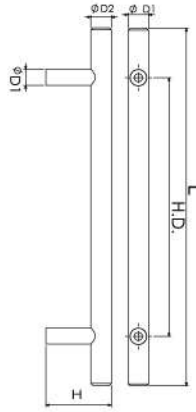

Material : Stainless Steel  
Dia : 10 mm.

ITEM NO	HOLE DISTANCE	H	L	D1	D2
TSSC-10-96	96 mm.	34 mm.	146 mm.	8 mm.	10 mm.
TSSC-10-128	128 mm.	34 mm.	177 mm.	8 mm.	10 mm.
TSSC-10-160	160 mm.	34 mm.	210 mm.	8 mm.	10 mm.
TSSC-10-192	192 mm.	34 mm.	250 mm.	8 mm.	10 mm.
TSSC-10-224	224 mm.	34 mm.	272 mm.	8 mm.	10 mm.

Material : Stainless Steel  
Dia : 12 mm.

ITEM NO	HOLE DISTANCE	H	L	D1	D2
TSSC-12-96	96 mm.	34 mm.	146 mm.	8 mm.	10 mm.
TSSC-12-128	128 mm.	34 mm.	177 mm.	8 mm.	10 mm.
TSSC-12-160	160 mm.	34 mm.	210 mm.	8 mm.	10 mm.
TSSC-12-192	192 mm.	34 mm.	250 mm.	8 mm.	10 mm.
TSSC-12-224	224 mm.	34 mm.	272 mm.	8 mm.	10 mm.



มือจับรูปโค้งลายเส้น  
STAINLESS HANDLES

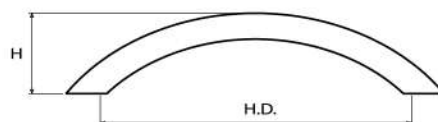

Material : Stainless Steel  
Dia : 8 mm.

ITEM NO	HOLE DISTANCE	HEIGHT(H)	FINISHING
TCS-8-64	64 mm.	26 mm.	Stainless
TCS-8-96	96 mm.	29 mm.	Stainless
TCS-8-128	128 mm.	31 mm.	Stainless
TCS-8-160	160 mm.	34 mm.	Stainless

Material : Stainless Steel  
Dia : 10 mm.

ITEM NO	HOLE DISTANCE	HEIGHT(H)	FINISHING
TCS-10-64	64 mm.	26 mm.	Stainless
TCS-10-96	96 mm.	29 mm.	Stainless
TCS-10-128	128 mm.	31 mm.	Stainless
TCS-10-160	160 mm.	34 mm.	Stainless



มือจับสเตนเลส  
STAINLESS HANDLES

STAINLESS

Material : Stainless Steel  
Dia : 10 mm.

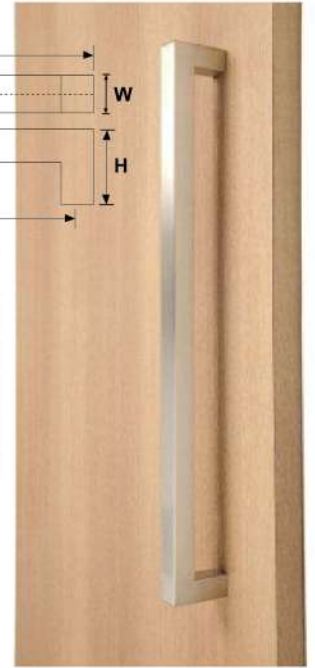
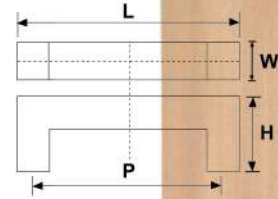

ITEM NO	SIZE (WxLxH)	HOLE DISTANCE
MT-909-96	12x108x32 mm.	96 mm.
MT-909-128	12x140x32 mm.	128 mm.
MT-909-160	12x172x32 mm.	160 mm.
MT-909-192	12x192x32 mm.	192 mm.
MT-909-224	12x236x32 mm.	224 mm.

มือจับสเตนเลส  
STAINLESS HANDLES

STAINLESS

ITEM NO	SIZE (WxLxH)	HOLE DISTANCE
MT-910-96	10x106x32 mm.	96 mm.
MT-910-128	10x138x32 mm.	128 mm.
MT-910-160	10x170x32 mm.	160 mm.

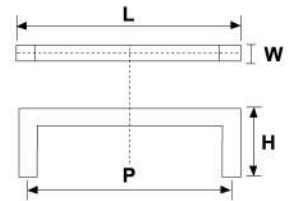

มือจับสเตนเลส  
STAINLESS HANDLES

STAINLESS

ITEM NO	SIZE (WxLxH)	HOLE DISTANCE
MT-924-96	12x156x35 mm.	96 mm.
MT-924-128	12x188x35 mm.	128 mm.
MT-924-160	12x220x35 mm.	160 mm.
MT-924-160	12x252x35 mm.	192 mm.



มือจับสเตนเลส  
STAINLESS HANDLES

STAINLESS

ITEM NO	L
HDSS-125	125 mm.
HDSS-150	150 mm.

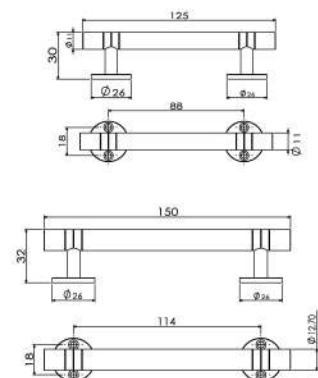

มือจับอลูมิเนียม  
ALUMINIUM HANDLES

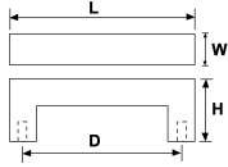

Material : Aluminium

ITEM NO	SIZE(WxLxH)	HOLE DISTANCE
MT-002-128		128 mm.
MT-002-160	13x166x34 mm.	160 mm.
MT-002-224	13x232x34 mm.	224 mm.

มือจับอลูมิเนียม  
ALUMINIUM HANDLES

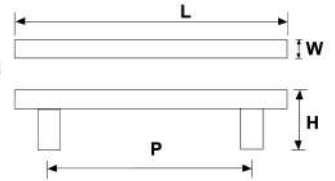

Material : Aluminium

ITEM NO	SIZE(WxLxH)	HOLE DISTANCE
TCS-8-64	12x150x25 mm.	128 mm.
TCS-8-96	12x200x25 mm.	160 mm.
TCS-8-128	12x250x25 mm.	192 mm.

มือจับอลูมิเนียม  
ALUMINIUM HANDLES



Material : Aluminium

ITEM NO	HOLE DISTANCE
HA-0528-128	128 mm.
HA-0528-160	160 mm.
HA-0528-192	192 mm.

มือจับอลูมิเนียม  
ALUMINIUM HANDLES

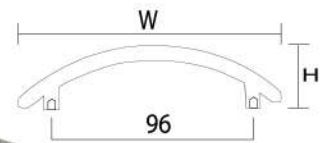

Material : Aluminium

ITEM NO	SIZE(WxH)	HOLE DISTANCE
THA-0001-96	96 mm.	128x28.5 mm.

มือจับอลูมิเนียม  
ALUMINIUM HANDLES



Material : Aluminium

ITEM NO	HOLE DISTANCE
HA-06481-96	96 mm.
HA-06481-128	128 mm.
HA-06481-160	160 mm.

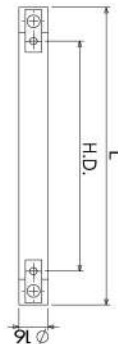

มือจับอลูมิเนียม  
ALUMINIUM HANDLES



Material : Aluminium

ITEM NO	HOLE DISTANCE
HA-06445-192	192 mm.
HA-06445-224	224 mm.

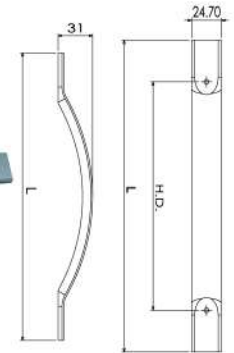

มือจับอลูมิเนียม  
ALUMINIUM HANDLES



Material : Aluminium

ITEM NO	HOLE DISTANCE
HA-0590-128	128 mm.
HA-0590-160	160 mm.
HA-0590-192	192 mm.

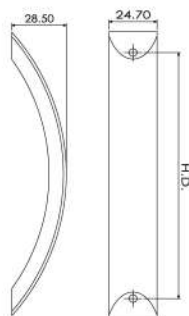

มือจับอลูมิเนียม  
ALUMINIUM HANDLES



Material : Aluminium

ITEM NO	HOLE DISTANCE
HA-06133-128	128 mm.
HA-06133-160	160 mm.
HA-06133-192	192 mm.

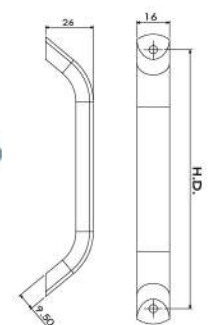

มือจับอลูมิเนียม  
ALUMINIUM HANDLES

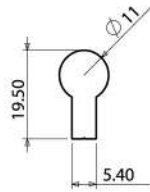

ITEM NO	HOLE DISTANCE
HA-0504-64	64 mm.
HA-0504-96	96 mm.
HA-0504-128	128 mm.
HA-0504-192	192 mm.

มือจับอลูมิเนียม  
ALUMINIUM HANDLES

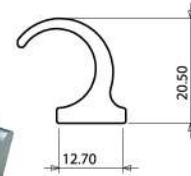

ITEM NO	HOLE DISTANCE
HA-0505-64	64 mm.
HA-0505-96	96 mm.
HA-0505-128	128 mm.
HA-0505-192	192 mm.

มือจับอลูมิเนียม  
ALUMINIUM HANDLES

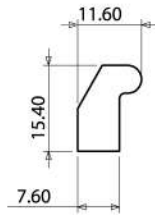

ITEM NO	HOLE DISTANCE
HA-0513-64	64 mm.
HA-0513-96	96 mm.
HA-0513-128	128 mm.
HA-0513-192	192 mm.

มือจับอลูมิเนียม  
ALUMINIUM HANDLES

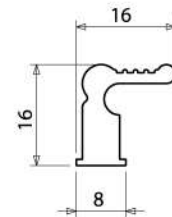

ITEM NO	HOLE DISTANCE
HA-0518-64	64 mm.
HA-0518-96	96 mm.
HA-0518-128	128 mm.
HA-0518-192	192 mm.

มือจับอลูมิเนียม  
ALUMINIUM HANDLES

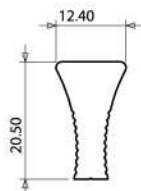

ITEM NO	HOLE DISTANCE
HA-0524-64	64 mm.
HA-0524-96	96 mm.
HA-0524-128	128 mm.
HA-0524-192	192 mm.

มือจับอลูมิเนียม  
ALUMINIUM HANDLES

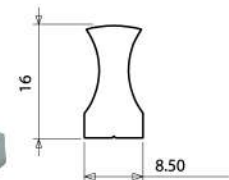

ITEM NO	HOLE DISTANCE
YCA-0503-64	64 mm.
YCA-0503-96	96 mm.
YCA-0503-128	128 mm.
YCA-0503-192	192 mm.



## ZINC ALLOY HANDLES PRODUCT

ความเรียบหรูแบบคลาสสิก บิรมิโซสีโทนดำ เทา เพื่อตอบโจทย์  
ไลฟ์สไตล์ให้ดูมีเสน่ห์ น่าค้นหาและไม่น่าเบื่อ

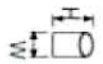
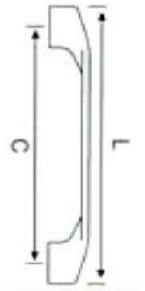

ITEM NO	HOLE DISTANCE	FINISHING
HDZN-A638-96B	96 mm.	Black Matt
HDZN-A638-128B	128 mm.	Black Matt

ITEM NO	HOLE DISTANCE	FINISHING
HDZN-A664-96B	96 mm.	Black Matt
HDZN-A664-128B	128 mm.	Black Matt

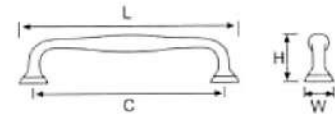

ITEM NO	HOLE DISTANCE	FINISHING
HDZN-A665-96B	96 mm.	Black Matt
HDZN-A665-128B	128 mm.	Black Matt

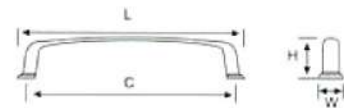

ITEM NO	HOLE DISTANCE	FINISHING
HDZN-A668-96B	96 mm.	Black Matt
HDZN-A668-128B	128 mm.	Black Matt

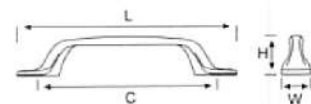

ITEM NO	HOLE DISTANCE	FINISHING
KNZN-A640B	96 mm.	Black Matt

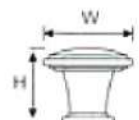

Material : Aluminium



ITEM NO	HOLE DISTANCE	FINISHING
HDZN-11001-64B	64 mm.	Black Grey
HDZN-11001-96B	96 mm.	Black Grey
HDZN-11001-128B	128 mm.	Black Grey
HDZN-11001-160B	160 mm.	Black Grey

ITEM NO	HOLE DISTANCE	FINISHING
HDZN-11001-64G	64 mm.	Matt Gold
HDZN-11001-96G	96 mm.	Matt Gold
HDZN-11001-128G	128 mm.	Matt Gold
HDZN-11001-160G	160 mm.	Matt Gold

ITEM NO	HOLE DISTANCE	FINISHING
HDZN-11001-64GR	64 mm.	Grey
HDZN-11001-96GR	96 mm.	Grey
HDZN-11001-128GR	128 mm.	Grey
HDZN-11001-160GR	160 mm.	Grey



Material : Zinc Alloy

ITEM NO	HOLE DISTANCE	FINISHING
HDZN-97001-96HL	96 mm.	Gold
HDZN-97001-128HL	128 mm.	Gold
HDZN-97001-160HL	160 mm.	Gold



Material : Zinc Alloy

ITEM NO	HOLE DISTANCE	FINISHING
HDZN-97001HL	19x28 mm.	Gold

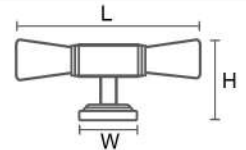

Material : Zinc Alloy

ITEM NO	SIZE(WxLxH)	FINISHING
HDZN-10188B	24x80x33 mm.	Black
HDZN-10188CG	24x80x33 mm.	Champagne Gold



Material : Zinc Alloy

ITEM NO	HOLE DISTANCE	FINISHING
HDZN-90049-16B	16 mm.	Black
HDZN-90049-16CG	16 mm.	Champagne Gold

## ZINC ALLOY HANDLES PRODUCT

• COLOR



Material : Zinc Alloy

Matt Grey    Black    Gold Hairline

ITEM NO	HOLE DISTANCE	FINISHING
HDZN-10009-96B	96 mm.	Black
HDZN-10009-128B	128 mm.	Black
HDZN-10009-160B	160 mm.	Black
HDZN-10009-96GR	96 mm.	Matt Grey
HDZN-10009-128GR	128 mm.	Matt Grey
HDZN-10009-160GR	160 mm.	Matt Grey
HDZN-10009-96HL	96 mm.	Gold Hairline
HDZN-10009-128HL	128 mm.	Gold Hairline
HDZN-10009-160HL	160 mm.	Gold Hairline



• COLOR



Material : Zinc Alloy

Black    Gold Hairline

ITEM NO	HOLE DISTANCE	FINISHING
HDZN-10012-128B	128 mm.	Black
HDZN-10012-128HL	128 mm.	Gold Hairline



• COLOR



Material : Zinc Alloy

Matt Grey    Black    Gold Hairline

ITEM NO	HOLE DISTANCE	FINISHING
HDZN-10152-96B	96 mm.	Black
HDZN-10152-128B	128 mm.	Black
HDZN-10152-96NI	96 mm.	Matt Grey
HDZN-10152-128NI	128 mm.	Matt Grey
HDZN-10152-96HL	96 mm.	Gold Hairline
HDZN-10152-128HL	128 mm.	Gold Hairline



• COLOR



Material : Zinc Alloy

Matt Grey    Black    Gold Hairline

ITEM NO	SIZE	FINISHING
HDZN-50021B	15x26.5 mm.	Black
HDZN-50021NI	15x26.5 mm.	Matt Grey
HDZN-50021HL	15x26.5 mm.	Gold Hairline



## FLUSH ZINC ALLOY HANDLES PRODUCT

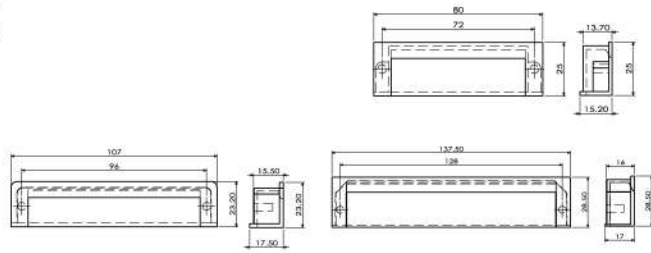
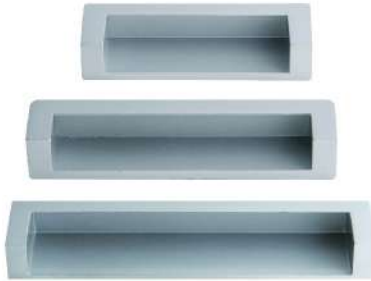

Material : Zinc Alloy

ITEM NO	HOLE DISTANCE	FINISHING
HA-0824-72	72 mm.	Satin(SA)
HA-0824-96	96 mm.	Satin(SA)
HA-0824-128	128 mm.	Satin(SA)

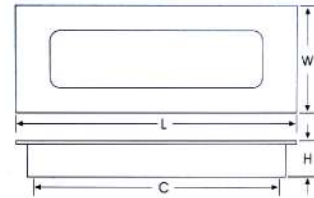

Material : Zinc Alloy

ITEM NO	HOLE DISTANCE	FINISHING
HA-06404-64	64x79x42x16 mm.	Satin(SA)
HA-06404-96	96x111x42x16 mm.	Satin(SA)
HA-06404-128	128x143x42x16 mm.	Satin(SA)

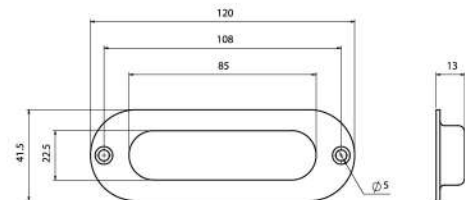

Material : Stainless

ITEM NO	HOLE DISTANCE	FINISHING
PS-3001	41.5x120x13 mm.	Stainless

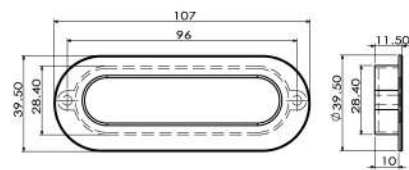

Material : Zinc Alloy

ITEM NO	HOLE DISTANCE	FINISHING
YCZ-0856-64CR	64 mm.	Chromium(CR)
YCZ-0856-96CR	96 mm.	Chromium(CR)

**FLUSH ZINC ALLOY HANDLES**  
PRODUCT

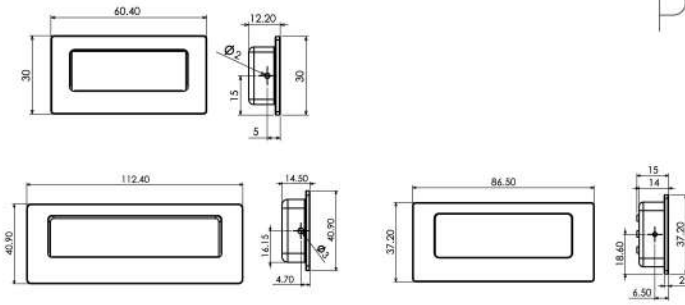

Material : Plastic

ITEM NO	HOLE DISTANCE	FINISHING
PH-03	30x60 mm.	Chromium(CR)
PH-04	32x70 mm.	Chromium(CR)
PH-05	32x94 mm.	Chromium(CR)

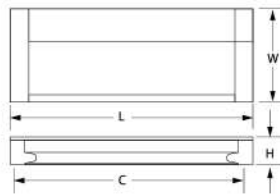

Material : Aluminium

ITEM NO	HOLE DISTANCE	FINISHING
HA-0866-64	64x77x43.5x16 mm.	Anodize
HA-0866-96	96x109x43.5x16 mm.	Anodize
HA-0866-128	128x141x43.5x16 mm.	Anodize

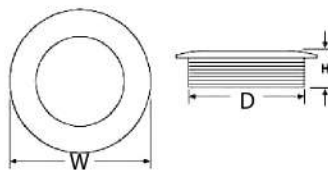

Material : Zinc Alloy

ITEM NO	HOLE DISTANCE	FINISHING
YCZ-0850	41.5x35x10.5 mm.	Satin(SA)



Material : Zinc Alloy

ITEM NO	HOLE DISTANCE	FINISHING
HDZN-11002-200B	200 mm.	Matt Black
HDZN-11002-200G	200 mm.	Matt Gold



## FLUSH ZINC ALLOY HANDLES PRODUCT



Material : Zinc Alloy

ITEM NO	HOLE DISTANCE	FINISHING
HDZN-11003S-B	Small	Matt Black
HDZN-11003S-G	Small	Matt Gold

ITEM NO	HOLE DISTANCE	FINISHING
HDZN-11004B-B	Big	Matt Black
HDZN-11004B-G	Big	Matt Gold



Material : Zinc Alloy

ITEM NO	HOLE DISTANCE	FINISHING
HDZN-11005-96B	96 mm.	Matt Black
HDZN-11005-96G	96 mm.	Matt Gold

ITEM NO	HOLE DISTANCE	FINISHING
HDZN-11006-128B	128 mm.	Matt Black
HDZN-11006-128G	128 mm.	Matt Gold



Material : Zinc Alloy

ITEM NO	HOLE DISTANCE	FINISHING
HDZN-11007SL-B	Small ช่าย	Matt Black
HDZN-11007SR-B	Small ชวว	Matt Black
HDZN-11007SL-G	Small ช่าย	Matt Gold
HDZN-11007SR-G	Small ชวว	Matt Gold

ITEM NO	HOLE DISTANCE	FINISHING
HDZN-11008BL-B	Big ช่าย	Matt Black
HDZN-11008BR-B	Big ชวว	Matt Black
HDZN-11008BL-G	Big ช่าย	Matt Gold
HDZN-11008BR-G	Big ชวว	Matt Gold



Material : Zinc Alloy

ITEM NO	HOLE DISTANCE	FINISHING
HDZN-11009-64B	64 mm.	Matt Black
HDZN-11009-96B	96 mm.	Matt Black
HDZN-11009-128B	128 mm.	Matt Black

ITEM NO	HOLE DISTANCE	FINISHING
HDZN-11010-64G	64 mm.	Matt Gold
HDZN-11010-96G	96 mm.	Matt Gold
HDZN-11010-128G	128 mm.	Matt Gold

**STAINLESS STEEL KNOBS**  
PRODUCT

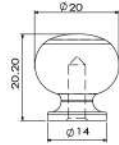

Material : Stainless

ITEM NO	FINISHING
SSBN-09	Burnished,Matte

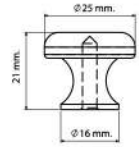

Material : Stainless

ITEM NO	FINISHING
SSBN-10	Burnished,Matte

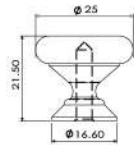

Material : Stainless

ITEM NO	FINISHING
SSBN-11	Burnished,Matte

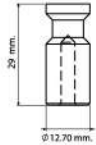

Material : Stainless

ITEM NO	FINISHING
SSBN-030	Burnished,Matte



Material : Stainless

ITEM NO	FINISHING
SSBN-031	Burnished,Matte

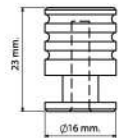

Material : Stainless

ITEM NO	FINISHING
SSBN-032	Burnished,Matte

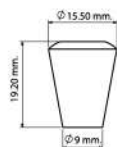

Material : Stainless

ITEM NO	FINISHING
SSSH-07	Burnished,Matte

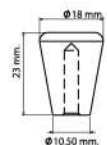

Material : Stainless

ITEM NO	FINISHING
SSSH-08	Burnished,Matte



Material : Stainless

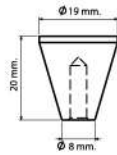

ITEM NO	FINISHING
SSSH-09	Burnished,Matte



Material : Stainless

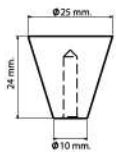

ITEM NO	FINISHING
SSSH-010	Burnished,Matte



Material : Stainless

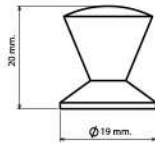

ITEM NO	FINISHING
SSTF-10	Burnished,Matte



Material : Stainless

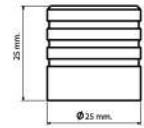

ITEM NO	FINISHING
SSSH-013	Burnished,Matte



Material : Stainless

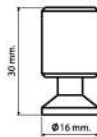

ITEM NO	FINISHING
SSTK-013	Burnished,Matte



Material : Stainless

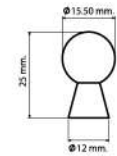

ITEM NO	FINISHING
SSTK-10	Burnished,Matte



Material : Stainless

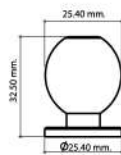

ITEM NO	FINISHING
SSTO-10	Burnished,Matte



Material : Stainless

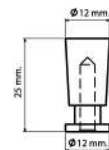

ITEM NO	FINISHING
SSTK-014	Burnished,Matte



Material : Stainless

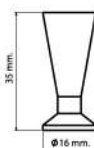

ITEM NO	FINISHING
SSSH-07	Burnished,Matte

**STEEL KNOBS**  
PRODUCT



Material : Steel

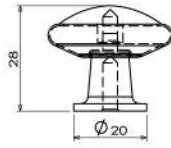

ITEM NO	FINISHING
PC-2002	Gold(G)



Material : Steel

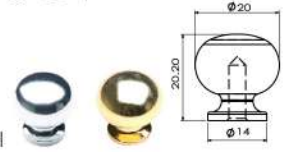

ITEM NO	FINISHING
BN-09CR	Chromium(CR)
BN-09G	Gold(G)
BN-09SA	Satin(SA)



Material : Steel

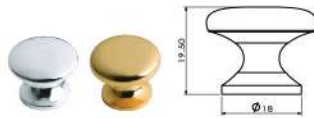

ITEM NO	FINISHING
BN-10CR	Chromium(CR)
BN-10G	Gold(G)
BN-10SA	Satin(SA)



Material : Steel

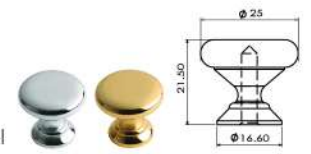

ITEM NO	FINISHING
BN-11CR	Chromium(CR)
BN-11G	Gold(G)
BN-11SA	Satin(SA)



Material : Steel

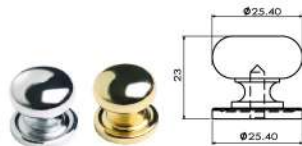

ITEM NO	FINISHING
BN-16CR	Chromium(CR)
BN-16G	Gold(G)
BN-16SA	Satin(SA)



Material : Steel

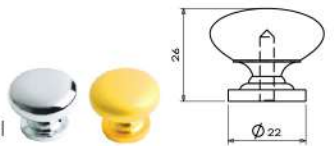

ITEM NO	FINISHING
BN-18CR	Chromium(CR)
BN-18G	Gold(G)
BN-18SA	Satin(SA)



Material : Steel



ITEM NO	FINISHING
BN-30CR	Chromium(CR)
BN-30G	Gold(G)
BN-30SA	Satin(SA)



Material : Steel



ITEM NO	FINISHING
SH-08C-G	Chromium(CR)
SH-08C-NB	Black Nikle(NB)

**STEEL KNOBS**  
PRODUCT



Material : Steel

ITEM NO	FINISHING
SH-09CR	Chromium(CR)
SH-09SA	Satin(SA)

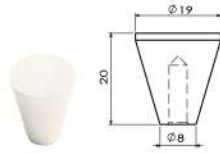

Material : Steel

ITEM NO	FINISHING
SH-10CR	Chromium(CR)
SH-10G	Gold(G)
SH-10SA	Satin(SA)

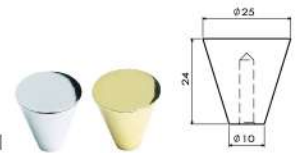

Material : Steel

ITEM NO	FINISHING
SH-011CR	Chromium(CR)
SH-011G	Gold(G)
SH-011SA	Satin(SA)

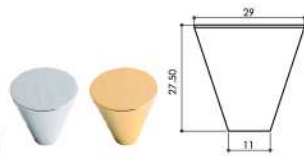

Material : Steel

ITEM NO	FINISHING
TK-010	Gold(G)

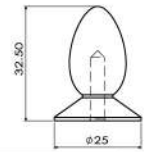

Material : Steel

ITEM NO	FINISHING
TK-011CR	Chromium(CR)
TK-011G	Gold(G)
TK-011GG	Gold(GG)
TK-011SA	Satin(SA)



Material : Steel

ITEM NO	FINISHING
TK-012CR	Chromium(CR)
TK-012G	Gold(G)
TK-012SA	Satin(SA)

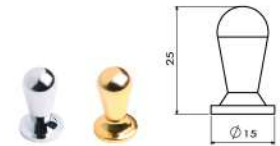

Material : Steel

ITEM NO	FINISHING
TK-014CR	Chromium(CR)
TK-014G	Gold(G)
TK-014GG	Satin(SA)



Material : Steel

ITEM NO	FINISHING
TK-017CR	Chromium(CR)
TK-017G	Gold(G)
TK-017SA	Satin(SA)

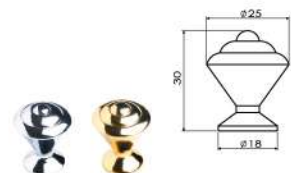



## WOODEN KNOBS PRODUCT

Wood Color



Material : Wood

ITEM NO	SIZE(WxH)	FINISHING
W-3	32x32.5 mm.	Cherry Brown
W-4	31x31 mm.	Black
W-5	32x33 mm.	Brown
W-6	32x33 mm.	Light Brown



Material : Wood

ITEM NO	SIZE(WxH)	FINISHING
W-8	34x28 mm.	Light Brown
W-13	35x27 mm.	Brown



Material : Wood

ITEM NO	SIZE(WxH)	FINISHING
W-9	33x28.5 mm.	Light Brown
W-14	32.5x28.5 mm.	Brown



Material : Wood

ITEM NO	SIZE(WxH)	FINISHING
W-17	33x32 mm.	Brown



Material : Wood

ITEM NO	SIZE(WxH)	FINISHING
W-18	35x29 mm.	Light Brown



Material : Wood

ITEM NO	SIZE(WxH)	FINISHING
W-19	35x29 mm.	Light Brown
W-20	38.5x29 mm.	Dark Brown
W-21	38x31 mm.	Brown



Material : Wood

ITEM NO	SIZE(WxH)	FINISHING
WB-12	35x29.5 mm.	Dark Brown
WB-13	37x29 mm.	Cherry Brown
WB-15	40x29 mm.	Brown



Material : Wood

ITEM NO	SIZE(WxH)	FINISHING
WB-21	31x29 mm.	Light Brown
WB-22	30x28 mm.	Dark Brown
WB-23	30x28 mm.	Cherry Brown
WB-24	29x27.5 mm.	Black
WB-25	35x27 mm.	Brown