

MOUNTING AND OPERATING INSTRUCTIONS

SAMSON

EB 8387-3 EN

Translation of original instructions



HART[®]
COMMUNICATION PROTOCOL

Type 3731-3 Electropneumatic Ex d Positioner
with HART[®] communication

Firmware version 1.61

CE EAC Ex
certified

Edition May 2017

Note on these mounting and operating instructions

These mounting and operating instructions assist you in mounting and operating the device safely. The instructions are binding for handling SAMSON devices. The images shown in these instructions are for illustration purposes only. The actual product may vary.

- For the safe and proper use of these instructions, read them carefully and keep them for later reference.
- If you have any questions about these instructions, contact SAMSON's After-sales Service (aftersaleservice@samsongroup.com).



The mounting and operating instructions for the devices are included in the scope of delivery. The latest documentation is available on our website at www.samsongroup.com > **Service & Support** > **Downloads** > **Documentation**.

Definition of signal words

DANGER

Hazardous situations which, if not avoided, will result in death or serious injury

WARNING

Hazardous situations which, if not avoided, could result in death or serious injury

NOTICE

Property damage message or malfunction

Note

Additional information

Tip

Recommended action

1	Safety instructions and measures	6
1.1	Notes on possible severe personal injury	8
1.2	Notes on possible personal injury	9
1.3	Notes on possible property damage	9
2	Markings on the device	11
2.1	Nameplate	11
2.2	Article code	12
2.3	Firmware versions	14
3	Design and principle of operation	16
3.1	Additional equipment	18
3.2	Communication	19
3.2.1	Configuration using TROVIS-VIEW	19
3.3	Accessories	20
3.4	Travel tables	23
3.5	Technical data	24
3.6	Dimensions in mm	29
3.7	Fixing levels according to VDI/VDE 3845 (September 2010)	30
4	Measures for preparation	31
4.1	Unpacking	31
4.2	Transporting	31
4.3	Storage	31
5	Mounting and start-up	32
5.1	Mounting orientation	32
5.2	Lever and pin position	32
5.3	Type 3277-5 Actuator	34
5.4	Type 3277 Actuator	36
5.5	Attachment according to IEC 60534-6 (NAMUR)	38
5.6	Attachment to Type 3510 Micro-flow Valve	40
5.7	Attachment to rotary actuators	42
5.8	Reversing amplifier for double-acting actuators	44
5.8.1	Reversing amplifier (1079-1118 or 1079-1119)	46
5.9	Pneumatic connections	47
5.10	Connecting the supply air	47
5.10.1	Signal pressure connection	48
5.10.2	Signal pressure reading	48
5.10.3	Supply pressure	48
5.10.4	Signal pressure (output)	49

Contents

5.11	Electrical connections	49
5.11.1	Connecting the electrical supply	51
5.11.2	Establishing communication	51
6	Operating controls and readings.....	54
6.1	Rotary pushbutton	54
6.2	Serial interface	54
6.3	Reading	55
6.4	HART® communication	57
6.4.1	Dynamic HART® variables.....	57
7	Operating the positioner.....	59
7.1	Adapting the display direction	59
7.2	Limiting the signal pressure	60
7.3	Checking the operating range of the positioner	61
7.4	Determining the fail-safe position	62
7.5	Initializing the positioner	63
7.5.1	Initialization based on maximum range (MAX).....	65
7.5.2	Initialization based on nominal range (NOM)	66
7.5.3	Initialization based on a manually selected range (MAN).....	68
7.5.4	Substitute calibration (SUB).....	70
7.6	Zero calibration	76
7.7	Reset to default settings.....	77
8	Operation	79
8.1	Enabling and selecting parameters	79
8.2	Operating modes.....	80
8.2.1	Automatic (AUTO) and manual (MAN) modes	80
8.2.2	Fail-safe position (SAFE)	82
8.3	Fault/malfunction.....	82
8.3.1	Confirming error messages.....	84
9	Servicing.....	85
9.1	Preparation for return shipment.....	85
10	Malfunctions	86
10.1	Emergency action	86
11	Decommissioning and removal	86
11.1	Decommissioning.....	86
11.2	Removing the positioner	86
11.3	Disposal.....	87

12	Annex.....	87
12.1	After-sales service	87
12.2	Code list.....	88
12.3	Error codes.....	98
12.4	Valve characteristic selection.....	106

i Note

The functions of the **EXPERTplus** Valve Diagnostics are described in the Operating Instructions
▶ **EB 8389**.

1 Safety instructions and measures

Intended use

The SAMSON Type 3731-3 Positioner is mounted on pneumatic control valves and used to assign the valve position to the control signal. The device is designed to operate under exactly defined conditions (e.g. operating pressure, temperature). Therefore, operators must ensure that the positioner is only used in applications where the operating conditions correspond to the technical data. In case operators intend to use the positioner in applications or conditions other than those specified, contact SAMSON.

SAMSON does not assume any liability for damage resulting from the failure to use the device for its intended purpose or for damage caused by external forces or any other external factors.

→ Refer to the technical data for limits and fields of application as well as possible uses.

Reasonably foreseeable misuse

The Type 3731-3 Positioner is **not** suitable for the following applications:

- Use outside the limits defined during sizing and by the technical data

Furthermore, the following activities do not comply with the intended use:

- Use of non-original spare parts
- Performing maintenance activities not described in these instructions

Qualifications of operating personnel

The positioner must be mounted, started up and serviced by fully trained and qualified personnel only; the accepted industry codes and practices must be observed. According to these mounting and operating instructions, trained personnel refers to individuals who are able to judge the work they are assigned to and recognize possible hazards due to their specialized training, their knowledge and experience as well as their knowledge of the applicable standards.

The explosion-protected versions of the Type 3731-3 Positioner must only be handled by personnel who has undergone special training or instructions or who is authorized to work on explosion-protected devices in hazardous areas.

Personal protective equipment

No personal protective equipment is required for the direct handling of the positioner. Work on the control valve may be necessary when mounting or removing the device.

- Observe the requirements for personal protective equipment specified in the valve documentation.
- Check with the plant operator for details on further protective equipment.

Revisions and other modifications

Revisions, conversions or other modifications of the product are not authorized by SAMSON. They are performed at the user's own risk and may lead to safety hazards, for example. Furthermore, the product may no longer meet the requirements for its intended use.

Safety features

Upon failure of the air supply, the positioner vents the actuator, causing the valve to move to the fail-safe position determined by the actuator.

Warning against residual hazards

The positioner has direct influence on the control valve. To avoid personal injury or property damage, plant operators and operating personnel must prevent hazards that could be caused in the control valve by the process medium, the operating pressure, the signal pressure or by moving parts by taking appropriate precautions. Plant operators and operating personnel must observe all hazard statements, warnings and caution notes in these mounting and operating instructions, especially for installation, start-up and service work.

If inadmissible motions or forces are produced in the pneumatic actuator as a result of the supply pressure, it must be restricted using a suitable supply pressure reducing station.

Responsibilities of the operator

Operators are responsible for proper use and compliance with the safety regulations.

Operators are obliged to provide these mounting and operating instructions to the operating personnel and to instruct them in proper operation. Furthermore, operators must ensure that operating personnel or third parties are not exposed to any danger.

Responsibilities of operating personnel

Operating personnel must read and understand these mounting and operating instructions as well as the specified hazard statements, warnings and caution notes. Furthermore, the operating personnel must be familiar with the applicable health, safety and accident prevention regulations and comply with them.

Safety instructions and measures

Servicing explosion-protected devices

If a part of the device on which the explosion protection is based needs to be serviced, the device must not be put back into operation until a qualified inspector has assessed it according to explosion protection requirements, has issued an inspection certificate or given the device a mark of conformity. Inspection by a qualified inspector is not required if the manufacturer performs a routine test on the device before putting it back into operation and the passing of the routine test is documented by attaching a mark of conformity to the device.

Referenced standards, directives and regulations

Devices with a CE marking fulfill the following requirements of the Directives:

- Type 3731-3: 2014/30/EU, 2011/65/EU
- Type 3731-321: 2014/30/EU, 2014/34/EU, 2011/65/EU

Devices with an EAC marking fulfill the requirements of the Regulation TR CU 020/2011.

See Annex for declarations of conformity and EAC certificates.

Referenced documentation

The following documents apply in addition to these mounting and operating instructions:

- Operating instructions of EXPERTplus Valve Diagnostics ► EB 8389
- The mounting and operating instructions of the components on which the positioner is mounted (valve, actuator, valve accessories etc.).

1.1 Notes on possible severe personal injury

DANGER

Risk of fatal injury due to the formation of an explosive atmosphere.

Incorrect installation, operation or maintenance of the positioner in potentially explosive atmospheres may lead to ignition of the atmosphere and ultimately to death.

- ➔ The following regulations apply to installation in hazardous areas: EN 60079-14 (VDE 0165, Part 1).
- ➔ Installation, operation or maintenance of the positioner is to be performed only by personnel who has undergone special training or instructions or who is authorized to work on explosion-protected devices in hazardous areas.

1.2 Notes on possible personal injury

WARNING

Risk of personal injury due to moving parts on the valve.

During initialization of the positioner and during operation, the valve moves through its entire travel range. Injury to hands or fingers is possible if they are inserted into the valve.

- During initialization, do not insert hands or fingers into the valve yoke and do not touch any moving valve parts.

1.3 Notes on possible property damage

NOTICE

Risk of damage to the positioner due to incorrect mounting position.

- Do not mount the positioner with the back of the device facing upward.
- Do not seal or restrict the vent opening when the device is installed on site.

Risk of malfunction due to incorrect sequence during start-up.

The positioner can only work properly if the mounting and start-up are performed in the prescribed sequence.

- Perform mounting and start-up as described in section 5.

An incorrect electric signal will damage the positioner.

A current source must be used to power the positioner.

- Only use a current source and never a voltage source.

Incorrect assignment of the terminals will damage the positioner and will lead to malfunction.

For the positioner to function properly, the prescribed terminal assignment must be observed.

- Connect the electrical wiring according to the prescribed terminal assignment.

Malfunction due to initialization not yet completed.

The initialization causes the positioner to be calibrated to adapt it to the mounting situation. After initialization is completed, the positioner is ready for use.

- Initialize the positioner on first start-up.
- Re-initialize positioner after changing the mounting position.

Risk of positioner damage due to incorrect grounding of the electric welding equipment.

- Do not ground electric welding equipment near the positioner.

2 Markings on the device

2.1 Nameplate

samson 3731 - 3			11
HART [®] capable Positioner			
Supply	1		
2			
Input signal 4 to 20 mA (polarity insensitive) Shutdown at 3.8 mA			
Option:			
3			
<p>⚠ * See technical data and explosion-protection certificate for permissible ambient temperature and maximum values.</p>			
Date	4		12
SAM	5	HV 6 SV 7	
Mat.	8		
S/N	9		
Model	10		
SAMSON AG D-60314 Frankfurt		Made in Germany	
Output	-NPT-	Supply	

- 1 Supply pressure
- 2 Type of protection
- 3 Options
- 4 Date of manufacture
- 5 Code for NAMUR Recommendation NE 53 (internal specification)
- 6 Hardware version
- 7 Software version
- 8 Material number
- 9 Serial number
- 10 Model number
- 11 Approvals (CE, EAC, UKCA etc.)
- 12 Data Matrix code (electronic nameplate)

i Note

The nameplate layout may vary depending on the certification.

Positioner		Type 3731- 3															
		x	x	x	x	x	x	x	x	0	0	x	1	x	0	0	0
Explosion protection certificate																	
CCC Ex	Ex d IIC T4 ~ T6 Gb	2	1										1				
	Ex de IIC T4 ~ T6 Gb																
	Ex tD A21 IP66 T80°C																
IECEX	Ex d IIC T6, T5, T4 Gb;	2	1										2				
	Ex de IIC T6, T5, T4 Gb;																
	Ex tb IIIC T80°C Db IP66																
CCoE	Ex d IIC T6																
EAC Ex	1Ex d IIC T6/T5/T4 Gb X	2	1										3				
	Ex tb IIIC T 80 °C Db X																
KCS	Ex d IIC T6/T5/T4	2	1										5				
INMETRO	Ex d IIC T6, T5, T4 Gb	2	1										6				
	Ex de IIC T6, T5, T4 Gb																
TR CMU 1055	Ex d IIC T6	2	1										7				
Special applications																	
Without														0			
Special version																	
Without															0	0	0

2.3 Firmware versions

Firmware revisions	
Old	New
1.41	1.42
	After performing a cold start, the allocation of the fail-safe position AIR TO OPEN (AtO)/AIR TO CLOSE (AtC) is not reset to the default setting. The setting is kept.
1.42	1.51
	All EXPERTplus diagnostic functions are available without having to activate them in the positioner (► EB 8389 on EXPERTplus Valve Diagnostics). Optional binary input with following actions: <ul style="list-style-type: none"> – Transmit switching state – Activate local write protection – Switch between automatic and manual modes – Various diagnostic functions ► EB 8389 (EXPERTplus valve diagnostics) The pressure limit (Code 16) is no longer automatically set during initialization.
1.51	1.52
	Internal revisions
1.52	1.53
	Internal revisions
1.53	1.60
	Internal revisions
1.60	1.61
	<ul style="list-style-type: none"> – Default values of the step response test have been adapted to the positioner series. – Optimizations made to the step response test. – A positioner that has not yet been initialized has 'Out of specification' NAMUR status (previously 'Maintenance alarm'). – Code 4: the setting for 300 mm has been added to the pin positions.

3 Design and principle of operation

→ Refer to Fig. 1

The electropneumatic Ex d positioner is mounted on pneumatic control valves and used to assign the valve position (controlled variable x) to the control signal (set point w). The positioner compares the electric control signal of a control system to the travel or rotational angle of the control valve and issues a signal pressure (output variable y) for the pneumatic actuator.

The positioner consists of an electric travel sensor system (2), an analog i/p converter (6) with a downstream air booster (7) and the electronics with microcontroller (5).

When a set point deviation occurs, the actuator is either vented or filled with air. The signal pressure supplied to the actuator can be limited by software or on site to 1.4, 2.4 or 3.7 bar. The fixed flow regulator (9) ensures a constant air flow to the atmosphere, which is used to flush the inside of the positioner housing and to optimize the air booster (7). The i/p converter (6) is supplied with a constant upstream pressure by the pressure regulator (8) to compensate for any fluctuations in the supply pressure.

All parts are enclosed in an Ex d enclosure. The electrical connection is established over a separate terminal compartment also with Ex d protection.

The extended EXPERTplus diagnostics are integrated into the positioner. They provide information on the positioner and generate

diagnostic and status messages, which allow faults to be pinpointed quickly.

The positioner is suitable for the following types of attachment using the corresponding accessories:

- Direct attachment to SAMSON Type 3277-5 Actuator:
→ See section 5.3
- Direct attachment to SAMSON Type 3277 Actuator:
→ See section 5.4
- Attachment to actuators according to IEC 60534-6 (NAMUR):
→ See section 5.5
- Attachment to Type 3510 Micro-flow Valve:
→ See section 5.6
- Attachment to rotary actuators according to VDI/VDE 3845:
→ See section 5.7

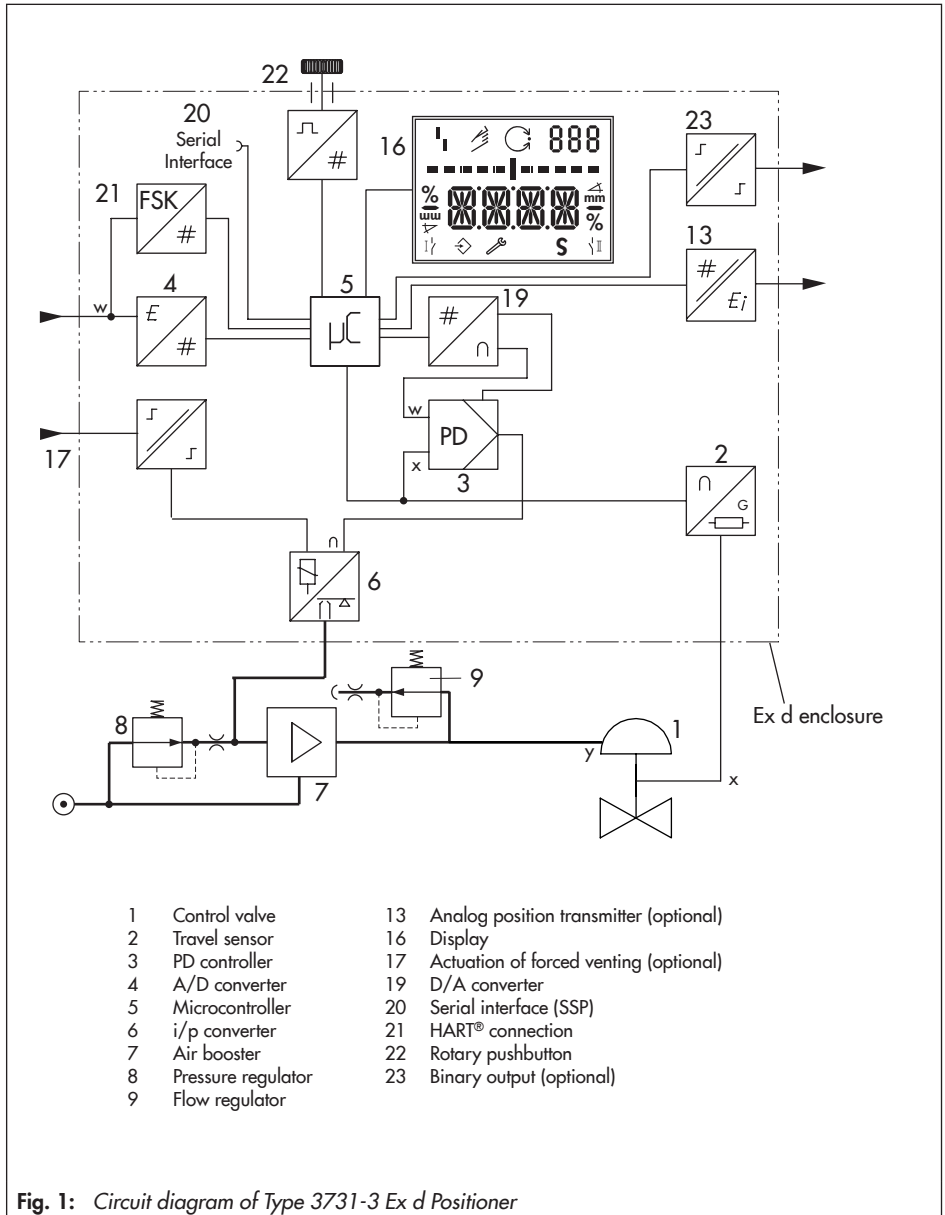

3.1 Additional equipment

Forced venting

The i/p converter is not activated when no operating voltage is applied to the corresponding terminals. The positioner can no longer operate and the control valve moves to the fail-safe position (SAFE) determined by the actuator, regardless of the set point.

Binary contact

The positioner has three internal binary signals which can be analyzed over terminals A/B/C. Two of these signals are intended for the valve end positions and one signal for a collective fault alarm. The assignment of these signals to the A/B/C terminals is determined over Code **25**.

Position transmitter

The position transmitter (13) is a two-wire transmitter and issues the travel sensor signal as a 4 to 20 mA signal processed by the microcontroller. Since this signal is issued independent of the positioner's input signal (minimum current 3.8 mA), the momentary travel/angle of rotation is controlled in real-time. Additionally, the position transmitter allows positioner faults to be indicated over a signal current of 2.4 mA or 21.6 mA.

Binary input

Positioners can be optionally fitted with a binary input. The following actions can be triggered by changing the edge state:

- **Transmit switching state** [default]
The switching state of the binary input is logged.

- **Set on-site operation write protection**
While the binary input is active, no settings can be changed at the positioner. Enabling configuration over Code **3** is not active.
- **Switch between AUTO/MAN**
The positioner changes from the automatic mode (**AUTO**) to the manual mode (**MAN**) or vice versa. This function is not performed if the positioner is in the fail-safe position mode (**SAFE**).
- **Various diagnostic functions** ► EB 8389 (EXPERTplus valve diagnostics)

i Note

The optional binary input can only be configured using the TROVIS-VIEW software and using the DD parameters (► EB 8389 on EXPERTplus valve diagnostics). The default switching state is with an open switch.

Connection to terminals A-B:

binary input for DC voltage signals

Connection to terminals B-C:

contact input for an external contact

3.2 Communication

The positioner is equipped with an interface for HART® protocol (Highway Addressable Remote Transducer) for communication purposes. Data are transmitted in a superimposed frequency (FSK = Frequency Shift Keying) on the existing signal loop for the 4 to 20 mA set point. Either a HART® capable handheld communicator or a computer with FSK modem can be used to establish communication and operate the positioner.

3.2.1 Configuration using TROVIS-VIEW

The positioner can be configured with SAMSON's TROVIS-VIEW Software. For this purpose, the positioner has a digital interface (**SSP**) to allow the USB port of a computer to be connected to it using an adapter cable. The TROVIS-VIEW software enables the user to easily configure the positioner as well as view process parameters online.

i Note

TROVIS-VIEW can be downloaded free of charge from our website at

► www.samsongroup.com > SERVICE & SUPPORT > Downloads > TROVIS-VIEW .

3.3 Accessories

Table 1: Direct attachment to Type 3277-5 (section 5.3)

Mounting parts		Order no.
Standard version for actuators 120 cm ² or smaller		1400-7452
Accessories for actuator		Order no.
Old switchover plate for Type 3277-5xxxxx.00 Actuator (old)		1400-6819
New switchover plate for Type 3277-5xxxxx.01 Actuator (new) ¹⁾		1400-6822
New connecting plate for Type 3277-5xxxxx.01 Actuator (new) ¹⁾		G 1/8 and 1/8 NPT 1400-6823
Old connecting plate for Type 3277-5xxxxx.00 Actuator (old)		G 1/8 1400-6820
Old connecting plate for Type 3277-5xxxxx.00 Actuator (old)		1/8 NPT 1400-6821
Accessories for positioner		Order no.
Connecting plate (6)		G 1/4 1400-7461
Pressure gauge bracket (7)		G 1/4 1400-7458
		1/4 NPT 1400-7459
Pressure gauge mounting kit (8) up to max. 6 bar (output/supply)		Stainless steel/brass 1402-0938
		Stainless steel/stainless steel 1402-0939

¹⁾ Only new switchover and connecting plates can be used with new actuators (Index 01). Old and new plates are **not** interchangeable.

Table 2: Direct attachment to Type 3277 (section 5.4)

Mounting parts		Order no.
Standard version for actuators 175, 240, 350, 355, 700, 750 cm ²		1400-7453
Connection block with seals and screw		G 1/4 1400-8819
		1/4 NPT 1402-0901
Pressure gauge mounting kit up to max. 6 bar (output/supply)		Stainless steel/brass 1402-0938
		Stainless steel/stainless steel 1402-0939
Piping with screw fittings ¹⁾		Order no.
Actuator (175 cm ²), steel		G 1/4/G 3/8 1402-0970
		1/4 NPT/3/8 NPT 1402-0976
Actuator (175 cm ²), stainless steel		G 1/4/G 3/8 1402-0971
		1/4 NPT/3/8 NPT 1402-0978
Actuator (240 cm ²), steel		G 1/4/G 3/8 1400-6444
		1/4 NPT/3/8 NPT 1402-0911
Actuator (240 cm ²), stainless steel		G 1/4/G 3/8 1400-6445
		1/4 NPT/3/8 NPT 1402-0912
Actuator (350 cm ²), steel		G 1/4/G 3/8 1400-6446
		1/4 NPT/3/8 NPT 1402-0913

Actuator (350 cm ²), stainless steel	G ¼/G ¾	1400-6447
	¼ NPT/¾ NPT	1402-0914
Actuator (355 cm ²), steel	G ¼/G ¾	1402-0972
	¼ NPT/¾ NPT	1402-0979
Actuator (355 cm ²), stainless steel	G ¼/G ¾	1402-0973
	¼ NPT/¾ NPT	1402-0980
Actuator (700 cm ²), steel	G ¼/G ¾	1400-6448
	¼ NPT/¾ NPT	1402-0915
Actuator (700 cm ²), stainless steel	G ¼/G ¾	1400-6449
	¼ NPT/¾ NPT	1402-0916
Actuator (750 cm ²), steel	G ¼/G ¾	1402-0974
	¼ NPT/¾ NPT	1402-0981
Actuator (750 cm ²), stainless steel	G ¼/G ¾	1402-0975
	¼ NPT/¾ NPT	1402-0982

- ¹⁾ For "actuator stem retracts" direction of action;
 with air purging of the top diaphragm chamber;
 air purging of the spring chamber for "actuator stem extends" direction of action

Table 3: Attachment according to IEC 60534-6 ¹⁾ (see section 5.5)

Travel in mm	Lever	For actuator	Order no.
7.5	S	Type 3271-5 with 60/120 cm ² on Type 3510 Micro-flow Valve	1402-0478
5 to 50	M ¹⁾	Actuators from other manufacturers and Type 3271 with 120 to 700 cm ² areas	1400-7454
14 to 100	L	Actuators from other manufacturers and Type 3271 with 1000 and 1400-60 cm ²	1400-7455
30 or 60	L	Type 3271, 1400-120 and 2800 cm ² versions with 30/60 mm travel	1400-7466
		Mounting brackets for Emerson and Masoneilan linear actuators (in addition, a mounting kit according to IEC 60534-6 is required depending on the travel). See rows above.	1400-6771
		Valtek Type 25/50	1400-9554
40 to 200	XL	Actuators from other manufacturers and Type 3271 with 1400-120 and 2800 cm ² and with 120 mm travel	1400-7456
Accessories			Order no.
Connecting plate		G ¼	1400-7461
Pressure gauge bracket		G ¼	1400-7458
		¼ NPT	1400-7459
Pressure gauge mounting kit up to max. 6 bar (output/supply)		Stainless steel/brass	1402-0938
		Stainless steel/stainless steel	1402-0939

- ¹⁾ M lever is mounted on basic device (included in the scope of delivery)

Design and principle of operation

Table 4: Attachment to rotary actuators (section 5.7)

Mounting parts/accessories		Order no.	
Attachment acc. to VDI/VDE 3845 (September 2010), see section 3.7 for details			
Size AA1 to AA4, heavy-duty version		1400-9244	
Size AA5, heavy-duty version (e.g. Air Torque 10 000)		1400-9542	
Bracket surface corresponds to fixing level 2, heavy-duty version		1400-9526	
Attachment to SAMSON Type 3278 with 160 cm ² and to VETEC Type S160, Type R and Type M, heavy-duty version		1400-9245	
Attachment to SAMSON Type 3278 with 320 cm ² and to VETEC Type S320, heavy-duty version		1400-5891 and 1400-9526	
Attachment to Camflex II		1400-9120	
Accessories	Connecting plate	G ¼	1400-7461
	Pressure gauge bracket	G ¼	1400-7458
		¼ NPT	1400-7459
	Pressure gauge mounting kit up to max. 6 bar (output/supply)	Stainless steel/brass	1402-0938
Stainless steel/stainless steel		1402-0939	

Table 5: General accessories

Designation	Order no.
Reversing amplifier for double-acting actuators	Type 3710
Signal pressure restrictions (screw restriction (item no. 0390-1424) and s restriction (item no. 0390-1423))	1400-6964
Isolated USB interface adapter (SAMSON SSP interface to USB port on a computer) including TROVIS-VIEW CD-ROM	1400-9740

Table 6: Accessories for electrical connection

Mounting parts	Order no.	
Plastic cable gland M20x1.5, black (Ex e)	8808-0178	
Blanking plug, Ex de, stainless steel (certification CENELEC, CSA, GOST, IECEx)	M20x1.5	8323-1203
	½ NPT	8323-1204
Cable entry for non-armored cable (Ex e, Ex d, Ex tD A21) (certification CENELEC, IECEx)	M20x1.5	8808-0200
	½ NPT	8808-2010
Reducing union/adaptor; Ex II 2 G Ex e II, Ex d IIG, Ex II 2 D Ex 1D; stainless steel	M20x1.5 to ½ NPT	8808-2015
Reducing union/adaptor; Ex d IC, Ex d IIC, Ex e IC, Ex e IIC; brass	½ NPT to M20x1.5	100079757

3.4 Travel tables

i Note

The **M** lever is included in the scope of delivery.

S, **L**, **XL** levers for attachment according to IEC 60534-6 (NAMUR) are available as accessories (see 21 on page Table 3).

Table 7: Direct attachment to Type 3277 Actuator (see section 5.4)

Actuator size [cm ²]	Rated travel [mm]	Adjustment range at positioner ¹⁾		Required lever	Assigned pin position
		Travel [mm]			
120	7.5	5.0 to 25.0		M	25
120/175/240/350	15	7.0 to 35.0		M	35
355/700/750	30	10.0 to 50.0		M	50

Table 8: Attachment according to IEC 60534-6 (see section 5.5)

SAMSON valves with Type 3271 Actuator		Adjustment range at positioner ¹⁾ Other control valves		Required lever	Assigned pin position
Actuator size [cm ²]	Rated travel [mm]	Min. travel [mm]	Max. travel [mm]		
120	7.5	5.0	25.0	M	25
120/175/240/350	15	7.0	35.0	M	35
355/700/750	7.5				
355/700/750	15 and 30	10.0	50.0	M	50
1000/1400/2800	30	14.0	70.0	L	70
	60	20.0	100.0	L	100
1400/2800	120	40.0	200.0	XL	200
See manufacturer's specifications	200	See manufacturer's specifications			300

Table 9: Attachment to rotary actuators (section 5.7)

Opening angle	Required lever	Assigned pin position
24 to 100°	M	90°

¹⁾ Values are based on **NOM** initialization

3.5 Technical data

Table 10: Type 3731-3 Positioner

Type 3731-3 (technical data in test certificates additionally apply to explosion-protected devices)		
Rated travel	Adjustable	Direct attachment to Type 3277 Actuator: 3.6 to 30 mm Attachment according to IEC 60534-6-1: 3.6 to 300 mm Rotary actuators: 24 to 100° opening angle
Travel range	Adjustable	Adjustable within the initialized travel/angle of rotation; travel can be restricted to 1/5 at the maximum
Set point	Signal range	4 to 20 mA · Two-wire device, reverse polarity protection · Minimum span 4 mA
	Static destruction limit	40 V · Internal current limit 60 mA
Failure behavior		Type 3731-3xxxxxx000x1x00: emergency shutdown at 0 mA Type 3731-3xxxxxx100x1x00: emergency shutdown at 3.85 mA ±0.5 mA
Minimum current		3.6 mA for display Load impedance ≤9 V corresponding to 450 Ω at 20 mA
Supply air		Type 3731-321, Type 3731-327: 1.4 to 7 bar (20 to 105 psi), Type 3731-323: 1.4 to 6 bar (20 to 90 psi)
	Air quality acc. to ISO 8573-1 (2004 edition)	Maximum particle size and density: Class 4 · Oil content: Class 3 Moisture and water: Class 3 · Pressure dew point at least 10 K below the lowest ambient temperature to be expected
Signal pressure (output)		0 bar up to the supply pressure · Can be limited to 1.4 bar/2.4 bar/3.7 bar ± 0.2 bar by software
Characteristic		Linear/Equal percentage/Reverse equal percentage Butterfly valve, rotary plug valve or segmented ball valve: Linear/equal percentage User-defined: adjustable over operating software and communication
	Deviation	≤1 %
Hysteresis		≤0.3 %
Sensitivity		≤0.1 %
Transit time		Exhaust and supply adjustable separately up to 240 s by software
Direction of action		Reversible
Air consumption	Steady state	Independent of supply air, approx. < 110 l _n /h
Air output capacity	Actuator (supply)	At Δp = 6 bar: 8.5 m _n ³ /h · At Δp = 1.4 bar: 3.0 m _n ³ /h · K _{Vmax(20 °C)} = 0.09
	Actuator (exhaust)	At Δp = 6 bar: 14.0 m _n ³ /h · At Δp = 1.4 bar: 4.5 m _n ³ /h · K _{Vmax(20 °C)} = 0.15
Permissible ambient temperature		-40 to +80 °C, the limits in the test certificate additionally apply.
Permissible storage temperature		-60 to +80 °C

Influences	Temperature	≤0.2 %/10 K	
	Supply air	None	
	Effect of vibration	≤0.25 % up to 2000 Hz and 4 g according to IEC 770	
Electromagnetic compatibility	Complying with EN 61000-6-2, EN 61000-6-3, EN 61326-1 and NAMUR Recommendation NE 21		
Electrical connections	Two tapped holes ½ NPT or optionally M20x1.5 · Screw terminals for 2.5 mm ² wire cross-section		
Degree of protection	IP 66/NEMA 4X		
Use in safety-instrumented systems (SIL)	Observing the requirements of IEC 61508, the systematic capability of the pilot valve for emergency venting as a component in safety-instrumented systems is given.		
	Use is possible on observing the requirements of IEC 61511 and the required hardware fault tolerance in safety-instrumented systems up to SIL 2 (single device/HFT = 0) and SIL 3 (redundant configuration/HFT = 1).		
Conformity			
Explosion protection			
	Refer to Table 11		
Communication			
Local communication	SAMSON SSP interface and serial interface adapter		
Software requirements (SSP)	TROVIS-VIEW with database module 3731-3		
HART® communication	HART® field communication protocol Impedance in HART® frequency range: Receiving approx. 455 Ω, sending approx. 185 Ω		
Software requirements (HART®)	For handheld communicator	Device description for Type 3731-3	
	For computer	DTM file certified according to specification 1.2, suitable for integrating the device into frame applications that support the use of FDT/DTM (e.g. PACTware); Integration into AMS™ Suite available	
Materials			
Enclosure	Die-cast aluminum EN AC-ALSi10Mg (Fe) (EN AC-43400) according to DIN 1706, chromate and powder coating		
External parts	Stainless steel 1.4301/1.4404(316L)/1.4310		
Weight	Approx. 2.5 kg		
Optional binary output	Software limit contact galvanically isolated, optionally NAMUR (EN 60947-5-6) or PLC		
Signal state	Terminals B-C, switching output AC/DC (PLC)	Terminals A-B	
	Conducting/residual voltage <1.7 V	≥2.2 mA	
	Non-conducting/high resistance, I <100 μA	≤1.0 mA	



Design and principle of operation

Operating voltage	Switching capacity: 40 V DC/28 V AC/0.3 A Static destruction limit: 45 V DC/32 V AC/0.4 A	Only for connection to NAMUR switching amplifier according to EN 60947-5-6
Optional binary input	Galvanically isolated, optionally for detection of an externally applied voltage or for operation of an external floating contact · Switching behavior configured as required, default setting (see below)	
Voltage input function Polarity insensitive, 0 to 24 V DC voltage to be applied, input resistance 6.5 kΩ		
Static destruction limit	40 V	
Voltage	>6 V: ON switching state <4 V: OFF switching state	
Contact input function For external switch (floating contact)		
Electric data	Open-circuit voltage when contact is open: max. 10 V · Pulsed DC current reaching peak value of 100 mA	
Contact	Closed	ON switching state
	Open	OFF switching state
Optional forced venting	Galvanic isolation	
Input	0 to 40 V DC/0 to 28 V AC, static destruction limit 45 V DC/32 V AC, input resistance ≥ 7 kΩ	
Signal	Fail-safe position at input voltage < 3 V Normal operation at input voltage >5.5 V	
Optional analog position transmitter	Two-wire transmitter	
Power supply	11 to 35 V DC, reverse polarity protection, static destruction limit 45 V DC	
Output signal	4 to 20 mA	
Operating direction	Reversible	
Operating range	-1.25 to 103 % of the travel range, corresponding to 3.8 to 20.5 mA Optionally also for fault alarm over 2.4 or 21.6 mA according to NAMUR Recommendation NE 43	
Characteristic	Linear	
Hysteresis and high-frequency influence	Same as positioner	
Other influences	Same as positioner	
Fault alarm	Issued as status current 2.4 mA or 21.6 mA	

Table 11: Summary of explosion protection approvals

Type	Certification	Type of protection/comments
-321	 <p>Number PTB 11 ATEX 1014 X Date 2019-04-08 EC type examination certificate</p>	<p>II 2G Ex db IIC T6 Gb, II 2G Ex db eb IIC T6 Gb II 2G Ex db [ia Ga] IIC T6 Gb II 2G Ex ia IIC T6 Ga II 2D Ex tb IIIC T80°C Db</p>
	<p>ERC</p> <p>Number RU C-DE. HA65.B.00510/20 Date 2020-03-18 Valid until 2025-03-18</p>	<p>1Ex d IIC T6/T5/T4 Gb X 1Ex d e IIC T6/T5/T4 Gb X Ex tb IIIC T 80 °C Db X</p>
3731	<p>CCC Ex</p> <p>Number 2020322307002427 Date 2021-02-10 Valid until 2025-09-27</p>	<p>Ex d IIC T4 ~ T6 Gb Ex de IIC T4 ~ T6 Gb Ex tD A21 IP66 T80°C</p>
	<p>CCoE</p> <p>Number A P HQ MH 104 6238 Date 2018-07-01 Valid until 2023-12-31</p>	<p>Ex d IIC T6</p>
	<p>IECEX</p> <p>Number IECEX PTB 11.0084X Date 2011-09-14</p>	<p>Ex d IIC T6, T5, T4 Gb Ex d e IIC T6, T5, T4 Gb Ex tb IIIC T80°C Db IP66</p>
	<p>INMETRO</p> <p>Number Date Valid until</p>	<p>Ex db IIC T* Gb Ex db eb IIC T* Gb Ex db [ia Ga] IIC T6 Gb Ex ia IIC T6 Ga Ex tb IIIC T80 °C Db</p>
	<p>KCS</p> <p>Number 13-KB4BO-0036 Date 2013-01-31 Valid until 2023-01-31</p>	<p>Ex d IIC T6/T5/T4</p>
	<p>TR CMU 1055</p> <p>Number ZETC/35/2021 Date 2021-07-26 Valid until 2024-07-25</p>	<p>II 2G Ex db IIC T6 Gb II 2G Ex db eb IIC T6 Gb II 2G Ex db [ia Ga] IIC T6 Gb II 2G Ex ia IIC T6 Ga II 2D Ex tb IIIC T80 °C Db IP66</p>
	<p>CSA</p> <p>Number 1709815 Date 2005-10-04</p>	<p>Class I, Zone 1, Group IIB+H2 T4...T6 Class I, Div. 1+2, Groups B, C, D T4...T6 Class II, Div. 1, Groups E, F, G</p>
-323	<p>FM</p> <p>Number 3024956 Date 2006-01-30</p>	<p>Class I, Div. 1+2, Groups B, C, D Class I, Zone 1, Groups IIB+H2 Class I, Div. 1+2 Groups E, F, G; Class III</p>

Design and principle of operation

Type	Certification		Type of protection/comments	
3731	-324		RU C-DE.	
			Number	HA65.B.00510/20
Date	2020-03-18			
		Valid until	2025-03-18	
3731	-327		Number	TC17747
			Date	2021-09-12
			Valid until	2024-09-11
			1 Ex d IIC T6/T5/T4 Gb X Ex tb IIIC T 80 °C Db X	
			Ex d IIC T6	

3.6 Dimensions in mm

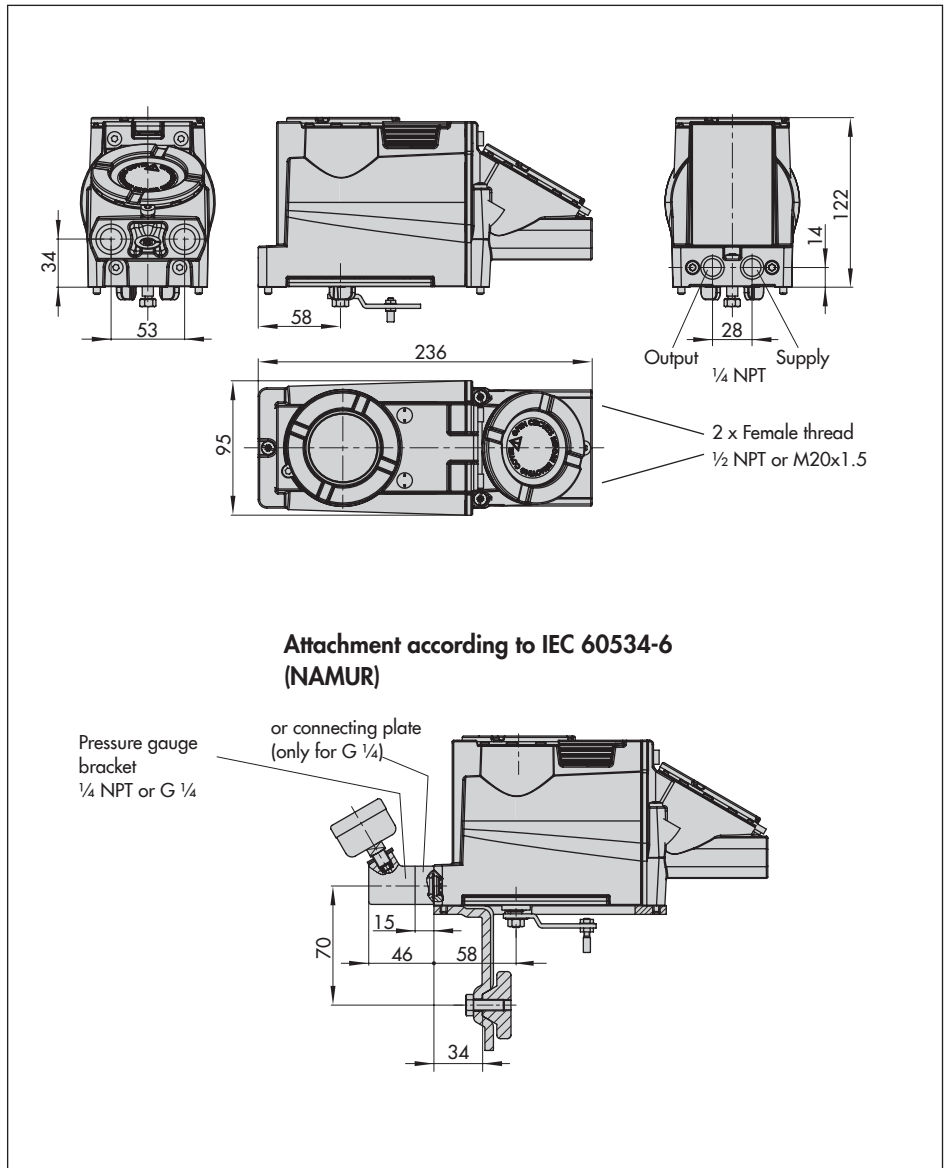

Attachment to rotary actuators according to VDI/VDE 3845

Fixing level 1, AA1 to AA4 size, see section 3.7

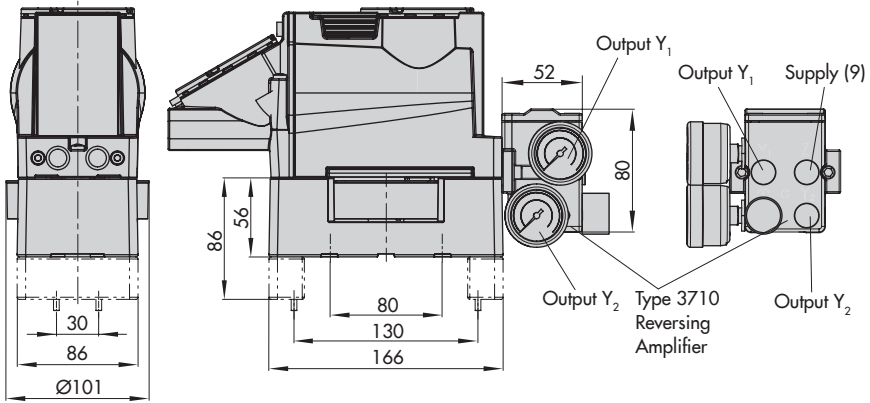

3.7 Fixing levels according to VDI/VDE 3845 (September 2010)

Size	A	B	C	Ød	M _{min}	D ¹⁾
AA0	50	25	15	5.5 for M5	66	50
AA1	80	30	20	5.5 for M5	96	50
AA2	80	30	30	5.5 for M5	96	50
AA3	130	30	30	5.5 for M5	146	50
AA4	130	30	50	5.5 for M5	146	50
AA5	200	50	80	6.5 for M6	220	50

¹⁾ Flange type F05 acc. to DIN EN ISO 5211

4 Measures for preparation

After receiving the shipment, proceed as follows:

1. Check the scope of delivery. Compare the shipment received with the delivery note.
2. Check the shipment for transportation damage. Report any transportation damage.

4.1 Unpacking

! NOTICE

Risk of positioner damage due to foreign particles entering it.

Do not remove the packaging and protective film/protective caps until immediately before mounting and start-up.

1. Remove the packaging from the positioner.
2. Dispose of the packaging in accordance with the valid regulations.

4.2 Transporting

- Protect the positioner against external influences (e.g. impact).
- Protect the positioner against moisture and dirt.
- Observe transport temperature depending on the permissible ambient temperature (see technical data in section 3.5).

4.3 Storage

! NOTICE

Risk of positioner damage due to improper storage.

- Observe the storage instructions.
- Avoid long storage times.
- Contact SAMSON in case of different storage conditions or longer storage times.

Storage instructions

- Protect the positioner against external influences (e.g. impact, shocks, vibration).
- Do not damage the corrosion protection (coating).
- Protect the positioner against moisture and dirt. In damp spaces, prevent condensation. If necessary, use a drying agent or heating.
- Observe storage temperature depending on the permissible ambient temperature (see technical data in section 3.5).
- Store the positioner with the cover closed.
- Seal pneumatic and electrical connections.

5 Mounting and start-up

⚠ NOTICE

Risk of malfunction due to incorrect sequence of mounting, installation and start-up.

Observe the prescribed sequence.

→ Sequence:

1. Remove the protective caps from the pneumatic connections.

2. Mount the positioner on the valve.

→ Section 5.3 onwards

3. Perform pneumatic installation.

→ Section 5.9 onwards

4. Perform electrical installation.

→ Section 5.11 onwards

5. Perform settings.

→ Section 7 onwards

⚠ NOTICE

Excessively high pressures will damage the positioner.

For actuators with less than 240 cm² diaphragm area, install a signal pressure restriction (see accessories, Table 5).

5.1 Mounting orientation

⚠ NOTICE

Risk of damage to the positioner due to incorrect mounting position.

– *Do not mount the positioner with the back of the device facing upward.*

– *Do not seal or restrict the vent opening when the device is installed on site.*

→ Observe mounting position (see Fig. 3).

→ Do not seal or restrict the vent opening (see Fig. 2) when the device is installed on site.

5.2 Lever and pin position

The positioner is adapted to the actuator and to the rated travel by the lever on the back of the positioner and the pin inserted into the lever.

The travel tables on page 23 show the maximum adjustment range at the positioner. The travel that can be implemented at the valve is additionally restricted by the selected fail-safe position and the required compression of the actuator springs.

The positioner is equipped with the M lever (pin position 35) as standard (see Fig. 4).

On exchanging the lever:

→ Move the newly mounted lever once all the way as far as it will go in both directions to adapt it to the internal measuring lever.

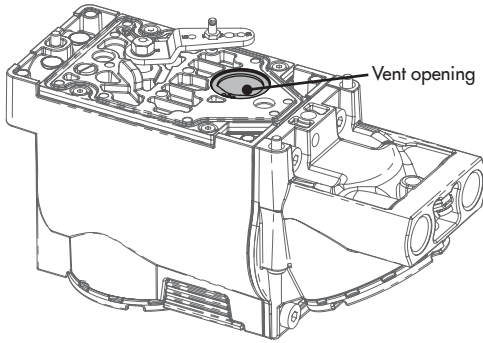

Fig. 2: Vent opening
(back of the positioner)

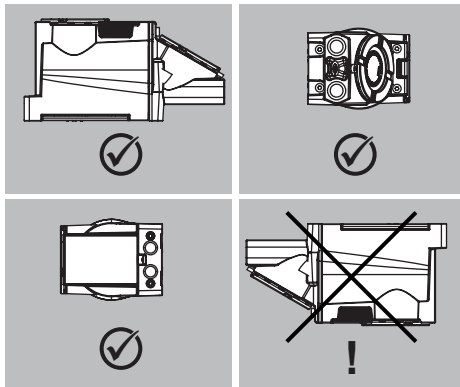

Fig. 3: Permissible mounting
positions

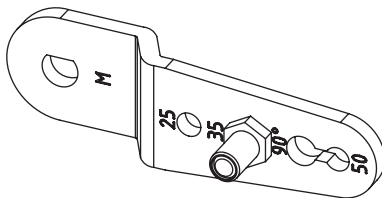

Fig. 4: M lever with pin position 35

5.3 Type 3277-5 Actuator

→ Required mounting parts and accessories: Table 1 on page 20.

Actuator (120 cm²)

If a solenoid valve or similar is additionally mounted to the actuator, observe the following instructions which differ from the instructions otherwise described:

- The switchover plate (9) is not used in this case.
- The signal pressure must be transmitted from the signal pressure output to the actuator over an additional connecting plate (accessories, order no. 1400-6820).
- Do not remove the screw plug (4) on the back.

Depending on the type of positioner attachment, the signal pressure is routed either left or right of the yoke through a hole to the actuator diaphragm.

1. Refer to Fig. 5 to select the symbol to match the required fail-safe position and how the positioner is attached:

Fail-safe action:

Actuator stem extends = Fail-close

Actuator stem retracts = Fail-open

Positioner attachment: left or right with view looking onto the switchover plate

2. Align the marking of the switchover plate (9) to the corresponding symbol and mount the plate on the actuator yoke.
3. Mount connecting plate (6) for required G ¼ connecting threads or pressure gauge bracket (7) with pressure gauges

on the positioner, making sure the two seals (6.1) are seated properly.

4. Remove screw plug (4) on the back of the positioner and seal the signal pressure output (38) at the positioner (or at the pressure gauge bracket (7) or connecting plate (6)) with the stopper (5) included in the accessories.
5. Place follower clamp (3) on the actuator stem, align it and screw tight so that the mounting screw is located in the groove of the actuator stem.
6. Mount cover plate (10) with narrow side of the cut-out (Fig. 5, on the left) pointing towards the signal pressure connection. Make sure that the gasket (14) points towards the actuator yoke.
7. **15 mm travel:** keep the follower pin (2) on the M lever (1) on the back of the positioner in the pin position 35 (delivered state).
7.5 mm travel: remove the follower pin (2) from the pin position 35, reposition it in the hole for pin position 25 and screw tight.
8. Insert the molded seal (15) into the groove of the positioner enclosure, pressing the four retaining rings over the enclosure screws and both fittings into the enclosure recesses.
9. Thread the bias spring (17) through the crosspiece underneath the lever (1) and push it into the hole in the enclosure. Push the lever (1) until it engages into place. Place the positioner on the cover plate (10) and fasten it using the three

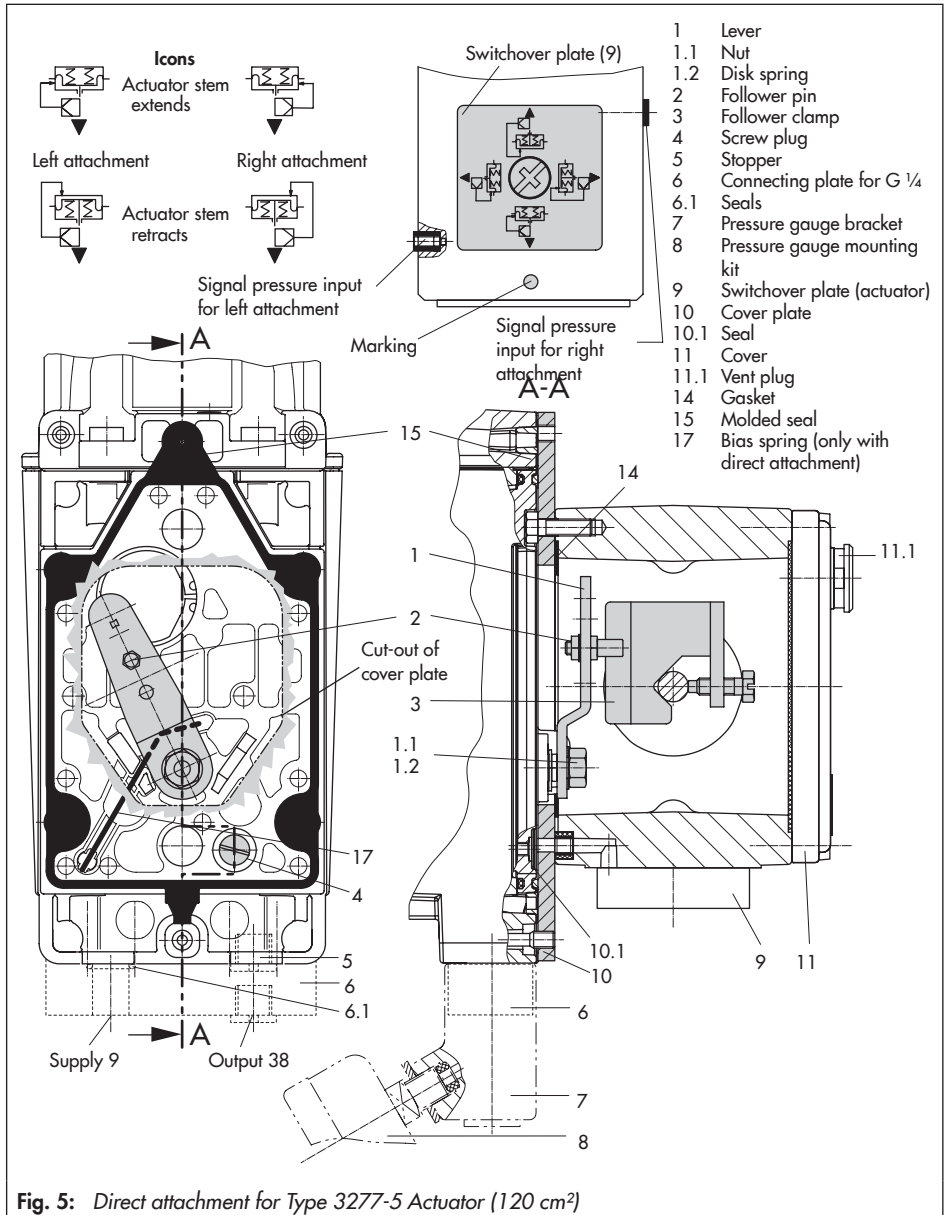

Mounting and start-up

fastening screws. Check whether the follower pin (2) rests on top of the follower clamp (3). The lever (1) must rest on the follower clamp with spring force.

During mounting, make sure that the seal (10.1) is inserted in the borehole of the cover plate.

10. Mount cover (11) on the other side. Make sure that the vent plug (11.1) is located at the bottom when the control valve is installed to allow any condensed water that collects to drain off.

5.4 Type 3277 Actuator

→ Required mounting parts and accessories: Table 2 on page 20.

Actuators with 175 to 750 cm² effective areas

Mount the positioner on the yoke as shown in Fig. 6. The signal pressure is routed to the actuator over the connection block (12), for actuators with fail-safe action "actuator stem extends" internally through a hole in the valve yoke and for "actuator stem retracts" through an external pipe.

1. Place follower clamp (3) on the actuator stem, align it and screw tight so that the mounting screw is located in the groove of the actuator stem.
2. Mount cover plate (10) with narrow side of the cut-out (Fig. 6, on the left) pointing towards the signal pressure connection. Make sure that the gasket (14) points towards the actuator yoke.
3. **Actuators (355, 700 and 750 cm²):**

Remove the follower pin (2) from the pin position 35 on M lever (1), reposition it in the hole for pin position 50 and screw tight.

Actuators (175 to 350 cm²) with 15 mm travel: the follower pin (2) remains in pin position 35 (delivered state).

4. Insert the molded seal (15) into the groove of the positioner enclosure, pressing the four retaining rings over the enclosure screws and both fittings into the enclosure recesses.
5. Thread the bias spring (17) through the crosspiece underneath the lever (1) and push it into the hole in the enclosure. Push the lever (1) until it engages into place. Place the positioner on the cover plate (10) and fasten it using the three fastening screws. Check whether the follower pin (2) rests on top of the follower clamp (3). The lever (1) must rest on the follower clamp with spring force.
6. Make sure that the tip of the gasket (16) projecting from the side of the connection block is positioned to match the actuator symbol for the actuator's fail-safe action "actuator stem extends" or "actuator stem retracts". If this is not the case, unscrew the three fastening screws and lift off the cover. Turn the gasket (16) by 180° and re-insert it. The old connection block version (Fig. 6, bottom) requires the switch plate (13) to be turned to align the actuator symbol with the arrow marking.
7. **Actuators (175 cm²):** unscrew the filter from the signal pressure input and first

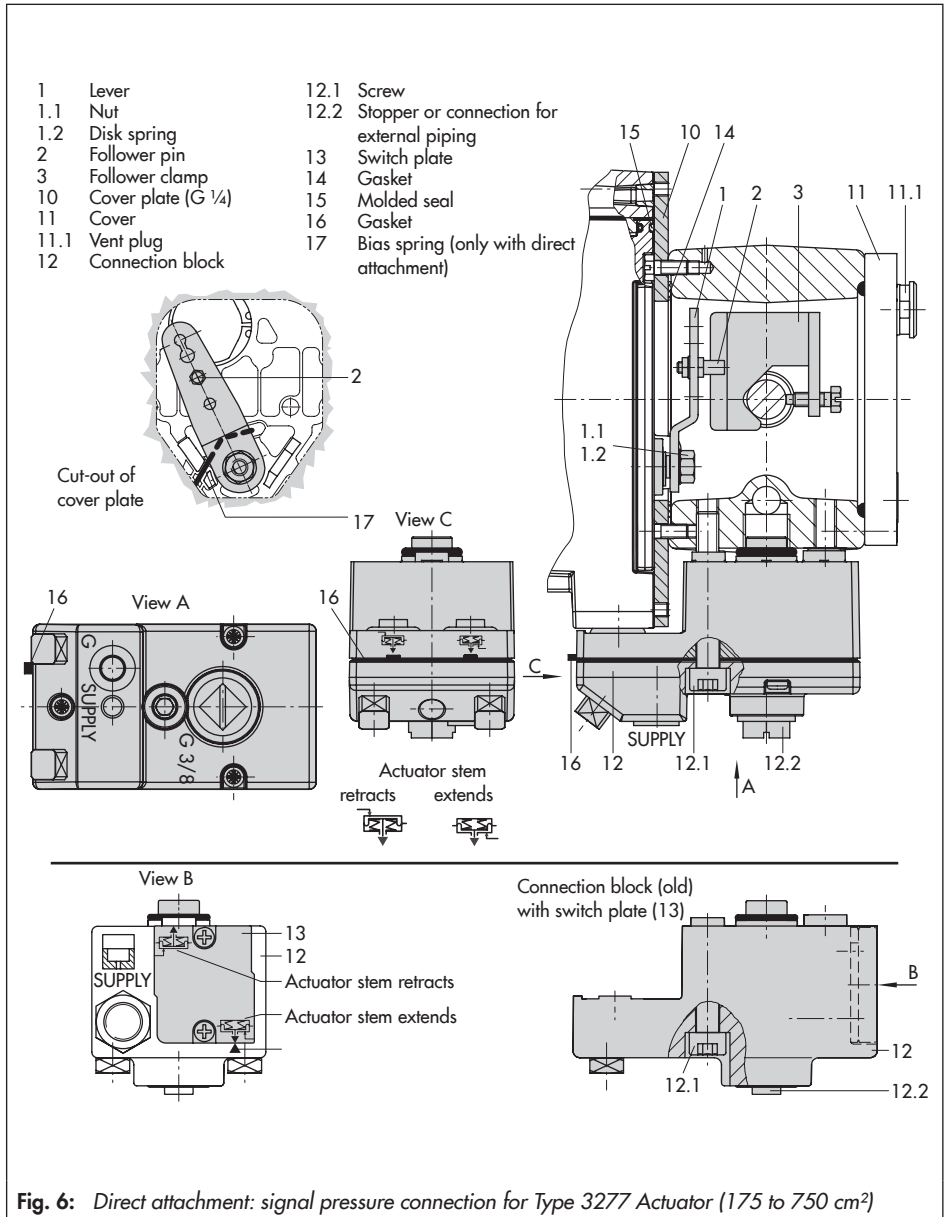

Mounting and start-up

screw the screw restriction (accessories order no. 1400-6964/item no. 0390-1424) into the signal pressure input before screwing the filter back into the input.

- Place the connection block (12) with the associated seals against the positioner and the actuator yoke and fasten using the screw (12.1). For actuators with fail-safe action "actuator stem retracts", additionally remove the stopper (12.2) and mount the external signal pressure pipe.
- Mount cover (11) on the other side. Make sure that the vent plug (11.1) faces the back when the control valve is installed to allow any condensed water that collects to drain off.

5.5 Attachment according to IEC 60534-6 (NAMUR)

→ Required mounting parts and accessories: Table 3 on page 21.

The positioner is attached to the control valve using a NAMUR bracket (10).

- 175 cm² actuators:** unscrew the filter from the signal pressure input and first screw the screw restriction (accessories order no. 1400-6964/item no. 0390-1424) into the signal pressure input before screwing the filter back into the input.
- 120 to 750 cm² actuators:** screw the two bolts (14) to the bracket (9.1) of the stem connector (9), place the follower plate (3) on top and use the screws (14.1) for fastening.

2800 cm² and 1400 cm² actuators (120 mm travel):

- For a travel of 60 mm or smaller, screw the longer follower plate (3.1) directly to the stem connector (9).
 - For a travel larger than 60 mm, mount the bracket (16) first and then the follower plate (3) to the bracket together with the bolts (14) and screws (14.1).
- Mount NAMUR bracket (10) to the control valve as follows:
 - For attachment to the NAMUR rib, use an M8 screw (11), shim and toothed lock washer directly in the yoke hole.
 - For attachment to valves with rod-type yokes, use the two U-bolts (15) around the yoke. Align the NAMUR bracket (10) so that the slot of the follower plate (3/3.1) is centrally aligned with the NAMUR bracket at mid valve travel.
 - Mount connecting plate (6) for required G ¼ connecting threads or pressure gauge bracket (7) with pressure gauges on the positioner, making sure the two seals (6.1) are seated properly.
 - For actuators with less than 240 cm² diaphragm area, we recommend screwing a screw restriction (accessories order no. 1400-6964/item no. 0390-1424) into the signal pressure output.
 - Select required lever size (1) M, L or XL and pin position according to the actuator size and valve travel listed in the travel table on page 23.

M lever with pin position 25 or 50:

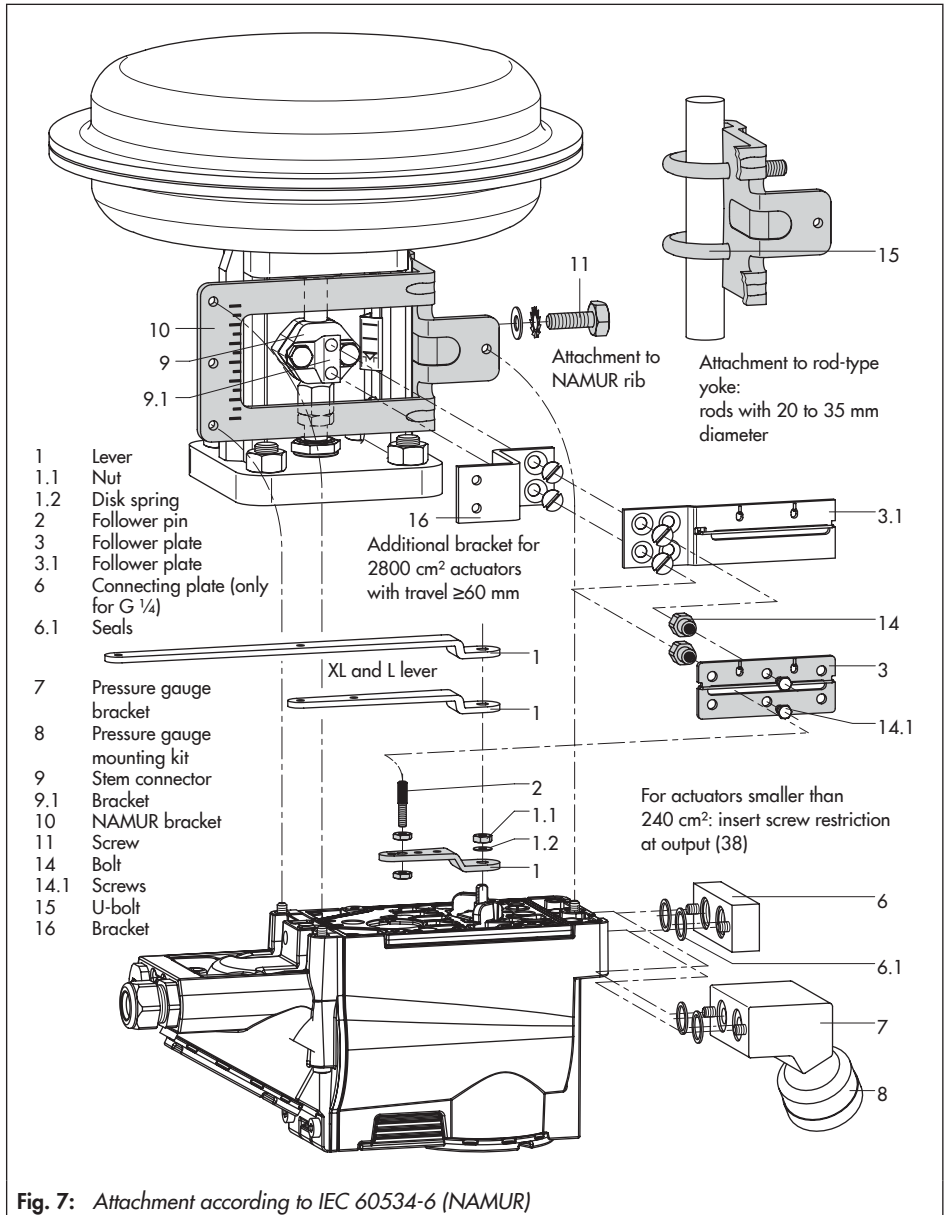

Mounting and start-up

- Remove the follower pin (2) from the pin position 35, reposition it in the required hole and screw tight.
- L or XL lever:**
- Unscrew the standard M lever from the positioner shaft.
 - Mount the long follower pin (2) from the mounting kit in the pin position of the required level (1) (as listed in the table).
 - Place the lever (1) on the shaft of the positioner and fasten it tight using the disk spring (1.2) and nut (1.1).
 - Move lever once all the way as far as it will go in both directions.
7. Place positioner on the NAMUR bracket in such a manner that the follower pin (2) rests in the slot of the follower plate (3/3.1). Adjust the lever (1) correspondingly. Screw the positioner to the NAMUR bracket using the three fastening screws.

5.6 Attachment to Type 3510 Micro-flow Valve

→ Required mounting parts and accessories: Table 3 on page 21.

The positioner is attached to the valve yoke using a bracket.

1. Mount the travel indication scale (accessories) to the outer side of the yoke using the hex screws (12.1), ensuring that the scale is aligned with the stem connector.
2. Fasten the bracket (9.1) to the stem connector.
3. Screw the two bolts (9.2) to the bracket (9.1) of the stem connector (9), place the follower plate (3) on top and use the screws (9.3) for fastening.
4. Fasten the hex bar (11) onto the outer side of yoke by screwing the M8 screws (11.1) directly into the holes on the yoke.
5. Fasten the bracket (10) to the hex bar (11) using the hex screw (10.1), shim and tooth lock washer.
6. Mount connecting plate (6) for required G ¼ connecting thread or pressure gauge bracket (7) with pressure gauge on the positioner, making sure the two seals (6.1) are seated properly.
7. Screw the screw restriction (accessories order no. 1400-6964/item no. 0390-1424) into the signal pressure output of the positioner (or the output of the pressure gauge bracket or connecting plate).
8. Unscrew the standard M lever (1) including follower pin (2) from the positioner shaft.
9. Take the S lever (1) and screw the follower pin (2) in the hole for pin position 17.
10. Place the S lever on the positioner shaft and screw tight using the disk spring (1.2) and nut (1.1). Move lever once all the way as far as it will go in both directions.
11. Place positioner on the bracket (10) in such a manner that the follower pin slides into the groove of the follower pin (3). Adjust the lever (1) correspondingly. Screw the positioner to the bracket (10) using both its screws.

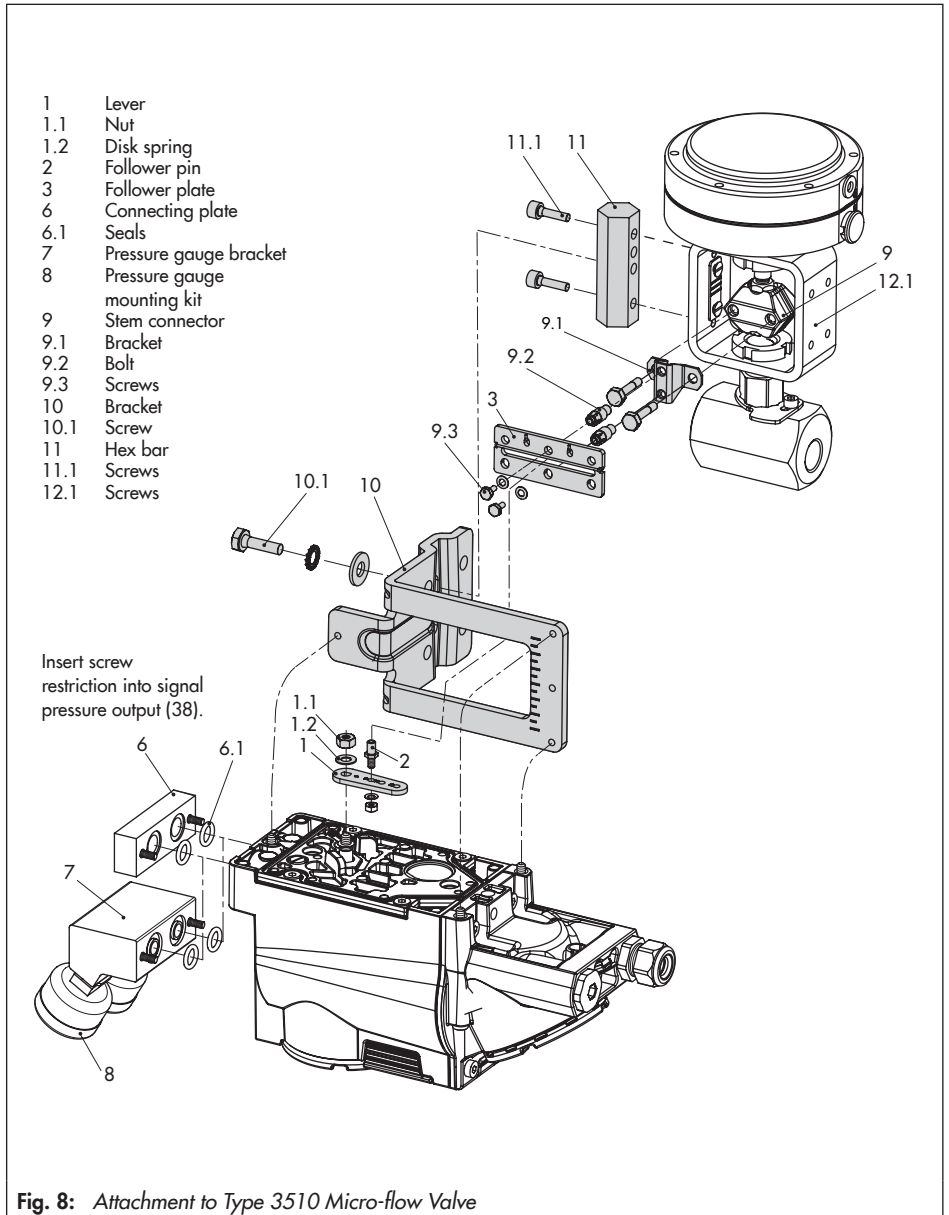

Fig. 8: Attachment to Type 3510 Micro-flow Valve

5.7 Attachment to rotary actuators

➔ Required mounting parts and accessories: Table 4 on page 22.

Both mounting kits contain all the necessary mounting parts. The parts for the actuator size used must be selected from the mounting kit. Prepare actuator and mount possibly required adapter supplied by the actuator manufacturer.

1. Mount the housing (10) onto the rotary actuator. In case of VDI/VDE attachment, place spacers (11) underneath, if necessary.
2. For **SAMSON Type 3278 and VETEC S160 Rotary Actuators**, fasten the adapter (5) onto the free end of the shaft. For VETEC R Actuator, place on the adapter (5.1). Place adapter (3) onto **Type 3278, VETEC S160 and VETEC R Actuators**. For **VDI/VDE version**, this step depends on the actuator size.
3. Stick adhesive label (4.3) onto the coupling in such a manner that the yellow part of the sticker is visible in the window of the housing when the valve is OPEN. Adhesive labels with explanatory symbols are enclosed and can be stuck on the housing, if required.
4. Fasten coupling wheel (4) on the slotted actuator shaft or adapter (3) using screw (4.1) and disk spring (4.2).
5. Unscrew the standard follower pin (2) from the positioner's M lever (1). Attach the follower pin (\varnothing 5 mm) included in the mounting kit to pin position 90° .
6. Mount connecting plate (6) for required G $\frac{1}{4}$ connecting thread or pressure gauge bracket (7) with pressure gauges on the positioner. Make sure that the two seals (6.1) are seated properly. Double-acting springless rotary actuators require the use of a reversing amplifier on the connection side of the positioner housing (see section 5.8).
7. For actuators with a volume of less than 300 cm³, screw the screw restriction (accessories order no. 1400-6964/item no. 0390-1424) into the signal pressure output of the positioner (or the output of the pressure gauge bracket or connecting plate).
8. Place positioner on housing (10) and screw it tight. Taking the actuator's direction of rotation into account, adjust lever (1) so that it engages in the correct slot with its follower pin (Fig. 10).

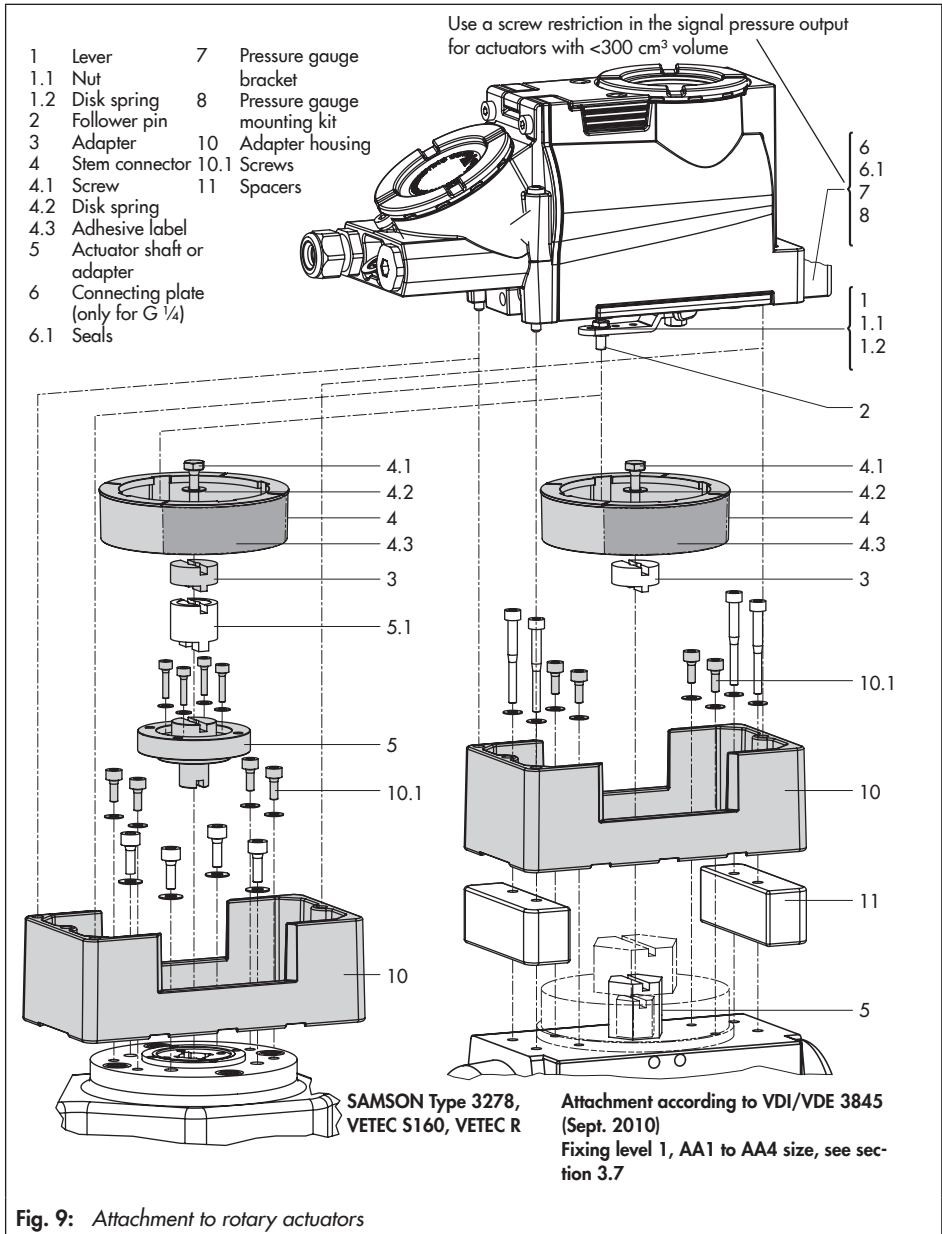
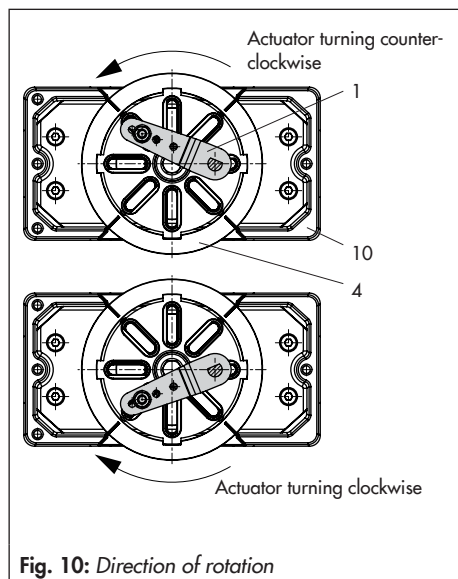

Fig. 9: Attachment to rotary actuators



5.8 Reversing amplifier for double-acting actuators

For the use with double-acting actuators, the positioner must be fitted with a reversing amplifier.



Tip

We recommend using the Type 3710 Reversing Amplifier (see *Mounting and Operating Instructions* ► EB 8392).

If a different reversing amplifier (item no. 1079-1118 or 1079-1119) is used, follow the mounting instructions described in section 5.8.1.

The following applies to all reversing amplifiers:

The signal pressure of the positioner is supplied at the output A_1 of the reversing amplifier. An opposing pressure, which equals the required supply pressure when added to the pressure at A_1 , is applied at output A_2 . The rule $A_1 + A_2 = Z$ applies.

A₁: Connect output A_1 to the signal pressure connection on the actuator that causes the valve to open when the pressure rises.

A₂: Connect output A_2 to the signal pressure connection on the actuator that causes the valve to close when the pressure rises.

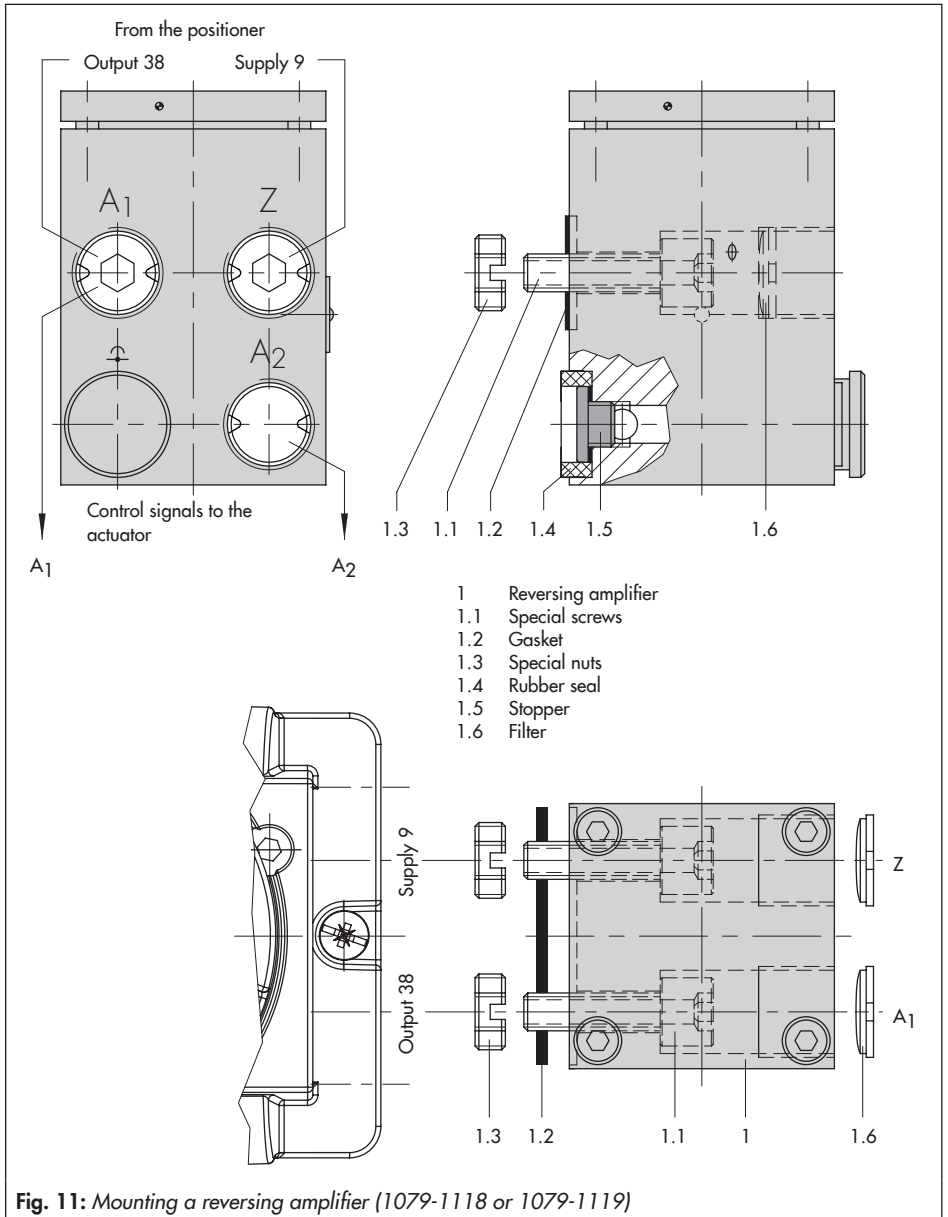

5.8.1 Reversing amplifier (1079-1118 or 1079-1119)

→ Do not unscrew the sealing plug (1.5) out of the reversing amplifier.

1. Screw the special nuts (1.3) from the accessories of the reversing amplifier into the boreholes of the positioner. Remove the rubber gasket (1.4).
2. Insert the gasket (1.2) into the recess of the reversing amplifier and slide both the hollowed special screws (1.1) into the connecting boreholes A₁ and Z.
3. Place the reversing amplifier (1) and screw tight using both the special screws (1.1).
4. Use a screwdriver (8 mm wide) to screw the enclosed filters (1.6) into the connection boreholes A₁ and Z.

Pressure gauge attachment

The mounting sequence shown in Fig. 11 remains unchanged. Screw a pressure gauge bracket onto the connections A₁ and Z.

Pressure gauge bracket	G ¼	1400-7106
	¼ NPT	1400-7107

Pressure gauges for supply air Z and output A₁ as listed in Accessories in section 3.3.

i Note

On start up of double-acting actuators, the following settings as described in section 7 must be made:

- Pressure limit (Code 16) = 'No'
 - Fail-safe position (Code 0) = 'AtO' (AIR TO OPEN)
-

5.9 Pneumatic connections

⚠ DANGER

Risk of fatal injury due to the formation of an explosive atmosphere.

Operators of the equipment must make sure that the operating medium cannot create potentially explosive atmospheres.

- ➔ Only use gases that are free of substances that could create a potentially explosive atmosphere if present in the medium (non-flammable gases as well as no oxygen or oxygen-enriched gases).

⚠ WARNING

Risk of injury by possible movement of exposed parts (positioner, actuator or valve) after connecting the signal pressure.

- ➔ Do not touch or block exposed moving parts.

ⓘ NOTICE

Incorrect connection of the supply air will damage the positioner and will lead to malfunction.

- ➔ Screw the screw fittings into the connecting plate, pressure gauge mounting block or connection block from the accessories.

ⓘ NOTICE

Risk of malfunction due to failure to comply with air quality requirements.

- ➔ Only use supply air that is dry and free of oil and dust.
- ➔ Read the maintenance instructions for upstream pressure reducing stations.
- ➔ Blow through all air pipes and hoses thoroughly before connecting them.

5.10 Connecting the supply air

ⓘ NOTICE

Risk of malfunction due to incorrect sequence of mounting, installation and start-up.

Observe the following sequence.

1. Remove the protective caps from the pneumatic connections.
2. Mount the positioner on the valve.
3. Connect the supply air.
4. Connect the electrical power.
5. Perform settings.

The screw fittings with ¼ NPT thread can be screwed directly into the positioner. In case G ¼ threaded connections are required, the fittings must be screwed into the connecting plate (6) or pressure gauge mounting block or connection block available from the accessories.

Customary fittings for metal or copper tubing or plastic hoses can be used.

- ➔ Read instructions in section 5.9.

5.10.1 Signal pressure connection

The signal pressure connection depends on how the positioner is mounted onto the actuator:

Type 3277 Actuator

→ The signal pressure connection is fixed.

Attachment according to IEC 60534-6 (NAMUR)

- For "actuator stem retracts" fail-safe action: connect the signal pressure to the connection on the bottom of the actuator.
- For "actuator stem extends" fail-safe action: connect the signal pressure to the connection on top of the actuator.

Attachment to rotary actuators

- For rotary actuators, the manufacturer's specifications for connection apply.

5.10.2 Signal pressure reading



Tip

To monitor the supply air and signal pressure, we recommend mounting pressure gauges (see accessories in section 3.3).

Mounting the pressure gauges:

- See sections 5.5 and Fig. 7

5.10.3 Supply pressure

The maximum input pressure (supply pressure) is:

- Max. 7 bar for Types 3731-321/-327
- Max. 6 bar for Type 3731-323

The required supply air pressure depends on the bench range and the actuator's direction of action (fail-safe action).

The bench range is written on the nameplate either as the bench range or signal pressure range depending on the actuator. The direction of action is marked FA or FE or by a symbol.

Actuator stem extends FA (AIR TO OPEN)

Fail-close (for globe and angle valves):

- Required supply pressure = Upper bench range value + 0.2 bar, at least 1.4 bar.

Actuator stem retracts FE (AIR TO CLOSE)

Fail-open (for globe and angle valves):

For tight-closing valves, the maximum signal pressure $p_{st_{max}}$ is roughly estimated as follows:

$$p_{st_{max}} = F + \frac{d^2 \cdot \pi \cdot \Delta p}{4 \cdot A} \text{ [bar]}$$

d = Seat diameter [cm]

Δp = Differential pressure across the valve [bar]

A = Actuator area [cm²]

F = Upper bench range value of the actuator [bar]

If there are no specifications, calculate as follows:

- Required supply pressure = Upper bench range value + 1 bar

5.10.4 Signal pressure (output)

The signal pressure at the output (38) of the positioner can be restricted to 1.4 bar, 2.4 bar or 3.7 bar in Code 16.

The limitation is not activated by default [No].

5.11 Electrical connections

⚠ DANGER

Risk of fatal injury due to the formation of an explosive atmosphere.

- For installation in hazardous areas, observe the relevant standards that apply in the country of use.

Standard applicable in Germany:
EN 60079-14 (VDE 0165, Part 1) Explosive Atmospheres – Electrical Installations Design, Selection and Erection.

Connection with type of protection Ex d according to EN 60079-1:

Connect the Type 3731-321 Positioner using suitable cable entries or conduit systems that comply with EN 60079-1 Explosive Atmospheres – Part 1: Equipment Protection by Flameproof Enclosures "d", Clauses 13.1 and 13.2 and for which a separate test certificate is available. Do not use cable glands and blanking plugs of simple construction.

- For installation according to the type of protection Ex db, seal cable entries left unused with plugs certified for this purpose.

Install the connecting cable properly so that it is protected against mechanical damage. If the temperature at the entry parts exceeds 70 °C, use a temperature-resistant connecting cable.

Include the positioner in the on-site equipotential bonding system.

Connection with type of protection Ex e according to EN 60079-7:

Cable entries and the blanking plug must be certified according to type of protection Ex e according to ATEX and possess a separate test certificate.

Use metal cable glands for ambient temperatures below –20 °C.

If more than one cable core is connected to the same terminal, make sure that each core is clamped adequately.

If it is not explicitly allowed in the documentation relating to the electrical equipment, two cables with different cross-sections may only be connected to one terminal after being secured with a common crimp sleeve.

Connection with type of protection Ex i according to EN 60079-11:

For connection to a certified, external intrinsically safe circuit, the terminal compartment of the positioner may be opened within the hazardous area.

Mounting and start-up

Only the terminal compartment is to be opened within the hazardous area to connect it to a certified intrinsically safe circuit.

- ➔ **Positioners that are connected to non-intrinsically safe circuits are no longer permitted to be used as intrinsically safe equipment.**
- ➔ **The degree of protection (IP rating) of the cable entries and the blanking plug must be the same as that of the positioner.**

Positioners according to CSA and FM requirements

- Use supply wires rated at least 90 °C.
- Caution keeping cover tight while circuits are live.
- Seal not required.

Cable entry

The threaded connection for the terminal compartment is designed with an M20x1.5 or ½ NPT thread.

The screw terminals are designed for wire cross-sections of 0.2 to 2.5 mm². Tighten by at least 0.5 Nm.

The wires for the set point must be connected to the enclosure terminals marked 'Signal' and are polarity insensitive.

- OVERLOAD appears on the display when the set point exceeds 22 mA.
- The positioner moves to the fail-safe position (SAFE) if the set point falls below 3.8 mA. LOW appears on the display as a warning when the set point falls below 3.7 mA.

Depending on the version, the positioner is equipped with an additional binary output, a forced venting function, a position transmitter or a binary input.

The position transmitter is operated on a two-wire circuit. The usual supply voltage is 24 V DC. Taking the resistance of the supply leads into account, the voltage at the position transmitter terminals can be between at least 11 and 35 V DC at the maximum (reverse polarity protection, see section 3.5 static destruction limit).

⚠ WARNING

Specified degree of protection is not achieved due to insufficient sealing of the terminal compartment.

- ➔ *Only operate the positioner with sealed cable entries and locked cover.*

⚠ WARNING

Loss of the explosion protection due to damage to the cover's thread and/or the connecting thread.

- ➔ *Do not open devices with flameproof enclosures while they are energized.*
 - ➔ *Observe explosion protection regulations.*
-

5.11.1 Connecting the electrical supply

1. Unscrew the cover.
2. Guide the wires through the side cable entry to the terminal compartment using a cable gland or conduit system.
3. Connect wires to the terminals as shown in the wiring diagram to the enclosure terminals (see Fig. 15 on page 53).
4. Check the O-ring for damage and replace it, if necessary.
5. Screw on the cover as far as it will go. Unscrew the cover until the first possible safety position (notch) is reached.
6. Unscrew the cap screw to lock the cover.

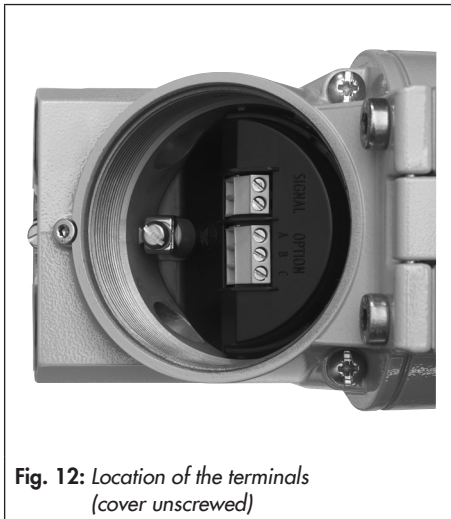

Fig. 12: Location of the terminals (cover unscrewed)

5.11.2 Establishing communication

Communication between computer and positioner using an FSK modem or handheld communicator is based on the HART® protocol.

Viator FSK modem

RS-232	No explosion protection	Order no. 8812-0130
--------	-------------------------	---------------------

USB	No explosion protection	Order no. 8812-0132
-----	-------------------------	---------------------

If the load impedance of the controller or control station is too low, an isolation amplifier must be connected between controller and positioner.

Using the HART® protocol, all connected control room and field units can be addressed individually using a point-to-point connection or the standard (multidrop) bus.

Point-to-point:

The bus address/polling address must always be set to zero (0).

Standard bus (multidrop):

In the standard bus (multidrop) mode, the positioner follows the analog current signal (set point) in the same way as for point-to-point communication. This operating mode is, for example suitable for split-range operation of positioners (series connection). The bus address/polling address has to be within a range of 1 to 15.

Mounting and start-up

i Note

Communication errors may occur when the process controller/control station output is not HART®-compatible.

For adaptation, the Z box (order no. 1170-2374) can be installed between output and communication interface. At the Z box a voltage of approx. 330 mV is released (corresponds to 16.5 Ω at 20 mA).

Alternatively, a 250 Ω resistor can be connected in series and a 22 μF capacitor can be connected in parallel to the analog output. The load for the controller output will increase as a result.

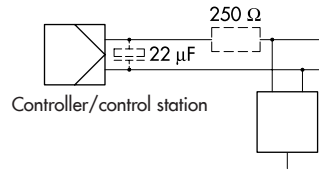

Fig. 13: Adapting the output signal

Accessories for electrical connection

→ See Table 6 on page 22.

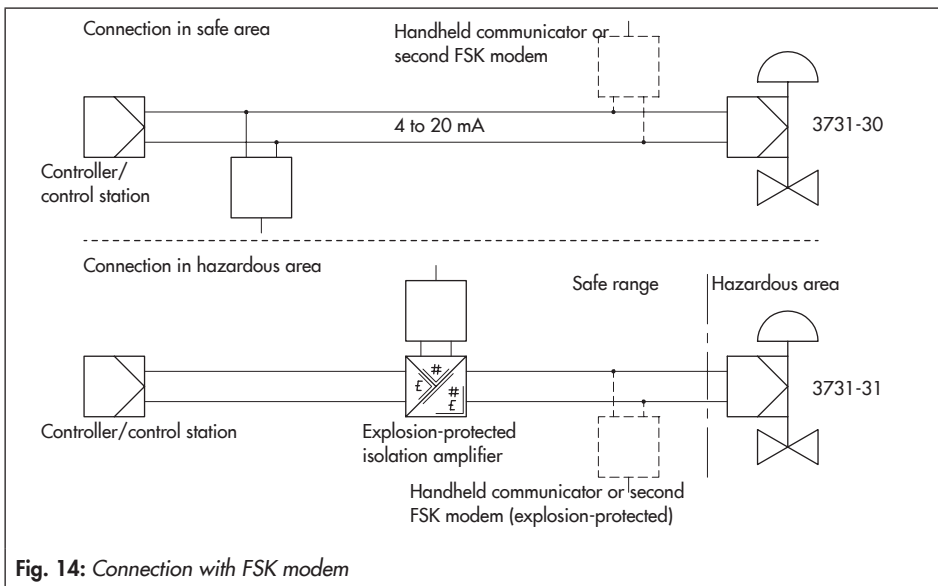
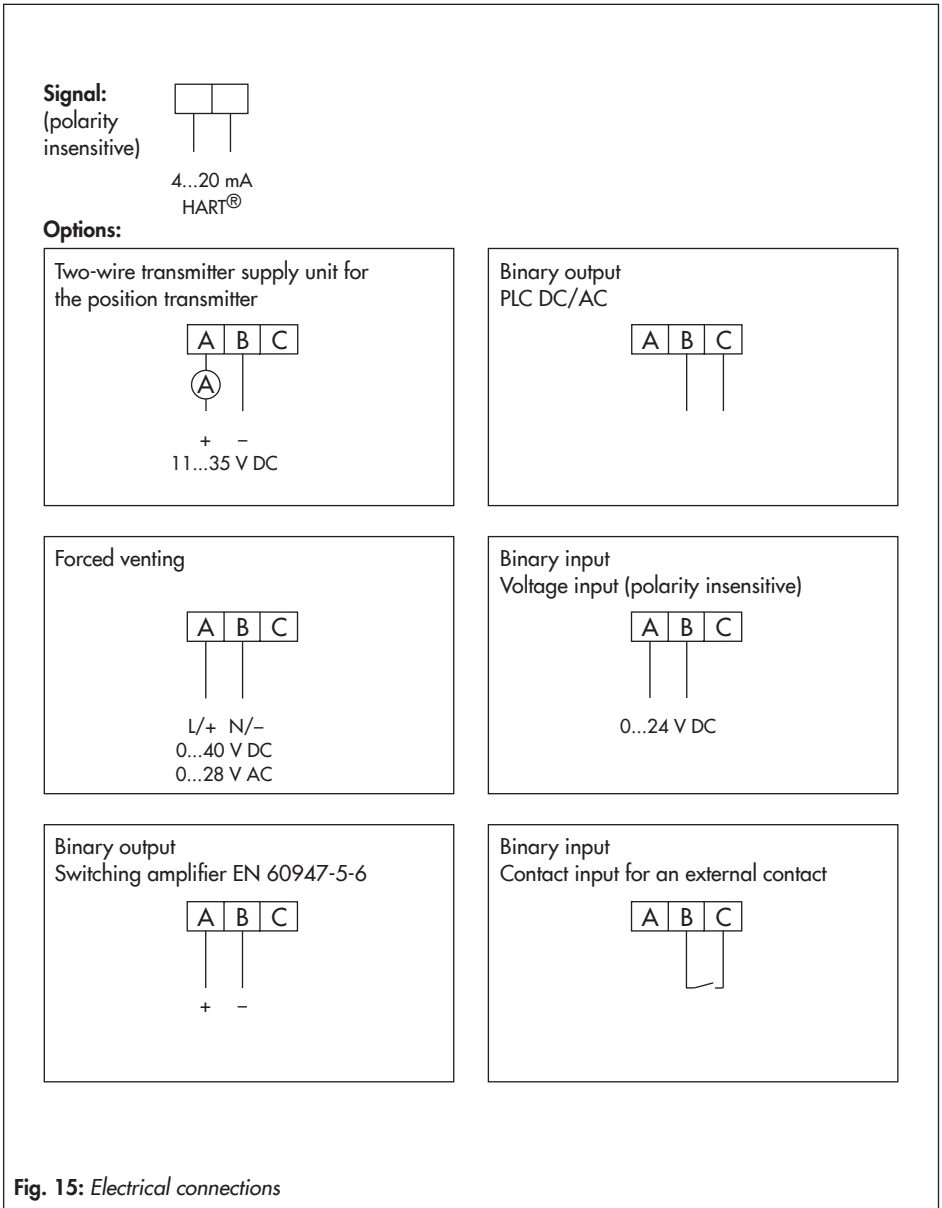

Fig. 14: Connection with FSK modem



6 Operating controls and readings

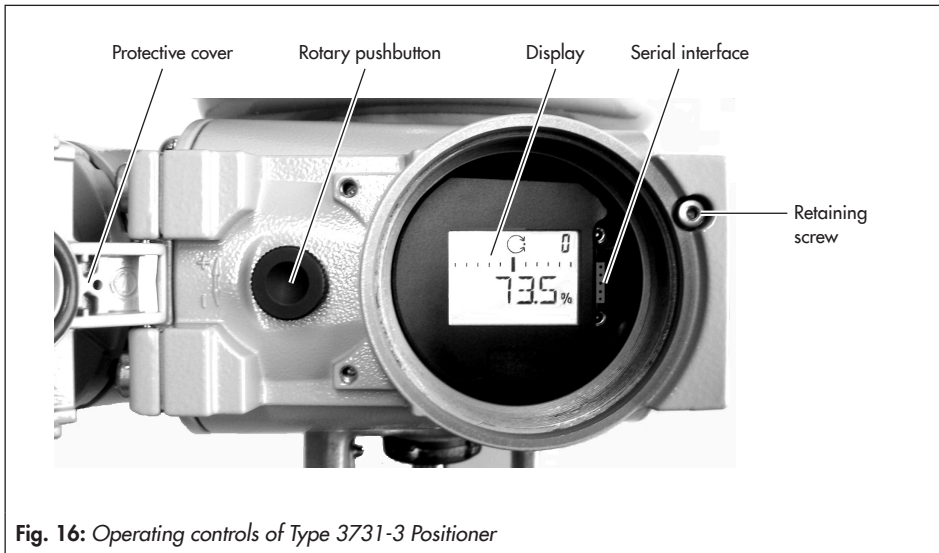

Fig. 16: Operating controls of Type 3731-3 Positioner

6.1 Rotary pushbutton

The rotary pushbutton (⊙) is located underneath the front protective cover.

The device is operated on site using the rotary pushbutton:

Turn ⊙: select codes and values

Press ⊙: confirm setting

6.2 Serial interface

The serial interface connection is located underneath the display cover: unscrew and remove the retaining screw before unscrewing the display cover.

⚠ WARNING

An open display cover will render the explosion protection unsafe.

→ Only open the display cover in atmospheres that are not potentially explosive.





The positioner must be supplied with at least 4 mA.

The local SAMSON SSP interface of the positioner needs to be connected over an adapter (see Table 5 on page 22) to the RS-232 or USB port of the computer before the TROVIS-VIEW software can be used.

6.3 Reading



Icons assigned to certain codes, parameters and functions are indicated on the display (see Fig. 17).

Operating modes:

-  Manual mode (see section 8.2.1)
The positioner follows the manual set point (Code 1) instead of the mA signal.
-  blinks: The positioner is not initialized. Operation only possible over manual set point (Code 1).
-  Automatic mode (see section 8.2.1)
The positioner is in closed-loop operation and follows the mA signal.
-  **Fail-safe position** (see section 8.2.2)
The positioner vents the output. The valve moves to the mechanical fail-safe position.
- **Bar graph**
In manual and automatic modes, the bars indicate the set point deviation that depends on the sign (+/-) and the value. One bar element appears per 1 % set point deviation. If the positioner has not been initialized, ( blinks on the display), the bar graph indicates the lever position in degrees in relation to the mid-axis. One bar element corresponds to approximately a 5° angle of rotation. The fifth bar element blinks (reading > 30°) if the permissible angle of rotation

has been exceeded. Lever and pin position must be checked.

- Status messages

-  : Maintenance alarm
-  : Maintenance demanded/Maintenance required
-  blinks: Out of specification

These icons indicate that an error has occurred. A classified status can be assigned to each error. Classifications include 'No message', 'Maintenance required', 'Maintenance demanded', 'Out of specification' and 'Maintenance alarm' (see section 8.3 on EXPERTplus valve diagnostics).

- Enable configuration

This indicates that the codes marked with an asterisk (*) in the code list (see section 12.2) are enabled for configuration (see section 8.1).

Operating controls and readings

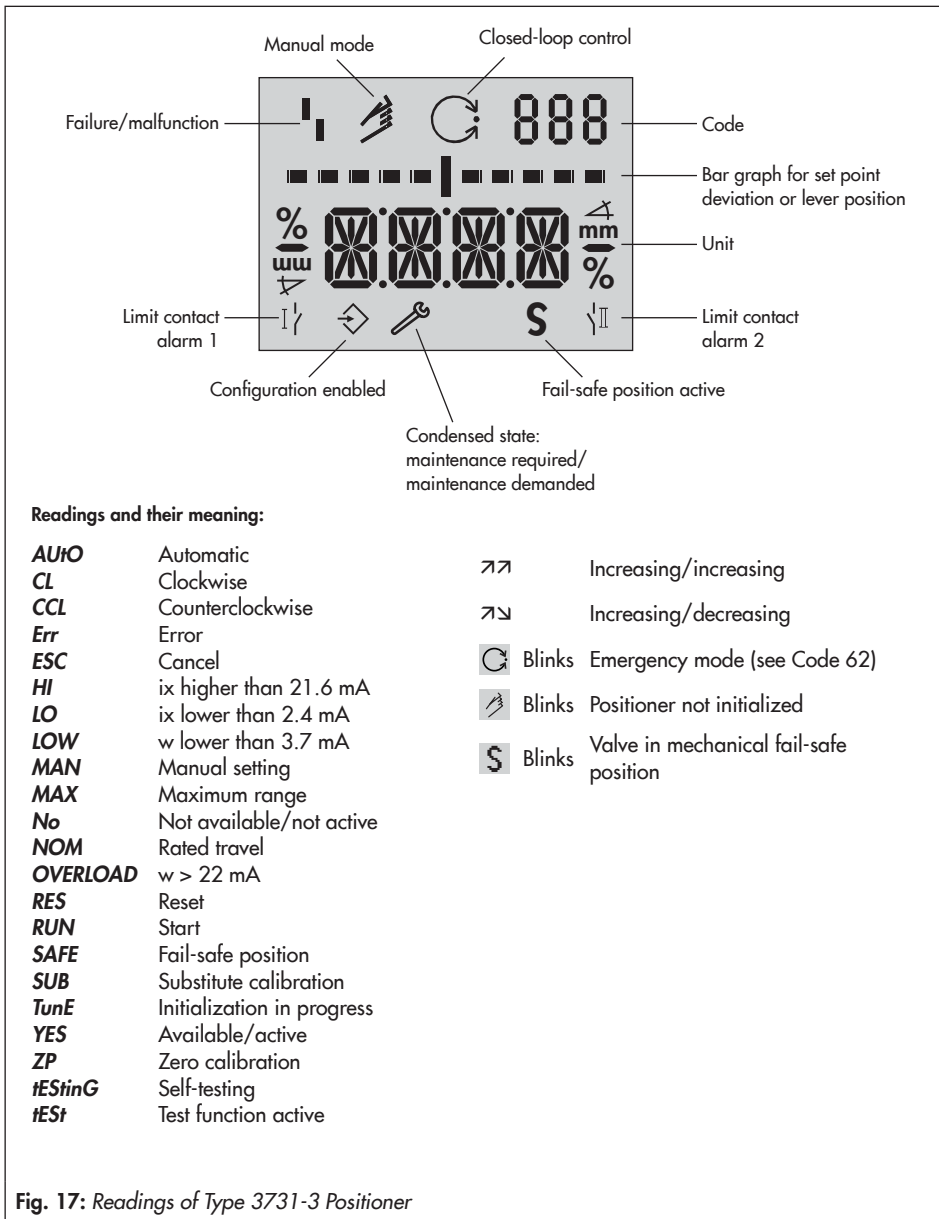

Fig. 17: Readings of Type 3731-3 Positioner

6.4 HART® communication

The positioner must be operated with at least 3.8 mA.

A DTM file (Device Type Manager) conforming to the Specification 1.2 is available for communication. This allows the device, for example to be run with the PACTware user interface. All the positioner's parameters are accessible over the DTM and the user interface.

i Note

If complex functions are started in the positioner, which require a long calculation time or lead to a large quantity of data being saved in the volatile memory of the positioner, the alert 'busy' is issued by the DTM file. This alert is not an error message and can be simply confirmed.

Write protection

- The write access for HART® communication can be disabled over Code **47**. This function can only be enabled locally at the positioner. Write access is enabled by default.
- The on-site operation can be locked over HART® communication. In this case, HART blinks on the display when Code **3** is selected. This locking function can only be disabled over HART® communication. On-site operation is enabled by default.

6.4.1 Dynamic HART® variables

The HART® specification defines four dynamic variables consisting of a value and an engineering unit. These variables can be assigned to device parameters as required. The universal HART® command 3 reads the dynamic variables out of the device. This allows manufacturer-specific parameters to also be transferred using a universal command.

In the Type 3731-3 Positioner, the dynamic variables can be assigned by the DD or in TROVIS-VIEW [Settings > Operation unit] as shown in Table 12 on page 58.

Operating controls and readings

Table 12: *Dynamic HART® variables assignment*

Variable	Meaning	Unit
Set point		%
Direction of action set point		%
Set point after transit time specification		%
Valve position		%
Set point deviation e		%
Absolute total valve travel		–
Binary input status	0 = Not active 1 = Active 255 = –/–	–
Internal solenoid valve/forced venting status	0 = De-energized 1 = Energized 2 = Not installed	–
Condensed state	0 = No message 1 = Maintenance required 2 = Maintenance demanded 3 = Maintenance alarm 4 = Out of specification 7 = Function check	–
Temperature		°C

7 Operating the positioner

NOTICE

Risk of malfunction due to incorrect sequence of mounting, installation and start-up.

Observe the following sequence.

1. Remove the protective caps from the pneumatic connections.
2. Mount the positioner on the valve.
3. Connect the supply air.
4. Connect the electrical power.
5. Perform settings.

Reading after connecting the electrical power supply:



tESinG runs across the display as well as the wrench icon and the hand icon blink on the display when the positioner has not been initialized. The reading indicates the lever position in degrees in relation to the mid-axis.

Code 0 is displayed when a positioner has been initialized. The positioner is in the last active operating mode.

7.1 Adapting the display direction

The display contents can be turned by 180° to adapt the display reading to the actuator's mounting situation. If the displayed data appear upside down, proceed as follows:

1. Turn until Code 2 appears.
2. Press , the code number 2 blinks.
3. Turn and select the desired reading direction.
4. Press to confirm.

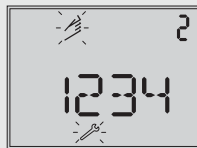

Reading direction for right attachment of pneumatic connections

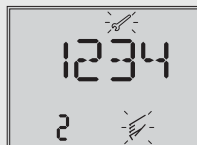

Reading direction for left attachment of pneumatic connections

7.2 Limiting the signal pressure





If the maximum actuator force may cause damage to the valve, the signal pressure must be limited.

➔ Do not activate pressure limitation for double-acting actuators (AIR TO OPEN (ATO) fail-safe position). Default setting is 'No'.

Enable configuration at the positioner before limiting the signal pressure.

Enable configuration:





Configuration is locked again if no settings are entered within 120 seconds.

1. Turn  until Code **3** appears (reading: **No**).
2. Press , the code number **3** blinks.
3. Turn  until **YES** appears.
4. Press  to confirm (reading: ).



Enable configuration
Default: No

Limit the signal pressure:

1. Turn  until Code **16** appears.
2. Press , the code number **16** blinks.
3. Turn  until the required pressure limit (1.4/2.4/3.7 bar) appears.
4. Press  to confirm.

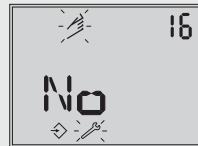





Pressure limit
Default: No

7.3 Checking the operating range of the positioner

To check the mechanical attachment, the valve should be moved through the operating range of the positioner in the  manual mode (MAN) with the manual set point w.





Select manual mode (MAN):

1. Turn  until Code **0** appears.
2. Press , the code number **0** blinks.
3. Turn  until **MAN** appears.
4. Press . The positioner changes to the manual mode.



Operating mode
Default: MAN

Check the operating range:

1. Turn  until Code **1** appears.
2. Press , the code number **1** and  icon blink.
3. Turn  until the pressure in the positioner builds up and the control valve moves to its final positions so that the travel/angle can be checked.
The angle of rotation of the lever on the back of the positioner is indicated.



Manual set point w
(current angle of
rotation is indicated)

A horizontal lever (mid position) is equal to 0°.

To ensure the positioner is working properly, the outer bar elements must not blink while the valve is moving through the operating range. Exit the manual mode by pressing the rotary pushbutton.

The permissible range has been exceeded when the displayed angle is more than 30° and the outer right or left bar element blinks. The positioner goes to the fail-safe position (**SAFE**).

➔ After canceling the fail-safe position (SAFE) (see section 8.2.2), check that the lever and pin position are correct (see section 5).

⚠ WARNING

Risk of personal injury due to moving parts on the valve. Injury to hands or fingers is possible if they are inserted into the valve.

- ➔ While the process is running, do not insert hands or fingers into the valve yoke and do not touch any moving valve parts.
- ➔ Before exchanging the lever or changing the pin position, disconnect the supply air and electrical auxiliary power.









7.4 Determining the fail-safe position

Define the fail-safe position of the valve (0 % travel) taking the valve type and the actuator's direction of action into account.

- AIR TO OPEN (A_{TO}):
Signal pressure opens the valve, e.g. for a fail-close valve.
- AIR TO CLOSE (A_{TC}):
Signal pressure closes the valve, e.g. for a fail-open valve.

i Note

The AIR TO OPEN (A_{TO}) setting always applies to double-acting actuators.

1. Turn  until Code **0** appears.
2. Press . **MAN** appears and Code 0 blinks.
3. Turn  until **Init** appears. Press .
4. Turn  until the required fail-safe position appears.
5. Press  to confirm.
6. Turn  until **ESC** appears.
7. Press  to exit the entry **or** to start initialization as described in section 7.5.

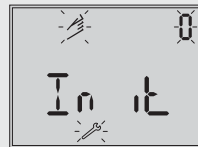

Initialization



AIR TO OPEN



AIR TO CLOSE

For checking purposes: after initialization is completed, the positioner display must read 0 % when the valve is closed and 100 % when the valve is open. If this is not the case, adapt the closing direction and re-initialize the positioner.

7.5 Initializing the positioner

⚠ WARNING

Risk of injury by exposed moving parts on the positioner, actuator or valve.

→ Do not touch or block exposed moving parts.

ⓘ NOTICE

The process is disturbed by the movement of the actuator or valve.

→ Do not perform the initialization while the process is running. First isolate the plant by closing the shut-off valves.

→ Check the max. permissible signal pressure of the valve before starting initialization. During initialization, the positioner issues an output signal pressure up to the maximum supply pressure supplied. If necessary, limit the signal pressure by connecting an up-stream pressure reducing valve.

i Note

Reset positioner to its default settings (see section 7.7) before mounting it on a different actuator or changing its mounting position.

During initialization, the positioner adapts itself optimally to the friction conditions and the signal pressure required by the control valve. The type and extent of auto tuning depends on the initialization mode selected:

- **Maximum range (MAX)** (standard range)
Initialization mode for simple start-up of valves with two clearly defined mechanical end positions, e.g. three-way valves (see section 7.5.1)
- **Nominal range (NOM)**
Initialization mode for all globe valves (see section 7.5.2)
- **Manually selected range (MAN)**
Initialization mode for globe valves with an unknown nominal range (see section 7.5.3)

Operating the positioner

– Substitute calibration (SUB)

This mode allows a positioner to be replaced while the plant is running, with the least amount of disruption to the plant (see section 7.5.4).

i Note

An initialization procedure in progress can be canceled by pressing the rotary pushbutton. **STOP** is displayed for three seconds and the positioner changes to the fail-safe position (**SAFE**). Clear the fail-safe position again over Code 0 (see section 8.2.2).

The time required for the initialization procedure depends on the actuator transit time, which means that initialization can take a few minutes.

After a successful initialization, the positioner runs in closed-loop operation indicated by the  closed-loop operation icon.

A malfunction leads to the process being canceled. The initialization error is displayed according to how it has been classified by the condensed state. Refer to section 8.3.



Alternating readings:
initialization running



Initialization progress
indicated
(MAX, NOM, MAN or
SUB appears, depend-
ing on the initialization
mode selected)



Initialization successfully
completed. Positioner in
automatic mode ()

i Note





When Code **48 - h0 = YES**, the diagnostics automatically start to plot the reference graphs (drive signal steady-state **d1** and hysteresis **d2**) after initialization has been completed. This is indicated by **tes1** and **d1** or **d2** appearing on the display in alternating sequence. An error during the plotting of the reference graphs is indicated on the display over Code **48 - h1** and Code **81**. The reference graphs do not have any effect on closed-loop operation.

7.5.1 Initialization based on maximum range (MAX)

The positioner determines travel/angle of rotation of the closing member from the CLOSED position to the opposite travel stop and adopts this travel/angle of rotation as the operating range from 0 to 100 %.

Enable configuration:





Configuration is locked again if no settings are entered within 120 seconds.

1. Turn  until Code **3** appears (reading: **No**).
2. Press , the code number **3** blinks.
3. Turn  until **YES** appears.
4. Press  to confirm (reading: ).



Enable configuration
Default: No

Select the initialization mode:





1. Turn  until Code **6** appears.
2. Press , the code number **6** blinks.
3. Turn  until **MAX** appears.
4. Press  to confirm the **MAX** initialization mode.



Initialization mode
Default: MAX

Operating the positioner

Start initialization:

1. Turn  until Code **0** appears.
2. Press , the code number **0** blinks.
3. Turn  until Init appears. Press . The fail-safe position setting **AtO** or **AtC** is displayed.
4. Keep  pressed down for six seconds. Initialization starts after the progress indication has stopped.



Initialization



Fail-safe position reading







Progress until initialization starts

The rated travel/angle of rotation is indicated in % after initialization. Code **5** (nominal range) remains locked. The parameters for travel/angle range start (Code **8**) and travel/angle range end (Code **9**) can also only be displayed and modified in %.

For a reading in mm/°, enter the pin position (Code 4).

Enter the pin position:

1. Turn  until Code **4** appears.
2. Press , the code number **4** blinks.
3. Turn  to select pin position on lever (see relevant section on attachment).
4. Press  to confirm. The nominal range is displayed in mm/°.



Pin position
Default: No

7.5.2 Initialization based on nominal range (NOM)





The calibrated sensor allows the effective valve travel to be set very accurately. During initialization, the positioner checks whether the control valve can move through the indicated nominal range (travel or angle) without collision. If this is the case, the indicated nominal range is adopted with the limits of travel/angle range start (Code 8) and travel/angle range end (Code 9) as the operating range.

i Note

The maximum possible travel must always be greater than the rated travel entered. If this is not the case, initialization is automatically canceled (error message Code 52) because the rated travel could not be achieved.

Enable configuration:









Configuration is locked again if no settings are entered within 120 seconds.

1. Turn  until Code **3** appears (reading: **No**).
2. Press , the code number **3** blinks.
3. Turn  until **YES** appears.
4. Press  to confirm (reading: ).



Enable configuration
Default: No

Enter the pin position and nominal range:

1. Turn  until Code **4** appears.
2. Press , the code number **4** blinks.
3. Turn  to select pin position on lever (see relevant section on attachment).
4. Press  to confirm. The nominal range is displayed in mm/°.
5. Turn  until Code **5** appears.
6. Press , the code number **5** blinks.
7. Turn  to select the nominal range of the valve.
8. Press  to confirm.







Pin position
Default: No



Nominal range
(locked when Code 4 = 'No')

Operating the positioner





Select the initialization mode:

1. Turn  until Code **6** appears.
2. Press , the code number **6** blinks.
3. Turn  until **NOM** appears.
4. Press  to confirm the **NOM** initialization mode.



Initialization mode
Default: MAX

Start initialization:

1. Turn  until Code **0** appears.
2. Press , the code number **0** blinks.
3. Turn  until **Init** appears. Press . The fail-safe position setting **AtO** or **AtC** is displayed.
4. Keep  pressed down for six seconds. Initialization starts after the progress indication has stopped.

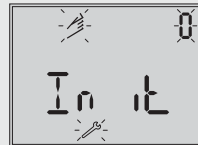

Initialization



Fail-safe position
reading



Progress until
initialization starts









Note

After initialization, check the direction of action (Code 7) and, if necessary, change it.

7.5.3 Initialization based on a manually selected range (MAN)

Before starting initialization, move the control valve manually to the OPEN position. Turn the rotary pushbutton clockwise in small steps. The valve must be moved with a monotonically increasing signal pressure. The positioner calculates the differential travel/angle from the OPEN and CLOSED positions and adopts it as the operating range with limits of travel/angle range start (Code 8) and travel/angle range end (Code 9).

Enter OPEN position:





1. Turn  until Code **0** appears.
2. Press , the code number **0** blinks.
3. Turn  until **MAN** appears.
4. Press  to confirm.
5. Turn  until Code **1** appears.
6. Press , the code number **1** blinks.
7. Turn  until the valve reaches its OPEN position.
8. Press  to confirm.



Manual set point (current angle of rotation is indicated)

Enable configuration:





Configuration is locked again if no settings are entered within 120 seconds.

1. Turn  until Code **3** appears (reading: **No**).
2. Press , the code number **3** blinks.
3. Turn  until **YES** appears.
4. Press  to confirm (reading: ).



Enable configuration
Default: No

Enter the pin position:





1. Turn  until Code **4** appears.
2. Press , the code number **4** blinks.
3. Turn  to select pin position on lever (see relevant section on attachment).
4. Press  to confirm.



Pin position
Default: No

Operating the positioner





Select the initialization mode:

1. Turn  until Code **6** appears.
2. Press , the code number **6** blinks.
3. Turn  until **MAN** appears.
4. Press  to confirm the **MAN** initialization mode.



Initialization mode
Default: MAX

Start initialization:

1. Turn  until Code **0** appears.
2. Press , the code number **0** blinks.
3. Turn  until Init appears. Press . The fail-safe position setting **AtO** or **AtC** is displayed.
4. Keep  pressed down for six seconds. Initialization starts after the progress indication has stopped.

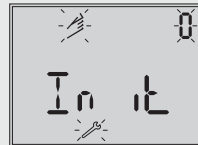

Initialization



Fail-safe position reading



Progress until
initialization starts

7.5.4 Substitute calibration (SUB)

A complete initialization procedure takes several minutes and requires the valve to move through its entire travel range several times. In the SUB initialization mode, the control parameters are estimated and not determined by an initialization procedure. As a result, a high level of accuracy cannot be expected. A different initialization mode should be selected if the plant allows it.

The substitute calibration is used to replace a positioner while the process is running. For this purpose, the control valve is usually fixed mechanically in a certain position or pneumatically





by means of a pressure signal which is routed to the actuator externally. The blocking position ensures that the plant continues to operate with this valve position.

By entering the blocking position (Code **35**), closing direction (Code **34**), pin position (Code **4**), nominal range (Code **5**) and direction of action (Code **7**), the positioner can calculate the positioner configuration.

→ Perform a reset before re-initializing the positioner if the substitute positioner has already been initialized (see section 7.7).

Enable configuration:





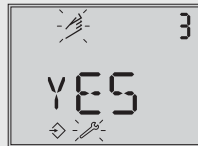



Configuration is locked again if no settings are entered within 120 seconds.

1. Turn  until Code **3** appears (reading: **No**).
2. Press , the code number **3** blinks.
3. Turn  until **YES** appears.
4. Press , to confirm (reading: ).



Enable configuration
Default: No

Enter the pin position and nominal range:

1. Turn  until Code **4** appears.
2. Press , the code number **4** blinks.
3. Turn  to select pin position on lever (see relevant section on attachment).
4. Press , to confirm.
5. Turn  until Code **5** appears.
6. Press , the code number **5** blinks.
7. Turn  to select the nominal range of the valve.
8. Press , to confirm.







Pin position
Default: No



Nominal range
(locked when Code 4 = 'No')

Operating the positioner







Select the initialization mode:

1. Turn  until Code **6** appears.
2. Press , the code number **6** blinks.
3. Turn  until **SUB** appears.
4. Press  to confirm the **SUB** initialization mode.



Initialization mode
Default: MAX



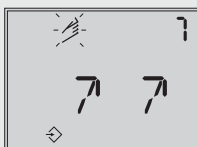

Enter the direction of action:

1. Turn  until Code **7** appears.
2. Press , the code number **7** blinks.
3. Turn  until the direction of action (/) appears.
4. Press  to confirm.



Direction of action
Default: 

Deactivate travel limit:



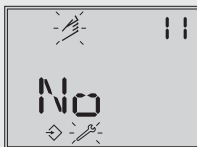

1. Turn  until Code **11** appears.
2. Press , the code number **11** blinks.
3. Turn  until **No** appears.
4. Press  to confirm.



Travel stop
Default: 100.0

Change pressure limit and control parameters:

Do not change the pressure limit (Code **16**). Only change the control parameters K_p (Code **17**) and T_v (Code **18**) if the settings of the replaced positioner are known.

1. Turn  until Code **16/17/18** appears.
2. Press , Code **16/17/18** blinks.
3. Turn  to set the control parameter selected.
4. Press  to confirm.

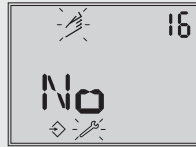

Pressure limit
Default: No

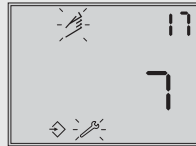









K_p level
Default: 7



T_v level
Default: 2

Enter closing direction and blocking position:

1. Turn  until Code **34** appears.
2. Press , the code number **34** blinks.
3. Turn  to select the closing direction (**CCL** = counterclockwise/**CL** = clockwise)
4. Press  to confirm.
5. Turn  until Code **35** appears.
6. Press , the code number **35** blinks.
7. Turn  to set the blocking position, e.g. 5 mm (read off at travel indicator scale of the blocked valve or measure with a ruler).
8. Press  to confirm.





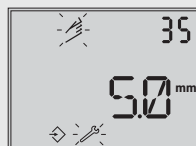

Closing direction (direction of rotation causing the valve to move to the CLOSED position (view onto positioner display)
Default: CCL (counterclockwise)



Blocking position
Default: 0

Operating the positioner

Start initialization:

1. Turn  until Code **0** appears.
2. Press , the code number **0** blinks.
3. Turn  until **Init** appears. Press . The fail-safe position setting **AtO** or **AtC** is displayed.



Initialization



Fail-safe position reading

4. Keep  pressed down for six seconds. Initialization starts after the progress indication has stopped. The positioner switches to **MAN** mode. The blocking position is indicated.



Progress until initialization starts

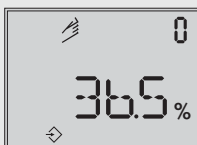









Blocking position

Since initialization has not been completed, the error code 76 (no emergency mode) and possibly also error code 57 (control loop) may appear on the display.

These alarms do not influence the positioner's readiness for operation.

Cancel the blocking position and change to automatic mode (AUTO):

For the positioner to follow its set point again, the blocking position must be canceled and the positioner must be set to automatic mode as follows:

1. Turn  until Code **1** appears.
2. Press , the code number **1** and  icon blink.
3. Turn  to build up pressure in the positioner to move the valve slightly past the blocking position.
4. Press  to cancel the mechanical blocking.
5. Turn  until Code **0** appears.
6. Press , the code number **0** blinks.
7. Turn  until **AUTO** appears.
8. Press . The positioner switches to automatic mode. The current valve position is indicated in %.

- If the positioner shows a tendency to oscillate in automatic mode, the parameters K_p and T_v must be slightly corrected. To do this, proceed as follows:
- Set T_v (Code 18) to 4.
 - If the positioner still oscillates, the gain K_p (Code 17) must be decreased until the positioner shows a stable behavior.

Zero point calibration

Finally, if process operations allow it, the zero point must be calibrated according to section 7.6.

7.6 Zero calibration

In case of inconsistencies in the closing position of the valve, e.g. with soft-seated plugs, it might be necessary to recalibrate zero.

⚠ WARNING

Risk of injury by exposed moving parts on the positioner, actuator or valve.

→ *Do not touch or block exposed moving parts.*

ⓘ NOTICE





The process is disturbed by the movement of the actuator or valve.

→ *Do not perform the zero calibration while the process is running. First isolate the plant by closing the shut-off valves.*









i Note

The positioner must be connected to the supply air to perform the zero calibration.

Enable configuration:

1. Turn  until Code **3** appears (reading: **No**).
2. Press , the code number **3** blinks.
3. Turn  until **YES** appears.
4. Press  to confirm (reading: ).

Perform zero calibration:

1. Turn  until Code **6** appears.
2. Press , the code number **6** blinks.
3. Turn  until **ZP** appears.
4. Press  to confirm.
5. Turn  until Code **0** appears.
6. Press , reading: **MAN**, Code **0** blinks.
7. Turn  until **Init** appears. Press . The fail-safe position setting **AtO** or **AtC** is displayed.
8. Press  and hold for six seconds.
Zero calibration starts. The positioner moves the valve to the CLOSED position and recalibrates the internal electrical zero point.

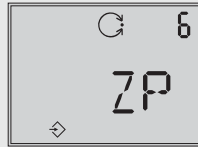





Initialization mode
Default: MAX

7.7 Reset to default settings





This function resets all start-up parameters as well as the diagnosis to the factory default settings (see code list in section 1.2.2).

Enable configuration:

1. Turn  until Code **3** appears (reading: **No**).
2. Press , the code number **3** blinks.
3. Turn  until **YES** appears.
4. Press  to confirm (reading: ).

Operating the positioner

Reset start-up parameters:

1. Turn  until Code **36** appears (reading: ●●-●●-).
2. Press , the code number **36** blinks.
3. Turn  until **Std** appears.
4. Press  to confirm.

All start-up parameters as well as the diagnosis are reset to their default values.

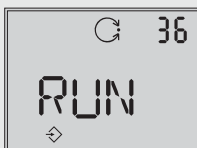

Reset
Default: No

i Note

Code **36** - **diAG** allows just the diagnosis data (*EXPERTplus*) to be reset (► EB 8389).

8 Operation

⚠ WARNING





Risk of injury by exposed moving parts on the positioner, actuator or valve.

→ *Do not touch or block exposed moving parts during operation.*





8.1 Enabling and selecting parameters

All codes and their meaning and default settings are listed in the code list in section 12.2 on page 88 onwards.

Codes which are marked with an asterisk must be enabled with Code 3 before the associated parameters can be configured as described below.

1. Turn  until Code 3 appears (reading: **No**).
2. Press , the code number 3 blinks.
3. Turn  until **YES** appears.
4. Press  to confirm (reading: ).

You can now configure codes one after the other:

- Turn  to select the required code.
- Press  to activate the selected code. The code blinks.
- Turn  to select the setting.
- Press  to confirm the selected setting.

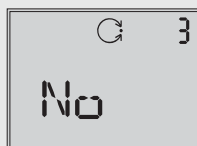

Code 3:
Configuration not
enabled

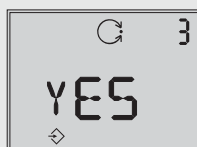

Configuration enabled



i Note

If no settings are entered within 120 seconds, the enabled configuration function becomes invalid and the display returns to Code 0.

Operation

Cancel the setting:

To cancel a value before it is confirmed (by pressing ) proceed as follows:

1. Turn  until **ESC** appears.
2. Press  to confirm.

The entered value is not adopted.

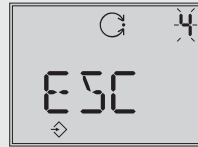

Canceling the reading

8.2 Operating modes



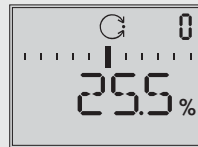

8.2.1 Automatic (AUTO) and manual (MAN) modes

After initialization has been completed successfully, the positioner is in automatic mode (**AUTO**, reading: )



Automatic mode

Switching to manual mode (MAN)

1. Turn  until Code **0** appears.
2. Press , Code **0** blinks, display: **AUTO**.
3. Turn  until **MAN** appears.
4. Press . The positioner changes to the manual mode.

The manual mode starts using the last set point used in automatic mode, ensuring a bumpless changeover. The current position is displayed in %.





Automatic mode



Manual mode

Adjust the manual set point



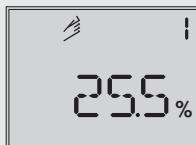

1. Turn  until Code **1** appears.
2. Press , the code number **1** blinks.
3. Turn  until sufficient pressure has been built up in the positioner and the control valve moves to the required position.



i Note





The positioner automatically returns to Code 0 if no settings are made within 120 seconds, but remains in the manual mode.

Switch to automatic mode

1. Turn  until Code **0** appears.
2. Press , the code number **0** blinks.
3. Turn  until **AUTO** appears.
4. Press . The positioner switches to automatic mode.

8.2.2 Fail-safe position (SAFE)



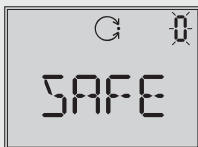

If you want to move the valve to the fail-safe position determined during start-up (see section 7.4), proceed as follows:

1. Turn  until Code **0** appears.
2. Press , Code **0** blinks, display: current operating mode (**AUTO** or **MAN**).
3. Turn  until **SAFE** appears.
4. Press  to confirm. The reading **S** appears.



The valve moves to the fail-safe position. If the positioner has been initialized, the current valve position in % is indicated on the display.

Exit the fail-safe position

1. Turn  until Code **0** appears.
2. Press , the code number **0** blinks.
3. Turn  and select the required operating mode (**AUTO** or **MAN**).
4. Press  to confirm.

The positioner switches to the operating mode selected.

8.3 Fault/malfunction

A status classification is assigned to all status and fault alarms in the positioner. The default settings of the status classification are listed in the code list.

Note

The assignment of the status classification can be changed in TROVIS-VIEW and over the parameters of the DD (► EB 8389).



To provide a better overview, the classified messages are summarized in a condensed state for the positioner. The status messages are divided into the following categories:

- **Maintenance alarm**
The positioner cannot perform its control task due to a malfunction in the positioner itself or in one of its peripherals or the positioner has not yet been successfully initialized.
- **Maintenance required**
The positioner still performs its control task (with restrictions). A maintenance demand or above average wear has been determined. The wear tolerance will soon be exhausted or is reducing at a faster rate than expected. Maintenance is necessary in the medium term.
- **Maintenance demanded**
The positioner still performs its control task (with restrictions). A maintenance demand or above average wear has been determined. The wear tolerance will soon be exhausted or is reducing at a faster rate than expected. Maintenance is necessary in the short term.
- **Out of specification**
The device is running outside the specified operating conditions..

i Note

If an event is classified as “No message”, this event does not have any affect on the condensed state.

The condensed state is displayed on the positioner represented by the following icons:

Condensed state	Positioner display
Maintenance alarm	
Function check	Text e.g. <i>tESing</i> , <i>tunE</i> or <i>tESi</i>
Maintenance required/maintenance demanded	
Out of specification	 blinking

If the positioner has not been initialized, the maintenance alarm icon () is displayed as the positioner cannot follow its set point.

If fault alarms exist, the possible source of error is displayed in Code 49 onwards. In this case, Err is displayed.

Operation

Example:

- Refer to the code list (see section 1.2.2) for possible causes and the recommended action.

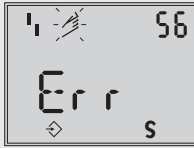

Example:
Pin position error

Fault alarm output

'Maintenance alarm' as the condensed state causes the optional fault alarm output to be switched.

- The 'Function check' condensed state can also activate the fault alarm output (Code 32).
- The 'Maintenance required/Maintenance demanded' condensed state can also activate the fault alarm output (Code **33**).

8.3.1 Confirming error messages

Enable configuration:

1. Turn until Code **3** appears (reading: **No**).
2. Press , the code number **3** blinks.
3. Turn until **YES** appears.
4. Press to confirm (reading:).

Confirming error message:

1. Turn until the the error code that you want appears.
2. Press to confirm the error message.

9 Servicing

i Note

The positioner was checked by SAMSON before it left the factory.

- The product warranty becomes void if service or repair work not described in these instructions is performed without prior agreement by SAMSON's After-sales Service.*
 - Only use original spare parts by SAMSON, which comply with the original specifications.*
-

The positioner does not require any maintenance. There are filters with a 100 µm mesh size in the pneumatic connections for supply and output which can be removed and cleaned, if required. The maintenance instructions of any upstream supply air pressure reducing stations must be observed.

9.1 Preparation for return shipment



Defective positioners can be returned to SAMSON for repair.

Proceed as follows to return devices to SAMSON:

1. Put the control valve out of operation.
See associated valve documentation.
2. Remove the positioner (see section 11.2).
3. Send the positioner to your nearest SAMSON subsidiary. SAMSON subsidiaries are listed on our website at
▶ www.samsongroup.com > Contact.

10 Malfunctions

Malfunctions are indicated on the display by error codes. Section 12.3 lists possible error messages and recommended action.

The error codes appear on the display corresponding to their status classification set over the condensed state (Maintenance required/ Maintenance demanded: , Out of specification:  blinking, Maintenance alarm: ). If 'No message' is assigned to the error code as the status classification, the error is not included in the condensed state.

A status classification is assigned to every error code in the default setting. The status classification of error codes can also be changed as required using an operator software (e.g. TROVIS-VIEW).

10.1 Emergency action

Upon failure of the air supply, the positioner vents the actuator, causing the valve to move to the fail-safe position determined by the actuator.

Plant operators are responsible for emergency action to be taken in the plant.



Tip

Emergency action in the event of valve or actuator failure is described in the associated valve and actuator documentation.

11 Decommissioning and removal

DANGER

Risk of fatal injury due to ineffective explosion protection.

The explosion protection becomes ineffective when the positioner cover is opened.

→ *The following regulations apply to installation in hazardous areas: EN 60079-14 (VDE 0165, Part 1).*

NOTICE

The process is disturbed by interrupting closed-loop control.

→ *Do not mount or service the positioner while the process is running and only after isolating the plant by closing the shut-off valves.*

11.1 Decommissioning

To decommission the positioner before removing it, proceed as follows:

1. Disconnect and lock the air supply and signal pressure.
2. Open the positioner cover and disconnect the wires for the control signal.

11.2 Removing the positioner

1. Disconnect the wires for the control signal from the positioner.

2. Disconnect the lines for supply air and signal pressure (not required for direct attachment using a connection block).
3. To remove the positioner, loosen the three fastening screws on the positioner.

11.3 Disposal



We are registered with the German national register for waste electric equipment (stiftung ear) as a producer of electrical and electronic equipment, WEEE reg. no.: DE 62194439

- Observe local, national and international refuse regulations.
- Do not dispose of components, lubricants and hazardous substances together with your other household waste.

i Note

We can provide you with a recycling passport according to PAS 1049 on request. Simply e-mail us at aftersalesservice@samsongroup.com giving details of your company address.

💡 Tip

On request, we can appoint a service provider to dismantle and recycle the product.

12 Annex

12.1 After-sales service

Contact SAMSON's After-sales Service for support concerning service or repair work or when malfunctions or defects arise.

E-mail address

You can reach our after-sales service at aftersalesservice@samsongroup.com.

Addresses of SAMSON AG and its subsidiaries

The addresses of SAMSON AG, its sales sites worldwide can be found on our website (www.samsongroup.com) or in all SAMSON product catalogs.

Required specifications

Please submit the following details:

- Order number and position number in the order
- Type, serial number, firmware version, device version

12.2 Code list

Code no.	Parameter – Readings/values [default setting]	Description
Note: Codes marked with an asterisk (*) must be enabled with Code 3 prior to configuration.		
0	Operating mode [MAN], AUTO, SAFE, ESC Init AtO/AtC	MAN Manual mode AUTO Automatic mode SAFE Fail-safe position ESC Cancel In MAN and AUTO mode, the system deviation is represented by the bar graph elements. The reading indicates the valve position or angle of rotation in % when the positioner is initialized. If the positioner is not initialized, the position of the lever in relation to the mid-axis is displayed in degrees (°). Switchover from automatic to manual mode is bumpless. In fail-safe position, the S icon is displayed. Init Start initialization Determine the fail-safe position: AtO: AIR TO OPEN (the signal pressure opens the valve, e.g. for a fail-close valve) AtC: AIR TO CLOSE (the signal pressure closes the valve, e.g. for a fail-open valve)
1	Manual set point w [0] to 100 % of the nominal range	Set the manual set point The current travel/angle is displayed in % when the positioner is initialized. If the positioner is not initialized, the position of the lever in relation to the mid-axis is indicated in degrees (°). Note: can only be selected when Code 0 = MAN
2	Reading direction [Normal] or upside down ESC	The reading direction of the display is turned by 180°.
3	Enable configuration [No], YES, ESC	Enables changing of data (automatically deactivated when the rotary pushbutton has not been operated for 120 seconds). Codes marked with an asterisk (*) can only be read and not overwritten when their configuration is not enabled. HART blinks on the display when the on-site operation is locked over HART® communication. Similarly, codes can only read over the SSP interface.

Code no.	Parameter – Readings/values [default setting]	Description																											
4*	<p>Pin position [No], 17, 25, 35, 50, 70, 100, 200, 300 mm, 90° with rotary actuators, ESC</p> <p><i>If you select a pin position in Code 4 that is too small, the positioner switches to fail-safe position mode (SAFE) for reasons of safety.</i></p>	<p>Follower pin must be mounted in the proper position depending on the valve travel/opening angle. Pin position must be entered for nominal (NOM) or substitute (SUB) initialization.</p> <table border="1" data-bbox="449 379 1061 715"> <thead> <tr> <th data-bbox="449 379 650 440">Pin position Code 4</th> <th data-bbox="650 379 807 440">Standard Code 5</th> <th data-bbox="807 379 1061 440">Adjustment range Code 5</th> </tr> </thead> <tbody> <tr> <td data-bbox="449 440 650 472">17</td> <td data-bbox="650 440 807 472">7.5</td> <td data-bbox="807 440 1061 472">3.6 to 18.0</td> </tr> <tr> <td data-bbox="449 472 650 504">25</td> <td data-bbox="650 472 807 504">7.5</td> <td data-bbox="807 472 1061 504">5.0 to 25.0</td> </tr> <tr> <td data-bbox="449 504 650 536">35</td> <td data-bbox="650 504 807 536">15.0</td> <td data-bbox="807 504 1061 536">7.0 to 35.0</td> </tr> <tr> <td data-bbox="449 536 650 568">50</td> <td data-bbox="650 536 807 568">30.0</td> <td data-bbox="807 536 1061 568">10.0 to 50.0</td> </tr> <tr> <td data-bbox="449 568 650 600">70</td> <td data-bbox="650 568 807 600">40.0</td> <td data-bbox="807 568 1061 600">14.0 to 70.7</td> </tr> <tr> <td data-bbox="449 600 650 632">100</td> <td data-bbox="650 600 807 632">60.0</td> <td data-bbox="807 600 1061 632">20.0 to 100.0</td> </tr> <tr> <td data-bbox="449 632 650 663">200</td> <td data-bbox="650 632 807 663">120.0</td> <td data-bbox="807 632 1061 663">40.0 to 200.0</td> </tr> <tr> <td data-bbox="449 663 650 715">90°</td> <td data-bbox="650 663 807 715">90.0</td> <td data-bbox="807 663 1061 715">24.0 to 100.0</td> </tr> </tbody> </table>	Pin position Code 4	Standard Code 5	Adjustment range Code 5	17	7.5	3.6 to 18.0	25	7.5	5.0 to 25.0	35	15.0	7.0 to 35.0	50	30.0	10.0 to 50.0	70	40.0	14.0 to 70.7	100	60.0	20.0 to 100.0	200	120.0	40.0 to 200.0	90°	90.0	24.0 to 100.0
Pin position Code 4	Standard Code 5	Adjustment range Code 5																											
17	7.5	3.6 to 18.0																											
25	7.5	5.0 to 25.0																											
35	15.0	7.0 to 35.0																											
50	30.0	10.0 to 50.0																											
70	40.0	14.0 to 70.7																											
100	60.0	20.0 to 100.0																											
200	120.0	40.0 to 200.0																											
90°	90.0	24.0 to 100.0																											
5*	<p>Nominal range mm or angle °, ESC</p>	<p>Nominal valve travel or opening angle must be entered for nominal (NOM) or substitute (SUB) initialization. The possible adjustment range depends on the pin position from the table for Code 4. Code 5 is generally locked until Code 4 is set to 'No', i.e. after a pin position has been entered, Code 5 can be configured. Indicates maximum travel/angle reached during initialization after initialization has been successfully completed.</p>																											
6*	<p>Initialization mode [MAX], NOM, MAN, SUB, ZP, ESC</p>	<p>MAX: Maximum range of the control valve, the travel/angle of the closure member from the CLOSED position to the opposite stop in the actuator.</p> <p>NOM: Nominal range of the control valve, the travel/angle of the closure member measured from the CLOSED position to the indicated OPEN position.</p> <p>MAN: Manually selected range</p> <p>SUB: Substitute calibration (without initialization)</p> <p>ZP: Zero calibration</p>																											

Code no.	Parameter – Readings/values [default setting]	Description
7*	Direction of action (w/x) [↗↗], ↗↘, ESC	Direction of action of the set point w in relation to the travel/angle x (increasing/increasing or increasing/decreasing) Automatic adaptation: AIR TO OPEN: On completing initialization, the direction of action remains increasing/increasing (↗↗). A globe valve opens as the mA signal increases. AIR TO CLOSE: On completing initialization, the direction of action changes to increasing/decreasing (↗↘). A globe valve closes as the mA signals increases.
8*	Travel/angle range start (lower x-range value) [0.0] to 80.0 % of the nominal range, ESC <i>Specified in mm or angle ° provided Code 4 is activated.</i>	Lower range value for travel/angle in nominal or operating range The operating range is the actual travel/angle of the control valve and is limited by the travel/angle range start (Code 8) and the travel/angle range end (Code 9). Usually, the operating range and the nominal range are identical. The nominal range can be limited to the operating range by the travel/angle range start and end values. The value is displayed or must be entered. The characteristic is adapted. See also the example in Code 9.
9*	Travel/angle range end (upper x-range value) 20.0 to [100.0 %] of the nominal range, ESC <i>Specified in mm or angle ° provided Code 4 is activated.</i>	Upper range value for travel/angle in nominal or operating range. The value is displayed or must be entered. The characteristic is adapted. Example: The operating range is modified, for example to limit the range of a control valve which has been sized too large. For this function, the entire resolution range of the set point is converted to the new limits. 0 % on the display corresponds to the adjusted lower limit and 100 % to the adjusted upper limit.
10*	Lower travel/angle limit (lower x-limit) 0.0 to 49.9 % of the operating range, [No], ESC	Lower limitation of the travel/angle of rotation to the entered value. The characteristic is not adapted. See also the example in Code 11.

Code no.	Parameter – Readings/values [default setting]	Description
11*	Upper travel/angle limit (upper x-limit) 50.0 to 120.0 %, [100 %] of the operating range, No, ESC	Limits travel/angle to the entered value (upper limit) When set to 'No', the valve can be opened past the rated travel with a set point outside of the 0 to 100 % range. The characteristic is not adapted. Example: In some applications, it is better to limit the valve travel, e.g. if a certain minimum medium flow is required or a maximum flow must not be reached. The lower limit must be adjusted with Code 10 and the upper limit with Code 11. If a tight-closing function has been set up, it has priority over the travel limitation.
12*	Set point range start (w-start) [0.0] to 75.0 % of the set point range, ESC	The lower set point range value must be lower than upper range value (w-end), 0 % = 4 mA. The set point range is the difference between w-end and w-start and must be $\Delta w \geq 25 \% = 4 \text{ mA}$. When the set point range of 0 to 100 % = 4 to 20 mA, the valve must move through its entire operating range from 0 to 100 % travel/angle of rotation. In split-range operation , the valves operate with smaller set points. The control signal of the control unit to control two valves is divided such, for instance, that the valves move through their full travel/angle of rotation at only half the input signal (first valve set to 0 to 50 % = 4 to 12 mA and second valve set to 50 to 100 % = 12 to 20 mA).
13*	Set point, upper range value (w-end) 25.0 to [100.0 %] of the set point range, ESC	Upper range value (100 % = 20 mA) of valid set point range This value must be greater than the lower range value.
14*	Set point cutoff decrease 0.0 to 49.9 %, [1.0 %], No, ESC	If the set point w reaches up to the entered percentage at the final value that causes the valve to close, the actuator is immediately completely vented (with AIR TO OPEN) or filled with air (with AIR TO CLOSE). This action always lead to maximum tight-closing of the valve. Codes 14/15 have priority over Codes 8/9/10/11. Codes 21/22 have priority over Codes 14/15.

Code no.	Parameter – Readings/values [default setting]	Description
15*	Set point cutoff increase 50.0 to 100.0 %, ESC	If the set point w reaches up to the entered percentage at the final value that causes the valve to open, the actuator is immediately filled with air (with AIR TO OPEN) or completely vented (with AIR TO CLOSE). This action always leads to the valve being completely opened. The signal pressure can be limited in Code 16. Codes 14/15 have priority over Codes 8/9/10/11. Codes 21/22 have priority over Codes 14/15. Example: Set the cutoff to 99 % for three-way valves.
16*	Pressure limit [No], P 1.4/2.4/3.7, ESC	The signal pressure to the actuator can be limited in stages. After changing a pressure limit already set, the actuator must be vented once (e.g. by selecting the fail-safe position (SAFE) over Code 0). Note: Do not activate pressure limitation for double-acting actuators (with fail-safe position AIR TO OPEN).
17*	Proportional-action coefficient K_p level 0 to 17 [7], ESC	Changing the K_p and T_v levels: During positioner initialization, the values for K_p and T_v are optimized. If the positioner tends to overshoot impermissibly due to other disturbances, the K_p and T_v levels can be adapted accordingly after initialization. Increment T_v level until desired behavior is reached or when the maximum value of 4 is reached, the K_p level can be decreased in increments. K_p level changes affect the set point deviation.
18*	Derivative-action time T_v level 1, [2], 3, 4, No, ESC	See Code 17 A change of the T_v level has no effect on the system deviation.
19*	Tolerance band 0.1 to 10.0 %, [5.0 %] of the operating range, ESC	Used for error monitoring. Determination of the tolerance band in relation to the operating range. Associated lag time (30 s) is a reset criterion. If a transit time is determined during initialization which is six times longer than 30 s, the six-fold transit time is accepted as the lag time.

Code no.	Parameter – Readings/ values [default setting]	Description
20*	Valve characteristic selection [0] to 9, ESC	Valve characteristic selection 0 Linear 1 Equal percentage 2 Reverse equal percentage 3 SAMSON butterfly valve, linear 4 SAMSON butterfly valve, equal percentage 5 VETEC rotary plug valve, linear 6 VETEC rotary plug valve, equal percentage 7 Segmented ball valve, linear 8 Segmented ball valve, equal percentage 9 User-defined (defined over operator software) Note: Characteristics (see section 12.4)
21*	Transit time OPEN (w ramp OPEN) [0] to 240 s, ESC	Time required to move through the operating range when opening the valve. Limitation of the transit time (Code 21 and 22): For some applications it is recommendable to limit the transit time of the actuator to prevent it from engaging too fast in the running process. Code 21 has priority over Code 15.
22*	Transit time CLOSED (w ramp CLOSED) [0] to 240 s, ESC	Time required to move through the operating range when closing the valve. Code 22 has priority over Code 14.
23*	Total valve travel [0] to 99×10^7 , RES, ESC Exponential reading from 9999 travel cycles onwards	Totaled double valve travel Can be reset to 0 by selecting RES. Note: the total valve travel is saved in a non-volatile memory after every 1000 full valve travel cycle.
24*	Total valve travel limit 1000 to 99×10^7 , [1,000000], ESC Exponential reading from 9999 travel cycles onwards	Total valve travel limit. The fault alarm and wrench icon appear on the positioner display.

Code no.	Parameter – Readings/ values [default setting]	Description												
25	Binary output [A1 -/-], ESC	<p>This code allows you to find out on site whether the positioner has an optional binary output or not. When a binary output exists, its switching behavior can be read and set.</p> <p>If there is no binary output, '- - -' appears on the positioner display.</p> <p>The binary contacts A1, A2 and the fault alarm output can be configured at the output as follows:</p> <table border="0"> <thead> <tr> <th style="text-align: left;">Alternating reading</th> <th style="text-align: left;">Meaning</th> </tr> </thead> <tbody> <tr> <td>A1 -/-</td> <td>A1 functioning as NO contact</td> </tr> <tr> <td>A1 ----</td> <td>A1 functioning as NC contact</td> </tr> <tr> <td>A2 -/-</td> <td>A2 functioning as NO contact</td> </tr> <tr> <td>A2 ----</td> <td>A2 functioning as NC contact</td> </tr> <tr> <td>FAUL FAUL</td> <td>Fault alarm output (always NC contact)</td> </tr> </tbody> </table>	Alternating reading	Meaning	A1 -/-	A1 functioning as NO contact	A1 ----	A1 functioning as NC contact	A2 -/-	A2 functioning as NO contact	A2 ----	A2 functioning as NC contact	FAUL FAUL	Fault alarm output (always NC contact)
Alternating reading	Meaning													
A1 -/-	A1 functioning as NO contact													
A1 ----	A1 functioning as NC contact													
A2 -/-	A2 functioning as NO contact													
A2 ----	A2 functioning as NC contact													
FAUL FAUL	Fault alarm output (always NC contact)													
26*	Limit A1 0.0 to 100.0 % of the operating range, [2.0 %], No, ESC	Software limit value A1 is displayed or can be changed in relation to the operating range.												
27*	Limit A2 0.0 to 100.0 % of the operating range, [98.0 %], No, ESC	Software limit value A2 is displayed or can be changed in relation to the operating range.												
28*	Alarm test Reading direction: Standard Turned [No] [No] RUN 1 1 RUN RUN 2 2 RUN RUN 3 3 RUN ESC ESC	<p>Testing the software limit switch alarm A1 and A2 as well as the fault alarm contact A3.</p> <p>If the test is activated, the contact is switched five times.</p> <p>RUN 1/1 RUN: software limit contact A1 RUN 2/2 RUN: software limit contact A2 RUN 3/3 RUN: fault alarm contact A3</p>												

Code no.	Parameter – Readings/values [default setting]	Description
29*	Position transmitter x/ix ³⁾ [↶, ↷, ESC	Operating direction of the optional position transmitter: it indicates how the travel/angle position is assigned to the output signal i, based on the fail-safe position. The operating range (see Code 8) of the valve is represented by the 4 to 20 mA signal. The signal is 0.9 mA when a positioner has not been connected (set point less than 3.6 mA) and 3.8 mA when the positioner has not been initialized.
30*	Fault alarm ix ³⁾ [No], HI, LO, ESC	Select if and how faults that cause the fault alarm contact to be switched are also indicated at the position transmitter output. HI ix =21.6 mA or LO ix =2.4 mA
31*	Position transmitter test ³⁾ -10.0 to 110.0 % of the operating range, [default value is last indicated value of the position transmitter], ESC	Testing the position transmitter. Values can be entered in relation to the operating range. The momentary valve position is used in initialized positioners locally as the start value (bumpless changeover to the test mode). When testing by software, the entered simulation value is issued as the position feedback signal for 30 seconds.
³⁾ Analog position transmitter: Code 29/30/31 can only be selected if the position transmitter (optional) is installed.		
32*	Function check alarm No, [YES], ESC	The condensed state can be indicated as a fault alarm output over the optional binary contact and the optional position transmitter (see Code 25). YES: The 'Function check' condensed state activates the fault alarm output. No: The 'Function check' condensed state has no effect on the fault alarm output.
33*	Maintenance required alarm No, [YES], ESC	YES: Both the 'Maintenance alarm' condensed state and 'Maintenance required'/'Maintenance demanded' condensed state activate the fault alarm output. No: Only the 'Maintenance alarm' condensed state activates the fault alarm output, whereas 'Maintenance required'/'Maintenance demanded' condensed state does not. Regardless of the condensed state, the fault alarm output always switches when the error codes 57, 58, 60, 62 and 64 to 70, 76 are issued.

Code no.	Parameter – Readings/ values [default setting]	Description
34*	Closing direction CL, [CCL], ESC	CL: Clockwise CCL: Counterclockwise Lever's turning direction for travel pick-off which causes the CLOSED position of the control valve to be reached (view onto the positioner display). Only necessary with SUB initialization mode.
35*	Blocking position [0.0] mm/°/%, ESC	Distance to CLOSED position (0 % position). Only necessary with SUB initialization mode.
36*	Reset [No], Std, diAG, ESC	Std: Resets all parameters to their default settings and clears the diagnosis data. After a reset, the positioner must be re-initialized. diAG: Resets diagnosis data only. Plotted reference graphs and logs remain saved. The positioner does not need to be re-initialized.
37*	Position transmitter [No], YES, ESC	Read only. Indicates whether an optional position transmitter is installed.
38*	Inductive alarm No	Option not available
39	Set point deviation e info Read only	Difference of the target position ($e = w - x$)
40	Min. transit time OPEN Read only	Time [s] required by the system (positioner, actuator and valve) to move through the rated travel/angle in the direction to open the valve (100 % position).
41	Min. transit time CLOSED Read only	Time [s] required by the system (positioner, actuator and valve) to move through the rated travel/angle in the direction to close the valve (0 % position).
42	Auto-w/manual-w 0.0 to 100.0 % of the span 4 to 20 mA	Set point w used in automatic mode 4 to 20 mA correspond to 0 to 100 %
43	Firmware version for control Read only	Device type and current firmware version (displayed in alternating sequence)

Code no.	Parameter – Readings/ values [default setting]	Description
44	y info Read only	Control signal y [%] in relation to the travel range determined during initialization MAX: The positioner builds up its maximum output pressure, see description in Code 14 and 15. OP: The positioner vents completely, see description in Code 14 and 15. -- --: The positioner is not initialized.
45	Forced venting status Read only	Indicates whether the option is installed or not. No No forced venting installed YES Forced venting installed If a voltage supply is connected at the terminals of the forced venting option, YES and HIGH appear on the display in alternating sequence. If a voltage supply is not connected (actuator vented, fail-safe position indicated on the display by the S icon), YES and LOW appear on the display in alternating sequence.
46*	Polling address [0] to 15/63, ESC	Select bus address 0 to 15 for active HART® Revision 5 (default setting) 0 to 63 for active HART® Revision 6 Switchover is only possible through the operating software.
47*	HART® write protection status [No], YES, ESC	When write protection is active, device data can be read, but not overwritten over HART® communication.
48* 49*	Diagnostic parameters	Details on EXPERTplus Valve Diagnostics in the Operating Instructions ▶ EB 8389.

12.3 Error codes

Initialization error

Error codes – Recommended action		Condensed state message active, when prompted, <i>Err</i> appears. When fault alarms exist, they are displayed here.
50	x > range	Value of measuring signal too high or too low; the lever operates near its mechanical stops. <ul style="list-style-type: none"> • Pin not mounted properly • NAMUR attachment: bracket slipped or follower pin not properly seated on the follower plate's slot. • Follower plate not mounted properly.
	Status classification	[Maintenance required]
	Recommended action	<ul style="list-style-type: none"> • Check attachment and pin position. • Set operating mode from SAFE to MAN. • Re-initialize the positioner.
51	$\Delta x < \text{range}$	Insufficient measuring span of the sensor <ul style="list-style-type: none"> • Pin not mounted properly. • Wrong lever mounted. <p>An angle of rotation smaller than 16° at the positioner shaft only generates an alarm. An angle below 9° leads to the initialization being canceled.</p>
	Status classification	[Maintenance required]
	Recommended action	<ul style="list-style-type: none"> • Check attachment. • Re-initialize positioner.
52	Attachment	<ul style="list-style-type: none"> • Invalid positioner attachment • Rated travel/angle (Code 5) could not be achieved during NOM initialization (no tolerance downwards permissible). • Mechanical or pneumatic fault, e.g. wrong lever selected or supply pressure too low to move to the required position.
	Status classification	[Maintenance required]
	Recommended action	Check attachment and supply pressure. Re-initialize the positioner. Under certain circumstances, it may be possible to check the maximum travel/angle by entering the actual pin position and then performing a MAX initialization. After initialization has been completed, the Code 5 indicates the maximum achieved travel or angle.

Error codes – Recommended action		Condensed state message active, when prompted, Err appears. When fault alarms exist, they are displayed here.
53	Initialization time exceeded (initialization time >)	Initialization cycle takes too long. <ul style="list-style-type: none"> • No pressure in supply line or pneumatic leakage • Supply air failure during initialization
	Status classification	[Maintenance required]
	Recommended action	Check attachment and air supply line. Re-initialize the positioner.
54	Initialization – Forced venting	<ol style="list-style-type: none"> 1. A forced venting function is installed (Code 45 = 'YES') and has not been connected or not properly. As a result, actuator pressure cannot build up. The alarm is generated when you attempt to initialize the positioner. 2. If you attempt to initialize the positioner from the fail-safe position (SAFE).
	Status classification	[Maintenance required]
	Recommended action	<ol style="list-style-type: none"> 1. Check connection and supply voltage of forced venting. Code 45 HIGH/LOW 2. Set the MAN mode in Code 0. Re-initialize the positioner.
55	Transit time not reached (transit time <)	Actuator transit times detected during initialization are so short that optimal positioner tuning is impossible.
	Status classification	[Maintenance required]
	Recommended action	Install a signal pressure restriction as described in section 5.
56	Pin position	Initialization canceled because selected NOM and SUB initialization modes require the pin position to be entered.
	Status classification	[Maintenance required]
	Recommended action	Enter pin position over Code 4 and rated travel/angle over Code 5. Re-initialize the positioner.

Operational errors

Error codes – Recommended action		Condensed state message active, when prompted, Err appears. When fault alarms exist, they are displayed here.
57	Control loop Additional alarm at the fault alarm contact	Control loop error, the valve no longer follows the controlled variable within tolerable times (tolerance band alarm Code 19). <ul style="list-style-type: none"> • Actuator is blocked. • Positioner attachment has shifted subsequently. • Insufficient supply pressure
	Status classification	[Maintenance required]
	Recommended action	<ul style="list-style-type: none"> • Check attachment.
58	Zero point	Incorrect zero position. Error can occur when the positioner's attachment position is shifted or when the valve trim is worn, particularly with soft-sealed plugs.
	Status classification	[Maintenance required]
	Recommended action	<p>Check valve and attachment of the positioner. If OK, perform a zero calibration over Code 6 (see section 7.6).</p> <p>If the lever position on the back of the positioner has been changed (e.g. while exchanging the lever), move the lever as far as it will go in both directions to adapt it to the internal measuring lever.</p> <p>We recommend to re-initialize the positioner if zero deviates by more than 5 %.</p>
59	Auto-correction	Errors in the positioner's data section are detected detected by automatic monitoring and corrected automatically.
	Status classification	Automatic
60	Fatal error Additional alarm at the fault alarm contact	Error in safety-relevant data that cannot be corrected automatically. Possible cause: EMC disturbances. The positioner goes to the fail-safe position (SAFE).
	Status classification	Maintenance alarm (cannot be classified)
	Recommended action	Reset over Code 36 . Re-initialize positioner (see sections 7.7 and 7.5).

Hardware errors

Error codes – Recommended action		Condensed state message active, when prompted, Err appears. When fault alarms exist, they are displayed here.
62	x signal Additional alarm at the fault alarm contact	<ul style="list-style-type: none"> • Actuator's measured value recording failed. • Conductive plastic element defective. <p>The device continues functioning in emergency mode but it must be replaced as quickly as possible.</p> <p>The emergency mode on the display is indicated by a blinking closed-loop operation icon and four dashes instead of the position reading.</p> <p>Note on the open-loop operation: If the measuring system has failed, the positioner is still in a reliable state. The positioner switches to emergency mode where the position cannot be accurately controlled anymore. However, the positioner continues operation according to its set point so that the process remains in a safe state.</p>
	Status classification	[Maintenance demanded]
	Recommended action	Return positioner to SAMSON for repair.
63	w too low	<p>The set point w is lower than 3.7 mA. This error arises whenever the power source that drives the positioner does not comply with the standard.</p> <p>This state is indicated on the positioner display by LOW blinking.</p> <p>The positioner goes to the fail-safe position (SAFE).</p>
	Status classification	[No message]
	Recommended action	Check set point. If necessary, adjust the current source's lower limit so that no values lower than 3.7 mA can be applied.
64	i/p converter	Current circuit of i/p converter interrupted. The positioner goes to the fail-safe position (SAFE).
	Status classification	Maintenance alarm (cannot be classified)
	Recommended action	Return positioner to SAMSON for repair.
65	Hardware Additional alarm at the fault alarm contact	<p>Initialization key jammed (firmware version 1.51 and higher)</p> <p>A hardware error has occurred. The positioner changes to the fail-safe position (SAFE).</p>
	Status classification	Maintenance alarm (cannot be classified)
	Recommended action	Confirm error and return to automatic mode or perform a reset. Re-initialize the positioner. In the problem still persists, return device to SAMSON for repair.

Error codes – Recommended action		Condensed state message active, when prompted, Err appears. When fault alarms exist, they are displayed here.
66	Data memory Additional indication at the fault alarm contact	No more data can be written to the memory, e.g. because written data deviate from read data. The valve moves to the fail-safe position (SAFE).
	Status classification	Maintenance alarm (cannot be classified)
	Recommended action	Return device to SAMSON for repair.
67	Test calculation Additional indication at the fault alarm contact	Hardware controller monitored by test calculation.
	Status classification	Maintenance alarm (cannot be classified)
	Recommended action	Confirm error. If this is not possible, return the device to SAMSON for repair.

Data errors

Error codes – Recommended action		Condensed state message active, when prompted, Err appears. When fault alarms exist, they are displayed here.
68	Control parameters Additional indication at the fault alarm contact	Error in control parameters.
	Status classification	[Maintenance required]
	Recommended action	Confirm error. Perform a reset. Re-initialize the positioner.
69	Potentiometer parameters Additional indication at the fault alarm contact	Error in digital potentiometer parameters
	Status classification	[Maintenance required]
	Recommended action	Confirm error. Perform a reset. Re-initialize the positioner.

Error codes – Recommended action		Condensed state message active, when prompted, Err appears. When fault alarms exist, they are displayed here.
70	Calibration parameters Additional indication at the fault alarm contact	Error in data from production calibration. The positioner continues operation with cold start values.
	Status classification	[Maintenance required]
	Recommended action	Return device to SAMSON for repair.
71	General parameters	Error in parameters not critical to control operation.
	Status classification	[Maintenance required]
	Recommended action	Confirm error. Check and, if necessary, change the settings of the required parameters.
72	Start-up parameters	Error in start-up parameters
	Status classification	[Maintenance required]
	Recommended action	Confirm error and perform a reset. Re-initialize the positioner.
73	Internal device error 1	Internal device error
	Status classification	[Maintenance required]
	Recommended action	Return device to SAMSON for repair.
74	HART® parameters	Error in parameters not critical to control operation.
	Status classification	[Maintenance required]
	Recommended action	Confirm error. Check and, if necessary, change the settings of the required parameters.
75	Info parameters	Error in information parameters not critical to closed-loop control operation.
	Status classification	[Maintenance required]
	Recommended action	Confirm error. Check and, if necessary, change the settings of the required parameters.

Error codes – Recommended action		Condensed state message active, when prompted, Err appears. When fault alarms exist, they are displayed here.
76	No emergency mode	The travel measuring system of the positioner has a self-monitoring function (see Code 62). An emergency mode (open-loop control) is not available for certain actuators, such as double-acting actuators. In this case, the positioner changes to the fail-safe position (SAFE) when a measuring error occurs. During the initialization, the positioner automatically checks whether the actuator has such a function or not.
	Status classification	[No message]
	Recommended action	Merely information, confirm, if necessary. No further action required.
77	Software loading error	When the positioner starts operation for the first time after the voltage has been applied, it carries out a self-test (tEStinG runs across the display). If the positioner loads the wrong program, the valve moves to the fail-safe position (SAFE). It is not possible to make the valve leave this fail-safe position again.
	Status classification	Maintenance alarm (cannot be classified)
	Recommended action	Interrupt current signal and restart the positioner. If not successful, return device to SAMSON for repair.
78	Option parameters	Error in option parameters.
	Status classification	[Maintenance required]
	Recommended action	Return device to SAMSON for repair.

Diagnosis errors

Error codes – Recommended action		Condensed state message active, when prompted, Err appears. When fault alarms exist, they are displayed here.
79	Extended diagnostics	Messages are generated by the EXPERTplus extended diagnostics (▶ EB 8389 on EXPERTplus valve diagnostics).
	Status classification	Maintenance required (cannot be classified)
80	Diagnostic parameters	Errors not critical to closed-loop operation.
	Status classification	Maintenance required (cannot be classified)
81	Reference test canceled	<p>Error occurred during plotting the reference graphs for drive signal y steady-state (d1) or drive signal y hysteresis (d2)</p> <ul style="list-style-type: none"> • Reference test canceled • Reference line for drive signal y steady-state or drive signal y hysteresis was not adopted. <p>Error messages are not yet saved in a non-volatile memory. They cannot be reset.</p>
	Status classification	[Maintenance required]
	Recommended action	Check and, if necessary, perform a new reference test.

12.4 Valve characteristic selection

The characteristics that can be selected in Code 20 are shown in the following in graph form.

i Note

A characteristic can only be defined (user-defined characteristic) using a workstation/operating software (e.g. TROVIS-VIEW).

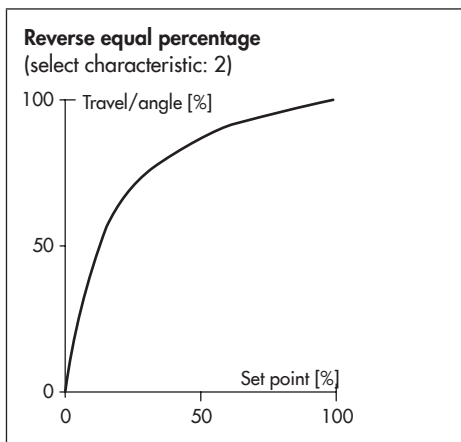
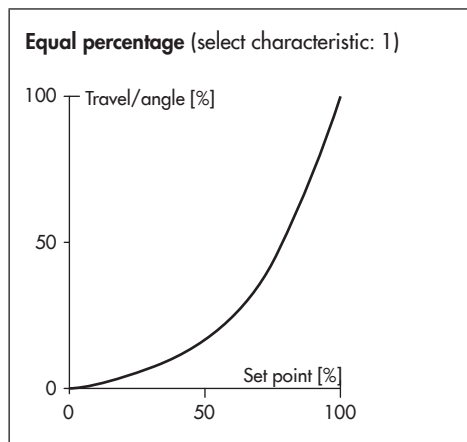
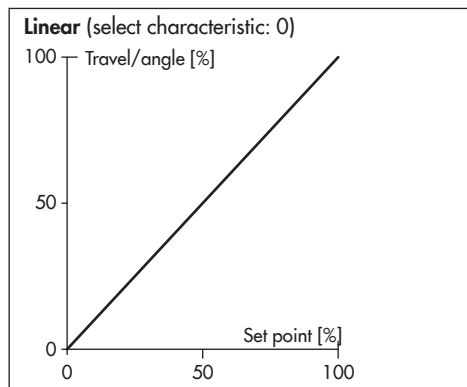

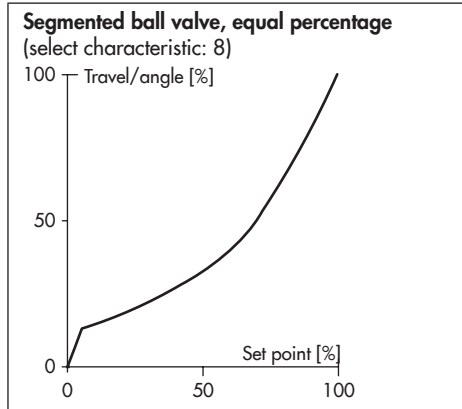
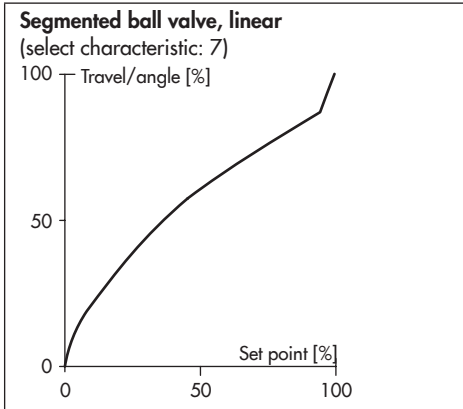
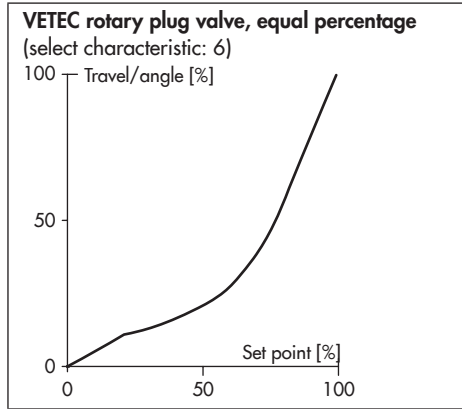
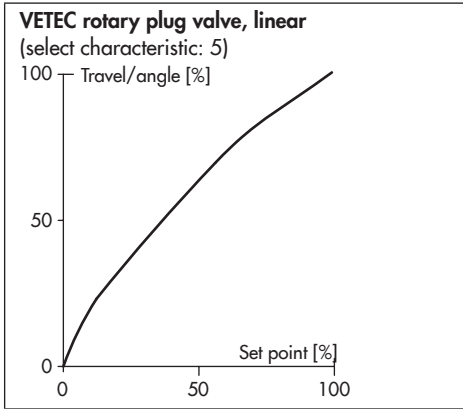
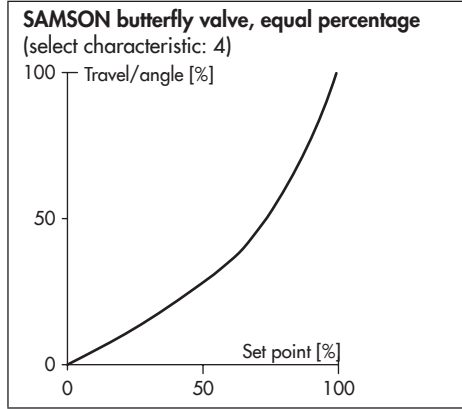
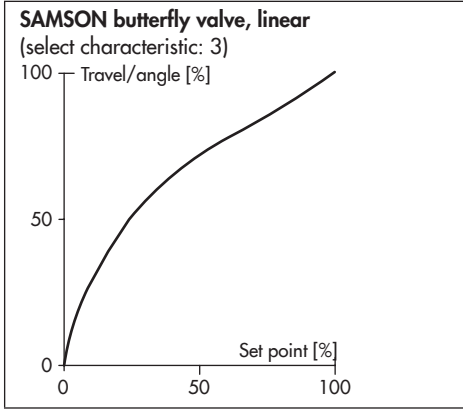



(1) **EU-TYPE EXAMINATION CERTIFICATE**
(Translation)

(2) Equipment or Protective Systems Intended for Use in
Potentially Explosive Atmospheres - **Directive 2014/34/EU**

(3) EU-Type Examination Certificate Number:

PTB 11 ATEX 1014 X

Issue: 01

(4) Product: Electro-pneumatic position controller, type 3731-.21..

(5) Manufacturer: SAMSON AG Mess- und Regeltechnik

(6) Address: Weismüllerstr. 3, 60314 Frankfurt, Germany

(7) This product and any acceptable variation thereto is specified in the schedule to this certificate and the documents therein referred to.

(8) The Physikalisch-Technische Bundesanstalt, notified body No. 0102 in accordance with Article 17 of the Directive 2014/34/EU of the European Parliament and of the Council, dated 26 February 2014, certifies that this product has been found to comply with the Essential Health and Safety Requirements relating to the design and construction of products intended for use in potentially explosive atmospheres, given in Annex II to the Directive.

The examination and test results are recorded in the confidential Test Report PTB Ex 19-18133.

(9) Compliance with the Essential Health and Safety Requirements has been assured by compliance with:

EN IEC 60079-0:2018 EN 60079-1:2014 EN60079-7:2015
EN 60079-11:2012 EN 60079-31:2014

(10) If the sign "X" is placed after the certificate number, it indicates that the product is subject to the Specific Conditions of Use specified in the schedule to this certificate.

(11) This EU-Type Examination Certificate relates only to the design and construction of the specified product in accordance to the Directive 2014/34/EU. Further requirements of the Directive apply to the manufacturing process and supply of this product. These are not covered by this certificate.

(12) The marking of the product shall include the following:



II 2 G Ex db IIC T6 Gb resp. II 2 G Ex db eb IIC T6 Gb resp.



II 2 G Ex db [ia Ga] IIC T6 Gb resp. II 2 G Ex ia IIC T6 Ga and



II 2 D Ex tb IIIC T80 °C Db

Konformitätsbewertungsstelle, Sektor Explosionsschutz

Braunschweig, April 8, 2019

On behalf of PTB:

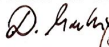
Dr.-Ing. D. Markus
Direktor und Professor



sheet 1/5

EU-Type Examination Certificates without signature and official stamp shall not be valid. The certificates may be circulated only without alteration. Extracts or alterations are subject to approval by the Physikalisch-Technische Bundesanstalt. In case of dispute, the German text shall prevail.

Physikalisch-Technische Bundesanstalt • Bundesallee 100 • 38116 Braunschweig • GERMANY



- (13) **SCHEDULE**
- (14) **EU-Type Examination Certificate Number PTB 11 ATEX 1014 X, Issue: 01**
- (15) Description of Product

The electro-pneumatic position controller, type 3731-*2x (stainless steel=2), is a single- / double-action position controller with communication capabilities, which can be attached to any commercially available lift or part-turn actuator. The position controller compares the output signal of a control unit within the 4 - 20 mA region with the lift of the control valve and adjusts the pneumatic actuating pressure as an output parameter. The position controller is configured and parameterised with a HART protocol, using the signal line of the 4 - 20 mA signal (version 3731-321). Data are transmitted with a superimposed frequency via the 4 - 20 mA signal cables. The 3731-42x and 3731-52x versions are intended for connection to fieldbus systems corresponding to Profibus PA, as well as in accordance with the FOUNDATION™ Fieldbus specification acc. to the FISCO concept.

For field application the apparatuses are installed in a metal enclosure of Ex "d" or Ex "d e" types of protection.

Additionally, the electro-pneumatic positioners of types 3731-421-.....4 and 3731-521-.....4 are designed to type of protection Intrinsic Safety Ex ia. Communication is carried out alternatively according to PROFIBUS PA (type 3731-4.) or FOUNDATION Fieldbus specification (type 3731-5.) acc. to the FISCO-concept.

Types 3731-.2103 / binary input and 3731-.2104 forced breathing are introduced as an option.

The electrical data, shown summarized, are as follows:

Electrical data

Supply voltage:	10 ... 35 V DC, $U_m = 60$ V
Signal circuit:	4 ... 20 mA
Power dissipation:	max. 7.5 W

or

BUS-connection signal circuittype of protection Ex ia IIC/IIB

sheet 2/5

EU-Type Examination Certificates without signature and official stamp shall not be valid. The certificates may be circulated only without alteration. Extracts or alterations are subject to approval by the Physikalisch-Technische Bundesanstalt. In case of dispute, the German text shall prevail.

Physikalisch-Technische Bundesanstalt • Bundesallee 100 • 38116 Braunschweig • GERMANY

SCHEDULE TO EU-TYPE EXAMINATION CERTIFICATE PTB 11 ATEX 1014 X, Issue: 01

For relationship between type of protection and the permissible electrical data reference is made to the following tables.

Type 3731-421.....4

PROFIBUS PA	
Ex ia IIC/IIB	
U_i	= 17.5 V DC
I_i	= 380 mA
P_i	= 5.32 W

or

Type 3731-521.....4

Foundation™ Fieldbus	
Ex ia IIC	Ex ia IIB
U_i = 24 V DC	U_i = 24 V DC
I_i = 380 mA	I_i = 380 mA
P_i = 1.04 W	P_i = 2.58 W

C_i = 5 nF
 L_i = 10 μH

Note: Only one of the following options will be applied in each case.

Option Forced Breathing.....type of protection Ex ia IIC/IIB
(terminals A, B) only for connection to a certified intrinsically safe circuit

Maximum values:

U_i = 28 V
 I_i = 115 mA

or

U_i = 32 V
 I_i = 87.6 mA

C_i = 7.26 nF
 L_i negligibly low

sheet 3/5

EU-Type Examination Certificates without signature and official stamp shall not be valid. The certificates may be circulated only without alteration. Extracts or alterations are subject to approval by the Physikalisch-Technische Bundesanstalt. In case of dispute, the German text shall prevail.

Physikalisch-Technische Bundesanstalt • Bundesallee 100 • 38116 Braunschweig • GERMANY

SCHEDULE TO EU-TYPE EXAMINATION CERTIFICATE PTB 11 ATEX 1014 X, Issue: 01

Option Binary Input type of protection Ex ia IIC/IIB
 (terminals A, B, C) only for connection to a certified intrinsically safe circuit

Maximum values:

$U_i = 25 \text{ V}$
 $I_i = 150 \text{ mA}$
 $C_i = 110 \text{ nF}$
 L_i negligibly low

Changes with respect to further issues

1. Adaptation to the standard issues, mentioned on the cover sheet.
2. In addition to the hitherto used enclosure material Aluminium EN AC-44300DF, in the future may be also used Stainless steel 1.4408 for the electronics compartment and Stainless steel 1.4409 for the terminal compartment.
3. Various design and production-orientated changes to ensure an increased mechanical stability of the enclosure elements.

(16) Test Report PTB Ex 19-18133

(17) Specific conditions of use

Repairs on flameproof joints may only be performed in accordance with the manufacturer's design specifications. Repair on the basis of the values in table 3 of EN 60079-1:2014 resp. IEC 60079-1:2014 is not permitted.

Additional notes for safe operation:

Connection conditions

1. When the terminal compartment of the electro-pneumatic position controller, type 3731-*21, 3731-*22, is designed to Ex-"d" type of protection, the following must be complied with:
 - The device shall be connected with suitable cable glands or conduit systems that meet the requirements stipulated in EN 60079-1, sections 13.1 and 13.2, and for which a separate test certificate has been issued. If the device is connected to conduit systems, the required sealing device shall be provided immediately at the enclosure.
 - Cable glands (Pg type glands) and blanking plugs of a simple design must not be used.
 - Openings that are not used shall be sealed in compliance with the specifications in EN 60079-1, section 11.9.
 - If connection is made in the potentially explosive area, the connecting cable (unconnected cable end) of the electro-pneumatic position controller, type 3731-*21, 3731-*22, shall be connected in an enclosure that meets the requirements of an approved type of protection in accordance with EN 60079-0, section 1.
2. The connecting cable of the electro-pneumatic position controller, type 3731-*21, 3731-*22, shall be fixed and routed so that it will be adequately protected against mechanical damage.
3. If the temperature at the input parts exceeds 70 °C, temperature-resistant connecting cables shall be used.

sheet 4/5

EU-Type Examination Certificates without signature and official stamp shall not be valid. The certificates may be circulated only without alteration. Extracts or alterations are subject to approval by the Physikalisch-Technische Bundesanstalt. In case of dispute, the German text shall prevail.

Physikalisch-Technische Bundesanstalt • Bundesallee 100 • 38116 Braunschweig • GERMANY

SCHEDULE TO EU-TYPE EXAMINATION CERTIFICATE PTB 11 ATEX 1014 X, Issue: 01

4. The electro-pneumatic position controller, type 3731-*21, 3731-*22, shall be included in the local equipotential bonding system of the potentially explosive area.
5. The design version type 3731-.22 (stainless steel) is not allowed for the type of protection Ex de, Ex d [ia] and Ex ia.
6. The design version type 3731-.22 shall only be used in the type of protection Ex db according to EN 60079-1.

These notes and instructions shall accompany each device in an adequate form.

Components attached or installed (terminal compartments, bushings, Ex-type cable glands, connectors) shall be of a technical standard that complies as a minimum with the specifications on the cover sheet, and they shall have a separate examination certificate. The operating conditions specified in the component certificates must be complied with.

Ambient temperature

The field of application of the electro-pneumatic position controller, type 3731-*21, 3731-*22, is as follows:

in temperature class T6: to ambient temperatures between -40 °C and +60 °C,
in temperature class T5: to ambient temperatures between -40 °C and +70 °C, and
in temperature class T4: to ambient temperatures between -40 °C and +80 °C.

Operating medium in the pneumatic section

1. The maximum ingoing-air pressure is 6 bar.
2. The equipment operator must ensure that the operating medium does not form an explosive atmosphere, i.e. the gases used must not contain any substances whose presence in the medium may cause an explosive atmosphere (no flammable gases, no oxygen or oxygen-enriched gas).

(18) Essential health and safety requirements

Met by compliance with the aforementioned standards.

According to Article 41 of Directive 2014/34/EU, EC-type examination certificates which have been issued according to Directive 94/9/EC prior to the date of coming into force of Directive 2014/34/EU (April 20, 2016) may be considered as if they were issued already in compliance with Directive 2014/34/EU. By permission of the European Commission supplements to such EC-type examination certificates and new issues of such certificates may continue to hold the original certificate number issued before April 20, 2016.

Konformitätsbewertungsstelle, Sektor Explosionsschutz
On behalf of PTB:

Braunschweig, April 8, 2019

Dr.-Ing. D. Markus
Direktor und Professor



sheet 5/5

EU-Type Examination Certificates without signature and official stamp shall not be valid. The certificates may be circulated only without alteration. Extracts or alterations are subject to approval by the Physikalisch-Technische Bundesanstalt. In case of dispute, the German text shall prevail.

Physikalisch-Technische Bundesanstalt • Bundesallee 100 • 38116 Braunschweig • GERMANY



EU Konformitätserklärung / EU Declaration of Conformity / Déclaration UE de conformité

Die alleinige Verantwortung für die Ausstellung dieser Konformitätserklärung trägt der Hersteller/
This declaration of conformity is issued under the sole responsibility of the manufacturer/
La présente déclaration de conformité est établie sous la seule responsabilité du fabricant.
Für das folgende Produkt / For the following product / Nous certifions que le produit

Elektropneumatischer Ex d Stellungsregler mit HART-Kommunikation / Electropneumatic Ex d Positioner with HART communication / Positionneur électropneumatique Ex d avec communication HART Typ/Type/Type 3731-3...

wird die Konformität mit den einschlägigen Harmonisierungsrechtsvorschriften der Union bestätigt /
the conformity with the relevant Union harmonisation legislation is declared with/
est conforme à la législation d'harmonisation de l'Union applicable selon les normes:

EMC 2014/30/EU	EN 61000-6-2:2005, EN 61000-6-3:2007 +A1:2011, EN 61326-1:2013
RoHS 2011/65/EU	EN 50581:2012

Hersteller / Manufacturer / Fabricant:

SAMSON AKTIENGESELLSCHAFT
Weismüllerstraße 3
D-60314 Frankfurt am Main
Deutschland/Germany/Allemagne

Frankfurt / Francfort, 2017-07-29

Im Namen des Herstellers/ On behalf of the Manufacturer/ Au nom du fabricant.

Hanno Zager
Leiter Qualitätssicherung/Head of Quality Management/
Responsable de l'assurance de la qualité

Dirk Hoffmann
Zentralabteilungsleiter/Head of Department/Chef du département
Entwicklungsorganisation/Development Organization

es_3731-3_de_en_fr_en07.pdf



**EU Konformitätserklärung / EU Declaration of Conformity /
Déclaration UE de conformité**

Die alleinige Verantwortung für die Ausstellung dieser Konformitätserklärung trägt der Hersteller/
This declaration of conformity is issued under the sole responsibility of the manufacturer/
La présente déclaration de conformité est établie sous la seule responsabilité du fabricant.
Für das folgende Produkt / For the following product / Nous certifions que le produit

**Elektropneumatischer Ex d Stellungsregler mit HART-Kommunikation /
Electropneumatic Ex d Positioner with HART communication /
Positionneur électropneumatique Ex d avec communication HART
Typ/Type/Type 3731-321..**

entsprechend der EU-Baumusterprüfbescheinigung PTB 05 ATEX 1058 ausgestellt von der/
according to the EU Type Examination PTB 05 ATEX 1058 issued by/
établi selon le certificat CE d'essais sur échantillons PTB 05 ATEX 1058 émis par:

Physikalisch Technische Bundesanstalt
Bundesallee 100
D-38116 Braunschweig
Benannte Stelle/Notified Body/Organisme notifié 0102

wird die Konformität mit den einschlägigen Harmonisierungsrechtsvorschriften der Union bestätigt /
the conformity with the relevant Union harmonisation legislation is declared with/
est conforme à la législation d'harmonisation de l'Union applicable selon les normes:

EMC 2014/30/EU

EN 61000-6-2:2005, EN 61000-6-3:2007
+A1:2011, EN 61326-1:2013

Explosion Protection 94/9/EC (bis/to 2016-04-19)
Explosion Protection 2014/34/EU (ab/from 2016-04-20)

EN 60079-0:2006, EN 60079-1:2007,
EN 60079-7:2007, EN 61241-0:2006,
EN 61241-1:2004

RoHS 2011/65/EU

EN 50581:2012

Hersteller / Manufacturer / Fabricant:

SAMSON AKTIENGESELLSCHAFT
Weismüllerstraße 3
D-60314 Frankfurt am Main
Deutschland/Germany/Allemagne

Frankfurt / Francfort, 2017-07-29

Im Namen des Herstellers/ On behalf of the Manufacturer/ Au nom du fabricant.

Hanno Zager
Leiter Qualitätssicherung/Head of Quality Management/
Responsable de l'assurance de la qualité

Dirk Hoffmann
Zentralabteilungsleiter/Head of Department/Chef du département
Entwicklungsorganisation/Development Organization



СЕРТИФИКАТ СООТВЕТСТВИЯ

№ ЕАЭС RU C-DE.ЭА11.В.00045/19

Серия **RU** № **0197354**

ОРГАН ПО СЕРТИФИКАЦИИ Общества с ограниченной ответственностью «ТМС РУС». Место нахождения (адрес юридического лица): Российская Федерация, 127083, город Москва, улица Верхняя Масловка, дом 20, строение 2; адрес места осуществления деятельности: Российская Федерация, 127083, город Москва, улица Верхняя Масловка, дом 20, строение 2, помещения № 18, 28. Аттестат аккредитации № РОСС RU.0001.11ЭА11 от 02.07.2015. Номер телефона: +7 (495) 221-18-04; адрес электронной почты: info@tms.ru.

ЗАЯВИТЕЛЬ Общество с ограниченной ответственностью «Самсон Контролс». Место нахождения (адрес юридического лица) и адрес места осуществления деятельности: Российская Федерация, 109544, город Москва, бульвар Энтузиастов, дом 2, этаж 5, комната 11. ОГРН 1037700041026. Номер телефона: +7 (495) 777-45-45; адрес электронной почты: samson@samson.ru.

ИЗГОТОВИТЕЛЬ «SAMSON AG Mess- und Regeltechnik». Место нахождения (адрес юридического лица) и адрес места осуществления деятельности по изготовлению продукции: Weismullerstrasse 3, D-60314 Frankfurt am Main, Германия.

ПРОДУКЦИЯ Позиционеры, типы 3724, 3725, 3730-0, 3730-1, 3730-2, 3730-3, 3730-4, 3730-5, 3730-6, 3731-3, 3731-5, 4763, 4765. Изготовление в соответствии со стандартами, указанными в приложении к сертификату соответствия на бланке № 0676628. Серийный выпуск.

КОД ТН ВЭД ЕАЭС 9032 81 00 0

СООТВЕТСТВУЕТ ТРЕБОВАНИЯМ технического регламента Таможенного союза «Электромагнитная совместимость технических средств» (ТР ТС 020/2011)

СЕРТИФИКАТ СООТВЕТСТВИЯ ВЫДАН НА ОСНОВАНИИ протокола сертификационных испытаний № 190919-013-016-02/ИР от 22.10.2019, выданного испытательной лабораторией Общества с ограниченной ответственностью «Иновационные решения», аттестат аккредитации РОСС RU.0001.21AB90; акта о результатах анализа состояния производства № 00062-A от 04.07.2019 органа по сертификации Общества с ограниченной ответственностью «ТМС РУС»; руководств по эксплуатации 4218-3725-3724-2018.РЭ, 4218-3730-4763-2018.РЭ, 4218-3731-2018.РЭ. Схема сертификации – 1с.

ДОПОЛНИТЕЛЬНАЯ ИНФОРМАЦИЯ Стандарт, в результате применения которого на добровольной основе обеспечивается соблюдение требований технического регламента: подразделы 6.2 и 7.2 ГОСТ Р 51522.1-2011 (МЭК 61326-1:2005) «Электрометрическое оборудование для измерения, управления и лабораторного применения. Часть 1. Общие требования и методы испытаний». Назначенный срок службы – 15 лет. Назначенный срок хранения – 2 года. Условия хранения указаны в руководствах по эксплуатации 4218-3725-3724-2018.РЭ, 4218-3730-4763-2018.РЭ, 4218-3731-2018.РЭ.

СРОК ДЕЙСТВИЯ С 05.11.2019 **ПО** 04.11.2024

ВКЛЮЧИТЕЛЬНО

Руководитель (уполномоченное лицо) органа по сертификации

Эксперт (эксперт-аудитор) (эксперты (эксперты-аудиторы))

Назарова
(подпись)

Назарова Лилия Юрьевна
(ф.и.о.)

Ходоров Владимир Игоревич
(ф.и.о.)



ПРИЛОЖЕНИЕ

К СЕРТИФИКАТУ СООТВЕТСТВИЯ № ЕАЭС RU C-DE.ЭА11.В.00045/19

Серия **RU** № **0676628** Лист 1 из 1

Стандарты, в соответствии с которыми изготавливается продукция

Обозначение стандарта	Наименование стандарта
IEC 61000-6-2:2016	Electromagnetic compatibility (EMC). Part 6-2: Generic standards. Immunity for industrial environments
EN 61000-6-3:2007	Electromagnetic compatibility (EMC). Part 6-3: Generic standards. Emission standard for residential, commercial and light-industrial environments
EN 61326-1:2013	Electrical equipment for measurement, control and laboratory use. EMC requirements. Part 1: General requirements

Руководитель (уполномоченное
лицо) органа по сертификации

Л.Ю.
(подпись)

Назарова Лилия Юрьевна
(Ф.И.О.)

Эксперт (эксперт-аудитор)
(эксперты (эксперты-аудиторы))

В.И.
(подпись)

Ходоров Владимир Игоревич
(Ф.И.О.)



EB 8387-3 EN



SAMSON AKTIENGESELLSCHAFT
Weismüllerstraße 3 · 60314 Frankfurt am Main, Germany
Phone: +49 69 4009-0 · Fax: +49 69 4009-1507
samson@samsongroup.com · www.samsongroup.com