

L1800FD DSP power amplifier 2x950W



- Live performance DSP amplifier.
- Fully integrated professional speaker processing with FIR Drive technology.
- Market leading acoustic performance and rock solid reliability.
- True 2 ohm stability.
- SONICUE Sound System Software* makes setup and control easy.

*) Requires firmware version 2.x or higher

Technical specifications

Load Impedance	2 Ω	2.6 Ω	4 Ω	8 Ω
Maximum Output Power, Single Channel¹	1600 W	1300 W	950 W	480 W
Maximum Output Power, Dual Channel¹	1400 W	1200 W	850 W	450 W
Maximum Output Power, Bridged¹	-	-	2800 W	1700 W
Maximum RMS Voltage Swing THD = 1%, 1 kHz		65.1 V		
Voltage Gain Ref. 1 kHz		32.0 dB		
THD at 600 W/4 Ω MBW = 80 kHz, 1 kHz		< 0.05%		
IMD-SMPTE, 60 Hz, 7 kHz		< 0.1%		
DIM30, 3.15 kHz, 15 kHz		< 0.05%		
Maximum Input Level		+21 dBu		
Crosstalk ref. 1 kHz, at 100 W/4 Ω		< -80 dB		

Load Impedance	2 Ω	2.6 Ω	4 Ω	8 Ω
Frequency Response, ref. 1 kHz	10 Hz to 21 kHz (±1 dB)			
Input Impedance, Active Balanced	20 k Ω			
Signal to Noise Ratio Amplifier, A-weighted, ref to Max. Output Power @ 8 Ω	>105 dB			
Output Noise, A-weighted	< -68 dBu			
Output Stage Topology	Class AB			
Power Requirements²	240 V, 230 V, 120 V or 100 V; 50 Hz to 60 Hz (factory configured)			
Power Consumption 1/8 Maximum Output Power @ 4 Ω	700 W			
Mains Fuse	240 V/230 V: T12AH; 120 V/100 V: T25AH			
Protection	Audio limiters, high temperature, DC, HF, Back-EMF, Peak current limiters, Inrush current limiters, Turn on delay, Short-circuit			
Cooling	Front-to-rear, 3-stage-fans			

Load Impedance	2 Ω	2.6 Ω	4 Ω	8 Ω
Ambient Temperature Limits	+5°C to +40°C (40°F to +105°F)			
Safety Class	I			
Color	Black			
Dimensions (W x H x D), mm	483 x 88 x 462.4			
Weight	15.2 kg (33.5 lb)			

Load Impedance	2 Ω	2.6 Ω	4 Ω	8 Ω
Signal Processing	FIR Filters, Audio Limiters Output delay per channel, PEQ per channel, Load impedance			
Accessories	RMK15 (rear rack mount kit), SONICUE Sound System software			
1) Test signal for max. output power according IHF-A-202 (Dynamic-Headroom, burst 1 kHz/20 ms on/480 ms off/low level -20 dBu).				
2) Mains power range +/- 10%, max. output might not be achieved below rated mains power.				

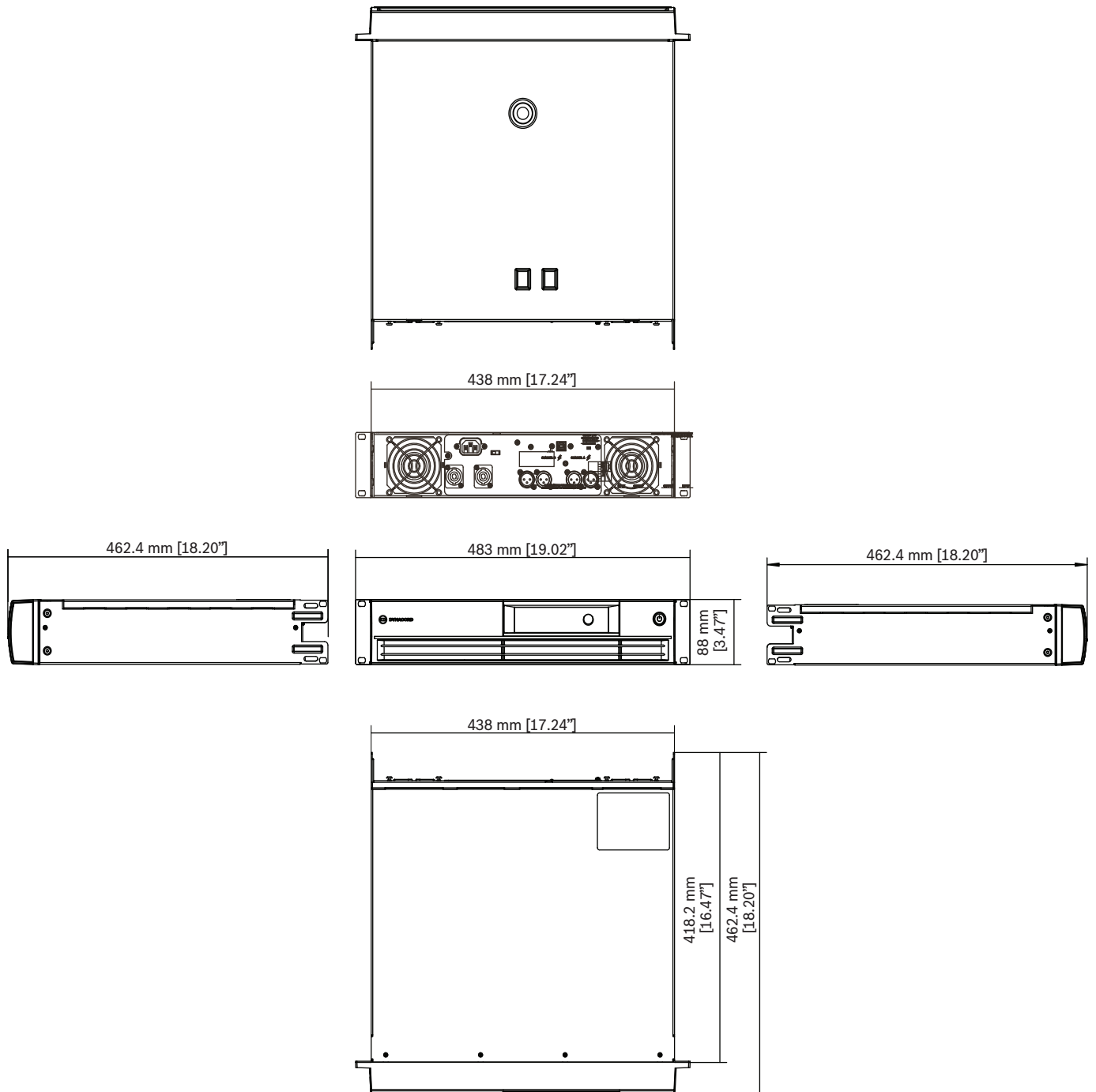

Fig. 1: Dimensions

SAFETY COMPONENT MUST BE REPLACED BY ORIGINAL PARTS

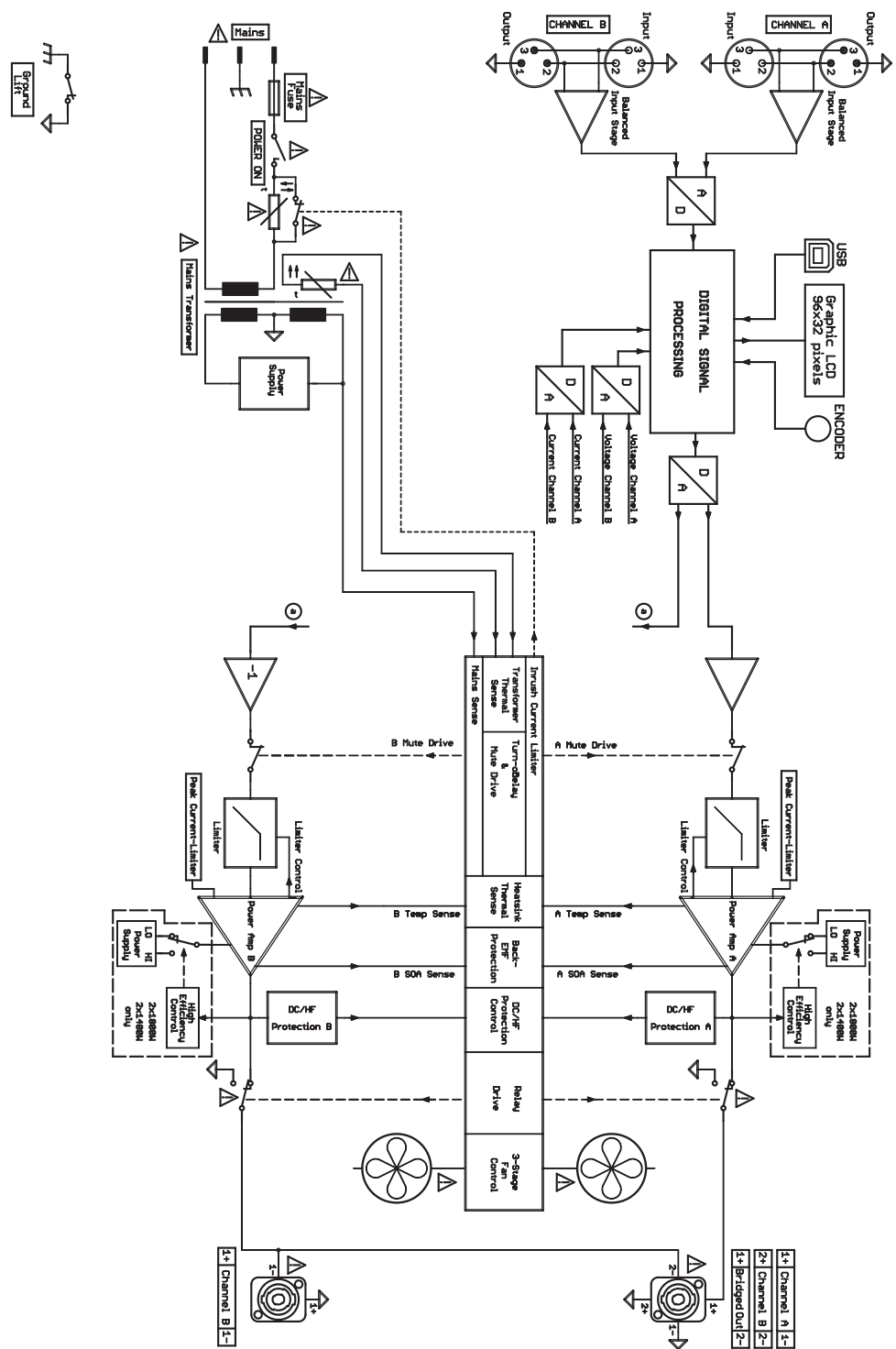

Fig. 2: Block diagram

Ordering information

L1800FD-CN DSP power amplifier 2x950W CN
 DSP power amplifier 2 x 950W @ 4 ohms with FIR Drive, black, Chinese region
 Order number **L1800FD-CN | F.01U.312.388**

L1800FD-EU DSP power amplifier 2x950W EU
 DSP power amplifier 2 x 950W @ 4 ohms with FIR Drive, black, European region
 Order number **L1800FD-EU | F.01U.312.387**

L1800FD-JP DSP power amplifier 2x950W JP
 DSP power amplifier 2 x 950W @ 4 ohms with FIR Drive, black, Japanese region
 Order number **L1800FD-JP | F.01U.312.390**

L1800FD-UK DSP power amplifier 2x950W UK
 DSP power amplifier 2 x 950W @ 4 ohms with FIR Drive, black, UK region
 Order number **L1800FD-UK | F.01U.322.273**

L1800FD-US DSP power amplifier 2x950W US

DSP power amplifier 2 x 950W @ 4 ohms with FIR Drive,
black, North American region

Order number **L1800FD-US | F.01U.312.389**

Accessories

DC-RMK15 Rear rackmount kit for amplifiers

Rack Mount Kit for amplifiers, Length 15,5“; 1L/1R

Order number **DC-RMK15 | F.01U.135.402**

Represented by:

Germany:

Bosch Sicherheitssysteme GmbH
Robert-Bosch-Ring 5
85630 Grasbrunn
Germany
www.dynacord.com

Bosch Security Systems, LLC
130 Perinton Parkway
Fairport, NY 14450
USA