

5000-50.0530.2H
MMSB06-03-06G-A

CETOP MODULAR VERSION

CETOP 03 (NG06)

P max.:250 bar

Q max.:60l/min

Material: Aluminum

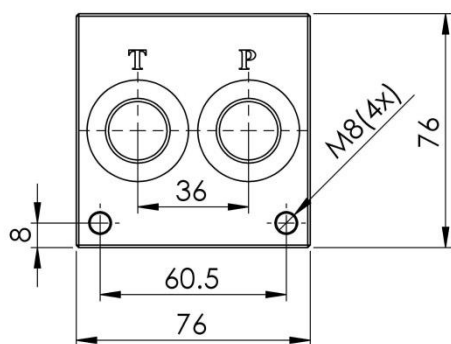
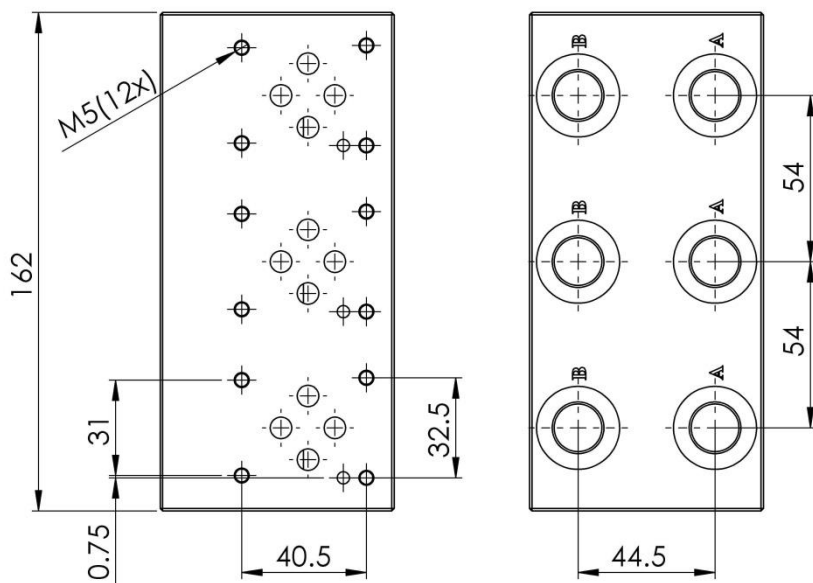

Oil circuit

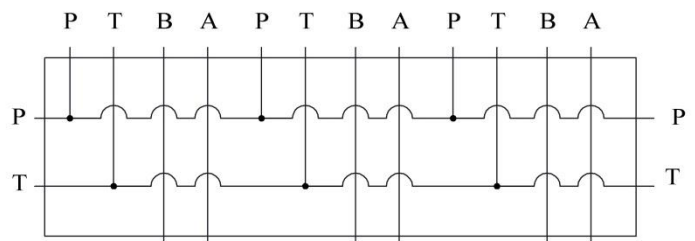

TYPE	P(BSPP)	T(BSPP)	A(BSPP)	B(BSPP)	Wt. Approx.(kg)
MMSB06-03-06-GA	1/2"	1/2"	3/8"	3/8"	2.3

HYDRAULIC FLUIDS

Use mineral oil-base hydraulic fluids, with suitable anti-frothing and anti-oxidizing agents.